



# Table of Contents

Table of Contents	1
About Carbosynth	2
How to Use this Catalogue	4
Key to Product Listing	5
Product Usage	5
How to Order	6
Prices	7
Alphabetical Listing	8
Formula Index	387
CAS Index	405
Product Code Index	415
Acyclic and Cyclic Aldoses	423
Ring Numbering System	427
Catalogue Abbreviations	429
Journal Abbreviations	430
Terms of Sale	434



進階生物科技股份有限公司

服務專線: 0800-251302

The Source for **Carbohydrates and Nucleosides**



# About Carbosynth

Carbosynth is a specialist chemical company primarily working in the fields of carbohydrates, nucleosides and fine chemicals. We aim to offer a broad range of products to the international R&D communities in the following catalogues:

**Enzyme Substrate and Detergent Catalogue**

**Monosaccharide Catalogue**

**Oligosaccharide Catalogue**

**Polysaccharide Catalogue and Handbook**

**Nucleoside Catalogue**

**Impurity and Metabolite Catalogue**

**Fine Chemical Catalogue (CD format)**

**Full Product Catalogue (CD format)**

The catalogues have over **30,000** products, of which over half are in stock. Although our catalogue listings are for R&D quantities, many are produced in bulk or can be scaled-up so we are happy to quote for semi-bulk and bulk quantities.

In our labs we synthesise many of the more complex catalogue products as well as undertaking custom synthesis work. Our focus is on the synthesis of complex carbohydrate building blocks, glucuronides, nucleosides, phosphoramidites, mono- and tri-phosphates. In addition we offer a range of fine chemicals, many of which are versatile building blocks or have specialist applications ranging from biochemical reagents, API impurities, diagnostic reagents to natural antioxidants. The core technologies include the synthesis of unnatural sugars and nucleosides that are of increasing interest to pharmaceutical and biotech discovery programs. We also have experience in a wide range of protection and activation strategies.

The Source for **Carbohydrates and Nucleosides**

In 2017 we opened new laboratories at our Compton site to support the growing demand from our clients for custom synthesis. Our team of scientists are highly motivated and committed to providing in-time development and delivery of quality compounds. If the product you require is not included in the catalogue please ask us to quote on a custom synthesis basis.



The Source for **Carbohydrates and Nucleosides**



## How to Use this Catalogue

Products within this catalogue are listed alphabetically by systematic name. Prefixes such as bis, tris, tetra are considered to be part of the alphabetical name whereas numerical, elemental and stereochemical identifiers are not. For example 5-O-(tert-Butyldimethylsilyl)-2,3-O-isopropylidene-D-ribofuranose appears in the B's section.

Commonly used names and acronyms can also be found in the alphabetical listing and are cross-referenced to their systematic name.

For example Water Soluble Carbodiimide and its acronyms WSC, EDAC, EDC are all listed alphabetically and cross-referenced to 1-(3-Dimethylaminopropyl)-3-ethylcarbodiimide HCl.

It is also possible to find a product if you know its Chemical Abstracts Service Registry Number (CAS), its formula or its Carbosynth product code. The CAS Index is arranged in ascending order and cross-referenced to the alphabetical list. In some unusual cases where we feel that a product has more than one commonly used CAS, then all appear in the CAS Index cross-referenced to the alphabetical list. The Carbosynth Product Code Index is arranged in ascending alphanumeric order and cross-referenced to the alphabetical list.

If the product that you require is not listed in the catalogue please enquire as we may have updated our product list since the publication of the catalogue. We may also be able to offer the product you require as a custom synthesis.



# Key to Product Listing

Product Name —● Isopropyl b-D-thiogalactopyranoside - non-animal origin

Synonym or Acronym —● • IPTG non-animal origin

CAS Registry Number —● [367-93-1] C<sub>9</sub>H<sub>18</sub>O<sub>5</sub>S 238.30

Product Code —● EI05931

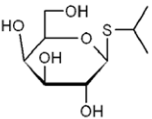
Structure —● 

Product Grade —●

Formula —●

Formula Weight —●

10g	\$35.00	● Prices
25g	\$60.00	
50g	\$95.00	

Typical Pack Size —●

Refs: Lama J, et al, Gene 1992, 117, 185; Zhang Y, Moss B, Natl. Acad. Sci. USA, 1991, 88, 1511; Rodriguez JF, Smith GL, Nucleic Acids Res. 1990, 18, 5347; Date T, et al, Biochem. Biophys. Res. Commun. 1988, 151, 598; Lee SG, et al, Biochemistry 1988, 27, 2983

# Product Usage

Carbosynth's products are intended for research purposes only. They are not to be used for any other purposes including, but not limited to, usage in drugs, cosmetics or foodstuffs. The purchaser has the responsibility to independently verify hazards and risks associated with handling or using products purchased from Carbosynth and ensure that the purchaser's employees and any associates who come into contact with the products understand these hazards and risks.

The Source for **Carbohydrates and Nucleosides**



## How to Order

To place an order or make a product enquiry please contact us by phone, fax, email or post. Our contact details are as follows:

### **Carbosynth Limited**

Axis House, High Street  
Compton, Berkshire  
RG20 6NL. United Kingdom

☎ 44 1635 578444

☎ 44 1635 579444

✉ orders@carbosynth.com

### **Carbosynth US LLC**

7887 Dunbrook Road, Suite F  
San Diego, CA 92126. USA

☎ 888-681-2933 (toll-free)

☎ 858-779-9911

☎ 858-605-0807

✉ sales@carbosynth.com

### **Carbosynth China Ltd**

Suite 421, Building A2  
218 Xinghu Street  
Suzhou Industrial Park  
215123. China

☎ 86 512 6260 5585

☎ 86 512 6260 5576

✉ sales@carbosynth.com

### **Carbosynth India**

T-1. Block 2, Jains KK Gardens  
Vembuli Amman Kovil Street  
West KK Nager  
Chennai 600 078. India

☎ 91 44 420 16316

✉ enquiries@carbosynth.com

On-line ordering and payment can be made by credit card at [www.carbosynth.com](http://www.carbosynth.com) or by ringing 44 1635 577667, or for US & Canada 858-779-9911

In all cases, please supply the following information with your purchase order:

- Name of company or organisation
- Delivery address
- Invoice address and VAT number
- Contact name and phone number
- Carbosynth product code
- Purchase order unique reference or number

In the interests of Health and Safety we are unable to supply chemicals to private individuals or residential addresses.

The Source for **Carbohydrates and Nucleosides**



## Prices

All prices are on an EXW basis in US Dollars (\$) and are subject to alteration at any time. Actual transport costs vary and depend on weight, hazard class and destination. Any transport costs and hazardous surcharges are indicated on our invoices and we endeavour to minimise these. A guide to our transport and hazard charge is given below and we will advise you if the costs are higher than those in the table, prior to delivery.

Destination	Gross Weight	Transport Charge	Hazard Charge
Europe*, USA & Canada	< 0.5 kg	\$35	\$75
	0.5 - 2.5 kg	\$50	\$75
	2.5 - 5 kg	\$65	\$75
UK	< 0.5 kg	\$20	\$75
	0.5 - 2.5 kg	\$20	\$75
	2.5 - 5 kg	\$25	\$75
China, Australia, New Zealand, Russia & Ukraine	< 0.5 kg	\$60	\$150
	0.5 - 2.5 kg	\$75	\$150
	2.5 - 5 kg	\$90	\$150
India**	< 0.5 kg	\$45	\$90
	0.5 - 2.5 kg	\$60	\$90
	2.5 - 5 kg	\$80	\$90
Rest of World***	< 0.5 kg	\$60	\$90
	0.5 - 2.5 kg	\$75	\$90
	2.5 - 5 kg	\$90	\$90

\* Additional costs apply to hazardous shipments to Greece, Norway, Poland, Romania and some regions in Spain

\*\* Hazardous shipments are to the following airports only: Mumbai, Hyderabad, Bangalore and New Delhi. An additional cost of \$100 applies to hazardous shipments to Hyderabad airport

\*\*\* Some restrictions apply and some additional costs apply to some territories. These will be advised on request.

Different carriers have different restrictions on the hazardous classes and territories they serve. Our preferred carrier is FedEx, although the actual carrier will depend on the hazard class and the final destination. If you wish to have products shipped by your chosen carrier please include your carrier's name and account number on your purchase order. We reserve the right to alter the method of shipment if we deem that it does not comply with regulations or that the product will not be delivered in good order.

If you wish to purchase in Pounds (£) or EURs (€) please enquire or visit our website.

The Source for **Carbohydrates and Nucleosides**



**5-AA-CTP**

see *5-Aminoallylcytidine 5'-triphosphate lithium salt - 100mM aqueous solution, NA32073 on page 33*

**5-AA-dUTP.Li**

see *5-Aminoallyl 2'-deoxyuridine 5'-triphosphate lithium salt - 100mM aqueous solution, NA32074 on page 34*

**A(5')P5(5')A**

see *Diadenosine pentaphosphate pentasodium salt, ND46856 on page 229*

**Abacavir carboxylate**

• (1S,4R)-4-[2-Amino-6-(cyclopropylamino)-9H-purin-9-yl]-2-cyclopentene-1-carboxylic acid  
• 2269W

[384380-52-3] C<sub>14</sub>H<sub>16</sub>N<sub>6</sub>O<sub>2</sub> 300.32

NA16897

1mg	\$350.00
2mg	\$660.00
5mg	\$1200.00

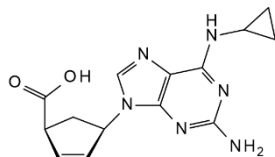

Refs: Hoetelmans, R, et al, Pharm. World Sci, 19, 159

**trans-Abacavir hydrochloride**

• (1R,4R)-rel-4-[2-amino-6-(cyclopropylamino)-9H-purin-9-yl]-2-cyclopentene-1-methanol hydrochloride

[267668-71-3] C<sub>14</sub>H<sub>19</sub>ClN<sub>6</sub>O 322.79

NA16496

Price On Application

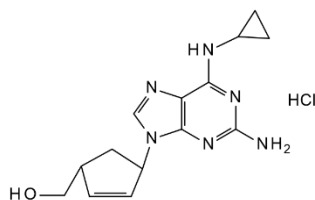

Refs: Foster, R, et al, Drugs, 55, 729 (1998); Hanumegowda, U, et al, Chem. Res. Toxicol, 23, 749 (2010); Prasse, C, et al, Environ. Sci. Technol, 44, 1728 (2010)

**(1S-cis)-Abacavir monophosphate**

see *Abacavir 5'-phosphate, NA16495 on page 9*

**Abacavir 5'-phosphate**

• (1S,4R)-4-[2-Amino-6-(cyclopropylamino)-9H-purin-9-yl]-2-cyclopentene-1-methanol dihydrogen phosphate (ester)  
• (1S-cis)-Abacavir monophosphate

[136470-77-4] C<sub>14</sub>H<sub>19</sub>N<sub>6</sub>O<sub>4</sub>P 366.31

NA16495

1mg	\$318.00
2mg	\$578.10
5mg	\$1051.10

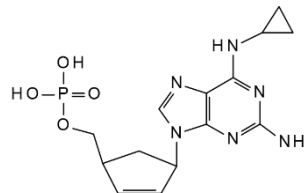

Refs: Faletto, M, et al, Antimicrob. Agents Chemother, 41, 1099

**Abacavir sulfate**

• Abacavir Sulphate

[188062-50-2][136777-48-5] C<sub>14</sub>H<sub>18</sub>N<sub>6</sub>O·½H<sub>2</sub>SO<sub>4</sub> 335.37

NA10019

2g	\$50.00
5g	\$75.00
10g	\$120.00

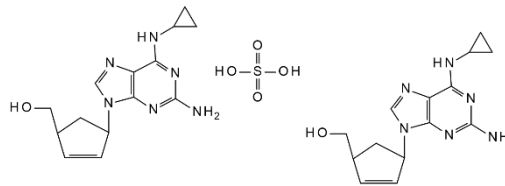

Refs: Staszewski S. et al. , J. Am. Med. Assoc, 2001, 285, p1155

**Abacavir Sulphate**

see *Abacavir sulfate, NA10019 on page 9*

**Abacavir**

[136470-78-5] C<sub>14</sub>H<sub>18</sub>N<sub>6</sub>O 286.33

NA10018

1g	\$65.00
2g	\$110.00
5g	\$200.00

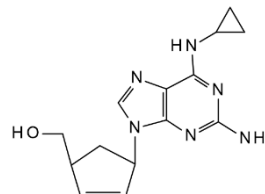

Refs: Zucman D, et.al. , J Acquir Immune Defic Syndr. 2007, 45 p1-3.



**Abacavir****(1R,4S)-Abacavir**see *ent-abacavir*, NE16540 on page 267**Acadesine**see *5-Aminoimidazole-4-carboxamide-1-β-D-ribofuranose*, NA03552 on page 56**2-Acetamido-6-chloro-9-(2',3',5'-tri-O-acetyl-β-D-ribofuranosyl)purine**[137896-02-7] C<sub>18</sub>H<sub>20</sub>ClN<sub>5</sub>O<sub>8</sub> 469.83

NA04442	100mg	\$105.00
	250mg	\$210.00
	500mg	\$395.00

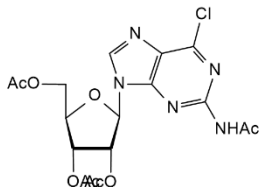

Refs: Kozai S, Yorikane A, Maruyama T, Nucleotides &amp; Nucleic Acids 2001, 20, 8, p1523

**4'-Acetamido-4'-deoxyadenosine**see *1-[2-(6-Aminopurin-9-yl)-3,4-dihydroxy-5-(hydroxymethyl)pyrrolidin-1-yl]ethanone*, NA71841 on page 61**Acetoacetyl-CoANa3 tetrahydrate**see *Acetoacetyl coenzyme A trisodium salt trihydrate*, NA47206 on page 10**Acetoacetyl coenzyme A lithium salt**C<sub>25</sub>H<sub>36</sub>N<sub>7</sub>O<sub>18</sub>P<sub>3</sub>SLi<sub>4</sub>·5H<sub>2</sub>O 965.42

NA48994	5mg	\$150.00
	10mg	\$270.00
	25mg	\$550.00

**Acetoacetyl coenzyme A trisodium salt trihydrate**

• Acetoacetyl-CoANa3 tetrahydrate

[102029-52-7] C<sub>25</sub>H<sub>37</sub>N<sub>7</sub>Na<sub>3</sub>O<sub>18</sub>P<sub>3</sub>S<sub>3</sub>·H<sub>2</sub>O 971.6

NA47206	1mg	\$55.00
	2mg	\$90.00
	5mg	\$150.00

**5-Acetoxyethyl-2'-deoxycytidine**C<sub>12</sub>H<sub>17</sub>N<sub>3</sub>O<sub>6</sub> 299.28

NA12830

500mg

\$3675.00

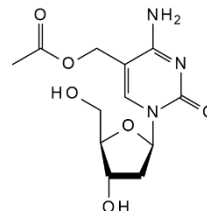
**5-Acetoxyethyl-2'-deoxyuridine**[148380-55-6] C<sub>12</sub>H<sub>16</sub>N<sub>2</sub>O<sub>7</sub> 300.26

NA11237

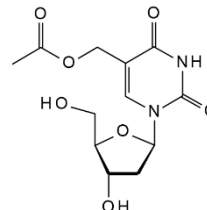
10mg  
25mg  
50mg\$157.50  
\$252.00  
\$378.00**N4-Acetyl-3'-O-acetyl-2'-deoxycytidine**see *3'-O, N4-Diacetyl-2'-deoxycytidine*, ND09207 on page 330**N4-Acetyl-3'-O-acetyl-2'-deoxycytidine**

[70284-47-8]

NA03451

Price On Application



**5'-O-Acetyladenosine**[2140-25-2] C<sub>12</sub>H<sub>15</sub>N<sub>5</sub>O<sub>5</sub> 309.28

NA09588

50mg	\$105.00
100mg	\$189.00
250mg	\$315.00

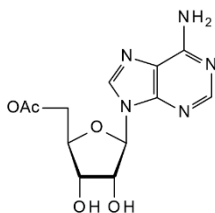

Refs: Ferrero M. et al, Chem. Rev, 2000, 100, p4319

**2'-O-Acetyl-5'-O-benzoyl-3'-deoxy-5-methyluridine**[143653-60-5] C<sub>19</sub>H<sub>20</sub>N<sub>2</sub>O<sub>7</sub> 388.37

NA31581

Price On Application

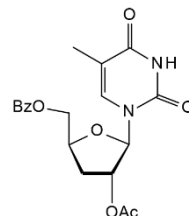
**5'-O-Acetyl-3'-azido-2',3'-dideoxy-N2-palmitoylguanosine**[144742-33-6] C<sub>28</sub>H<sub>44</sub>N<sub>6</sub>O<sub>5</sub> 572.7

NA06399

5mg	\$94.50
25mg	\$236.50
50mg	\$420.00

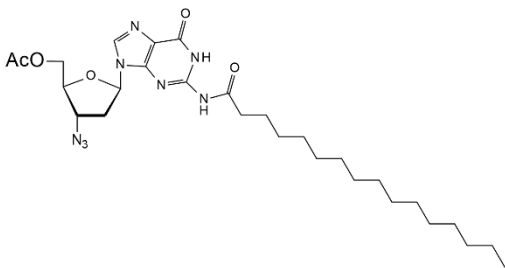
**N-Acetyl-5-[1,2-bis(acetyloxy)ethyl]-5'-O-DMT-2'-deoxycytidine**[364613-33-2] C<sub>47</sub>H<sub>58</sub>N<sub>5</sub>O<sub>12</sub>P 915.96

NA146816

Price On Application

**N4-Acetyl-2'-O-tert-butylidimethylsilyl-cytidine**[119794-51-3] C<sub>17</sub>H<sub>29</sub>N<sub>3</sub>O<sub>6</sub>Si 399.51

NA57543

1g	\$65.00
2g	\$110.00
5g	\$225.00

**2'-O-Acetyl-5'-O-benzoyl-3'-deoxy-3'-C-methyluridine**C<sub>19</sub>H<sub>20</sub>N<sub>2</sub>O<sub>7</sub> 388.37

NA15619

Price On Application

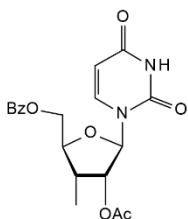
**N4-Acetyl-2'-O-tert-butylidimethylsilylcytidine**[401812-97-3] C<sub>17</sub>H<sub>29</sub>N<sub>3</sub>O<sub>6</sub>Si 399.51

NA71488

Price On Application



## Acetylbutylid

## N4-Acetyl-2'-O-tert-butylidimethylsilyl-5'-O-DMT-cytidine

[121058-85-3] C<sub>38</sub>H<sub>47</sub>N<sub>3</sub>O<sub>8</sub>Si 701.88

NA11979	250mg	\$65.00
	500mg	\$100.00
	1g	\$150.00

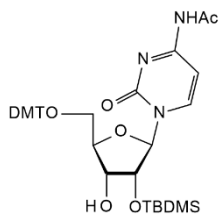

## N4-Acetyl-3'-O-tert-butylidimethylsilyl-5'-O-DMT-cytidine

• 5'-DMT-3'-TBDMS-N4-Ac-rC

[123956-65-0] C<sub>38</sub>H<sub>47</sub>N<sub>3</sub>O<sub>8</sub>Si 701.88

NA15518

Price On Application



## 3'-O-Acetyl-5'-O-tert-butylidiphenylsilyl-2'-deoxy-2'-fluorothymidine

C<sub>28</sub>H<sub>33</sub>FN<sub>2</sub>O<sub>6</sub>Si 540.66

NA08463

10mg	\$94.50
25mg	\$157.50
50mg	\$262.50

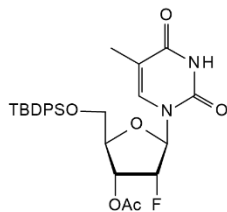

## 2'-O-Acetyl-2-chloro-3'-deoxy-3'-fluoro-5'-O-toluoylinosine

C<sub>20</sub>H<sub>18</sub>ClFN<sub>4</sub>O<sub>5</sub> 448.83

NA15614

Price On Application

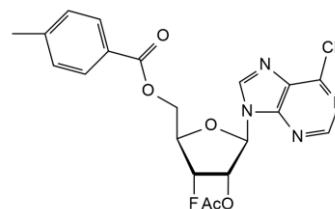

## Acetyl-CoA Li

see *Acetyl coenzyme A lithium salt*, NA45964 on page 12

## Acetyl-S-CoA Li3

see *Acetyl coenzyme A trilithium salt*, NA46990 on page 13

## Acetyl CoA

see *Acetyl coenzyme A sodium salt*, NA15698 on page 12

## Acetyl coenzyme A lithium salt

• Acetyl-CoA Li

[32140-51-5]	C <sub>23</sub> H <sub>38</sub> N <sub>7</sub> O <sub>17</sub> P <sub>3</sub> S <sub>3</sub> Li	809.57 (free acid basis)	
NA45964		5mg	\$85.00
		10mg	\$150.00
		25mg	\$275.00



## Acetyl coenzyme A sodium salt

• Acetyl CoA

[102029-73-2]	C <sub>23</sub> H <sub>38</sub> N <sub>7</sub> O <sub>17</sub> P <sub>3</sub> S <sub>3</sub> xNa	809.57 (free acid basis)	
NA15698		2mg	\$70.00
		5mg	\$145.00
		10mg	\$250.00





**Acetyl coenzyme A trilithium salt**

• Acetyl-S-CoA Li3

[75520-41-1] C<sub>23</sub>H<sub>35</sub>Li<sub>3</sub>N<sub>7</sub>O<sub>17</sub>P<sub>3</sub>S 827.37

NA46990

5mg	\$75.00
10mg	\$125.00
25mg	\$250.00

**3'-O-Acetyl-2'-deoxycytidine**[72560-69-1] C<sub>11</sub>H<sub>15</sub>N<sub>3</sub>O<sub>5</sub> 269.25

NA07943

500mg	\$90.00
1g	\$168.00
5g	\$315.00

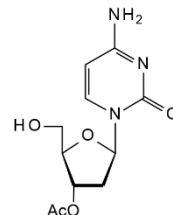
**N4-Acetylcytidine**[3768-18-1] C<sub>11</sub>H<sub>15</sub>N<sub>3</sub>O<sub>6</sub> 285.25

NA05753

5g	\$45.00
10g	\$75.00
25g	\$140.00

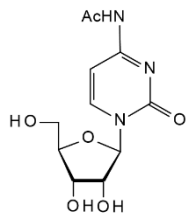

Refs: Stern L, Schulman LH, J. Biol. Chem. 1978, 253, p6132

**N4-Acetyl-2'-deoxycytidine**[32909-05-0] C<sub>11</sub>H<sub>15</sub>N<sub>3</sub>O<sub>5</sub> 269.25

NA08263

25g	\$65.00
50g	\$100.00
100g	\$145.00

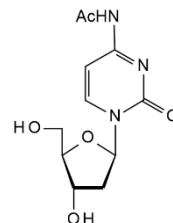
**3'-O-Acetyl-2'-deoxyadenosine**[6612-73-3] C<sub>12</sub>H<sub>15</sub>N<sub>5</sub>O<sub>4</sub> 293.29

NA08525

50mg	\$210.00
100mg	\$394.00
250mg	\$920.00

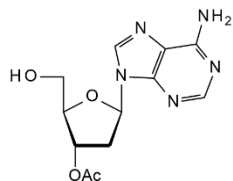
**N2-O-Acetyl-2'-deoxy-3',5'-di-O-acetyl-06-DPC-a-b-guanosine**

NA76382

25mg	\$50.00
50mg	\$90.00
100mg	\$150.00

**N6-Acetyl-2'-deoxyadenosine**C<sub>12</sub>H<sub>15</sub>N<sub>5</sub>O<sub>4</sub> 293.28

NA57527

Price On Application



## Acetyldeoxyd

## 5'-O-Acetyl-2'-deoxy-2',2'-difluorocytidine

• 5'-O-Acetylgemcitabine

C<sub>11</sub>H<sub>13</sub>F<sub>2</sub>N<sub>3</sub>O<sub>5</sub> 305.23

NA10690

1mg	\$95.00
2mg	\$150.00
5mg	\$250.00

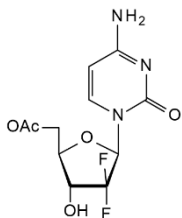

## N6-Acetyl-2'-deoxy-5'-O-DMT-adenosine

C<sub>33</sub>H<sub>33</sub>N<sub>5</sub>O<sub>6</sub> 595.65

NA08597

1g	\$210.00
5g	\$945.00
10g	\$1680.00

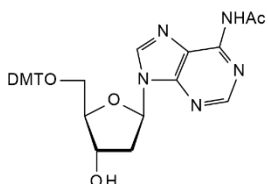

## N6-Acetyl-2'-deoxy-5'-O-DMT-adenosine

• DMT-Ac-dA

C<sub>33</sub>H<sub>33</sub>N<sub>5</sub>O<sub>6</sub> 595.65

ND57508

Price On Application



## N4-Acetyl-2'-deoxy-5'-O-DMT-cytidine 3'-Q linker CPG 1000Å

NA11632

250mg	\$60.00
500mg	\$100.00
1g	\$157.50



## N4-Acetyl-2'-Deoxy-5'-O-DMT-cytidine 3'-succinyl CPG 1000 Å

NA11603

1g \$157.50



## N4-Acetyl-2'-deoxy-5'-O-DMT-cytidine 3'-succinyl CPG 1400 Å

NA11608

1g	\$126.00
5g	\$367.50
10g	\$630.00



## N4-Acetyl-2'-deoxy-5'-O-DMT-cytidine 3'-succinyl CPG 2000 Å

NA09884

1g	\$157.50
5g	\$472.50
10g	\$840.00

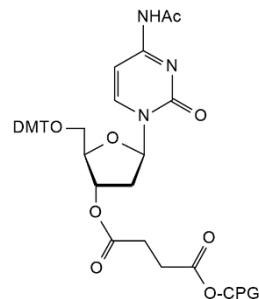

## N4-Acetyl-2'-deoxy-5'-O-DMT-cytidine 3'-succinyl CPG 500 Å

NA10318

1g	\$126.00
5g	\$315.00
10g	\$525.00



**N4-Acetyl-2'-deoxy-5'-O-DMT-cytidine**

• 5'-DMT-N4-acetyl-2'-deoxycytidine

[100898-63-3] C<sub>32</sub>H<sub>33</sub>N<sub>3</sub>O<sub>7</sub> 571.62

NA04015

5g	\$60.00
10g	\$90.00
25g	\$170.00

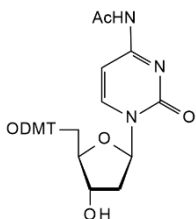
**N4-Acetyl-2'-deoxy-5'-O-DMT-2'-fluorocytidine 3'-O-succinate**

NA145741

25mg	\$50.00
50mg	\$85.00
100mg	\$150.00

**N4-Acetyl-2'-deoxy-5'-O-DMT-2'-fluorocytidine**• 2'-Fluoro-5'-O-DMT-N4-acetyl-cytidine  
• N4-Acetyl-5'-O-DMT-2'-fluoro-2'-deoxycytidine[159414-98-9] C<sub>32</sub>H<sub>32</sub>FN<sub>3</sub>O<sub>7</sub> 589.61

NA06052

500mg	\$65.00
1g	\$95.00
2g	\$160.00

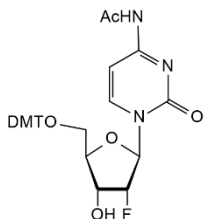
**3'-O-Acetyl-2'-deoxy-5'-O-DMT-2'-fluorouridine**C<sub>32</sub>H<sub>31</sub>FN<sub>2</sub>O<sub>8</sub> 590.6

NA08460

50mg	\$31.50
100mg	\$53.00
250mg	\$105.00

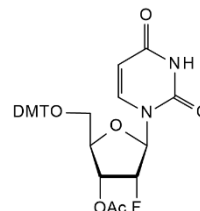
**N4-Acetyl-2'-deoxy-5'-O-DMT-5-iodocytidine**

• DMT-Ac-5-I-2'-deoxycytidine

C<sub>32</sub>H<sub>32</sub>IN<sub>3</sub>O<sub>7</sub> 697.52

ND57519

Price On Application

**N4-Acetyl-2'-deoxy-5'-O-DMT-5-methylcytidine**C<sub>33</sub>H<sub>35</sub>N<sub>3</sub>O<sub>7</sub> 585.65

NA03003

250mg	\$85.00
500mg	\$150.00
1g	\$275.00

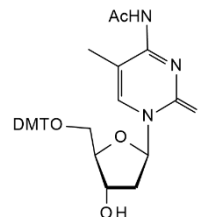

## AcetyldeoxyD

## N4-Acetyl-3'-deoxy-5'-O-DMT-3'-C-methylcytidine

NA15624

Price On Application

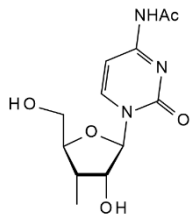

## N4-Acetyl-2'-deoxy-2'-fluorocytidine

[159414-97-8] C<sub>11</sub>H<sub>14</sub>FN<sub>3</sub>O<sub>5</sub> 287.24

NA02623

500mg	\$60.00
1g	\$100.00
2g	\$180.00

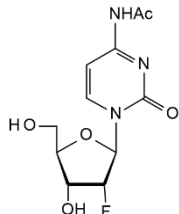

## N4-Acetyl-2'-deoxy-2'-fluoro-2'-C-methylcytidine

NA29438

Price On Application



## 3'-O-Acetyl-2'-deoxy-2'-fluoro-5-methyluridine

C<sub>12</sub>H<sub>15</sub>FN<sub>2</sub>O<sub>6</sub> 302.26

NA08458

50mg	\$63.00
100mg	\$105.00
250mg	\$210.00

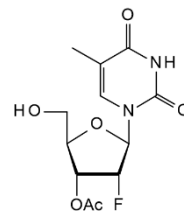

## 2'-O-Acetyl-3'-deoxy-3'-fluoro-5'-O-toluoyluridine

C<sub>19</sub>H<sub>19</sub>FN<sub>2</sub>O<sub>7</sub> 406.36

NA15558

Price On Application

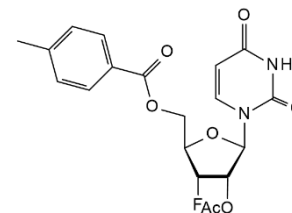

## N-Acetyl-2'-deoxy-guanosine 3',5'-diacetate

see 3',5',N2-Tri-O-acetyl-2'-deoxyguanosine, NT16879 on page 370

## 3'-O-Acetyl-2'-deoxy-N2-isobutyrylguanosine

[74925-81-8] C<sub>16</sub>H<sub>21</sub>N<sub>5</sub>O<sub>6</sub> 379.37

NA76379

50mg	\$85.00
100mg	\$150.00
250mg	\$300.00



**N4-Acetyl-2'-deoxy-5-methylcytidine**C<sub>12</sub>H<sub>17</sub>N<sub>3</sub>O<sub>5</sub> 283.28

NA15219

1g	\$630.00
2g	\$1155.00
5g	\$2362.50

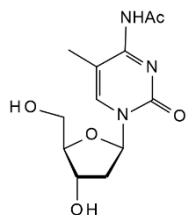
**N4-Acetyl-3'-deoxy-3'-C-methylcytidine**C<sub>12</sub>H<sub>17</sub>N<sub>3</sub>O<sub>5</sub> 283.28

NA15623

Price On Application

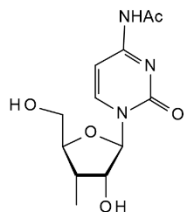
**N4-Acetyl-2'-deoxy-5'-O-tritylcytidine**C<sub>30</sub>H<sub>29</sub>N<sub>3</sub>O<sub>5</sub> 511.57

NA57522

Price On Application

**5'-O-Acetyldidanosine**

see 5'-O-Acetyl-2',3'-dideoxyinosine, NA08461 on page 17

**1-(5'-O-acetyl-2,3-dideoxy-a-D-erythro-pentofuranosyl)uracil**

see 5'-O-Acetyl-2',3'-dideoxy-3'-fluoro-a-uridine, NA02562 on page 17

**5'-O-Acetyl-2',3'-dideoxy-3'-fluoro-cytidine**

• 1-(5'-O-Acetyl-2,3-dideoxy-3-fluoro-b-D-erythro-pentofuranosyl)cytosine

C<sub>11</sub>H<sub>14</sub>FN<sub>3</sub>O<sub>4</sub> 271.25

NA03794

Price On Application

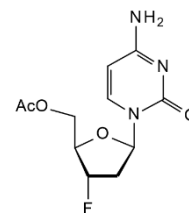
**1-(5'-O-Acetyl-2,3-dideoxy-3-fluoro-b-D-erythro-pentofuranosyl)cytosine**

see 5'-O-Acetyl-2',3'-dideoxy-3'-fluoro-cytidine, NA03794 on page 17

**5'-O-Acetyl-2',3'-dideoxy-3'-fluoro-a-uridine**

• 1-(5'-O-acetyl-2,3-dideoxy-a-D-erythro-pentofuranosyl)uracil

[51247-09-7]

NA02562

Price On Application

**5'-O-Acetyl-2',3'-dideoxyinosine**

• 5'-O-Acetyldidanosine

[130676-58-3] C<sub>12</sub>H<sub>14</sub>N<sub>4</sub>O<sub>4</sub> 278.26

NA08461

Price On Application

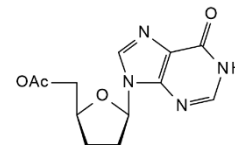

## Acetyldiphen

## N2-Acetyl-O6-diphenylcarbamoyl guanine

A	NA76381	25mg	\$50.00
		50mg	\$90.00
		100mg	\$150.00



## N4-Acetyl-5'-O-DMT-cytidine 3'-succinyl CPG 1000 Å (RNA)

A	NA11629	50mg	\$70.00
		100mg	\$100.00
		250mg	\$150.00



## N4-Acetyl-5'-O-DMT-cytidine

• 5'-O-(4,4'-Dimethoxytrityl)-N4-acetyl-2'-deoxycytidine

[121058-82-0] C<sub>32</sub>H<sub>33</sub>N<sub>3</sub>O<sub>8</sub> 587.63

A	NA11105	5g	\$65.00
		10g	\$125.00
		25g	\$175.00

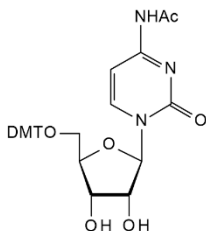

## N4-Acetyl-5'-O-DMT-2'-fluoro-2'-deoxycytidine

see N4-Acetyl-2'-deoxy-5'-O-DMT-2'-fluorocytidine, NA06052 on page 15

## N2-Acetyl-5'-O-DMT-guanosine

A	NA138797	10g	\$250.00
		25g	\$485.00
		50g	\$825.00



## N4-Acetyl-5'-O-DMT-5-iodocytidine

• DMT-Ac-5-I-Cytidine

C<sub>32</sub>H<sub>32</sub>I<sub>2</sub>N<sub>3</sub>O<sub>8</sub> 713.52

ND57520

Price On Application



## 3'-O-Acetyl-5'-O-DMT-5-iodo-2'-O-methyuridine

NA15556

Price On Application

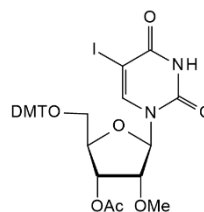

## N4-Acetyl-5'-O-DMT-2'-O-methylcytidine

[199593-08-3] C<sub>33</sub>H<sub>35</sub>N<sub>3</sub>O<sub>8</sub> 601.65

NA03000

1g	\$90.00
2g	\$160.00
5g	\$325.00

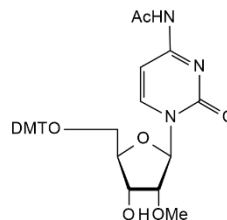

**N4-Acetyl-5'-O-DMT-2'-O-methyl-5-methylcytidine**C<sub>34</sub>H<sub>37</sub>N<sub>5</sub>O<sub>8</sub> 615.67

NA11484

2g	\$590.00
5g	\$975.00
10g	\$1750.00

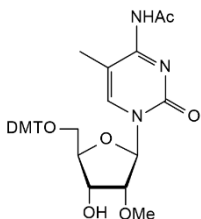
**5'-O-Acetyllamivudine**C<sub>10</sub>H<sub>13</sub>N<sub>5</sub>O<sub>4</sub>S 271.29

NA15183

100mg	\$1500.00
200mg	\$2500.00

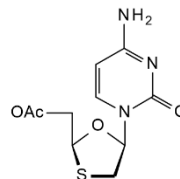
**N4-Acetyl-2'-O-methylcytidine**[113886-71-8] C<sub>12</sub>H<sub>17</sub>N<sub>5</sub>O<sub>6</sub> 299.29

NA08375

100mg	\$60.00
250mg	\$92.50
500mg	\$150.00

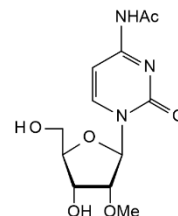
**N-Acetylneuraminic acid aldolase**

[9027-60-5]

NA16429

Price On Application

**5'-O-Acetylgemcitabine**

see 5'-O-Acetyl-2'-deoxy-2',2'-difluorocytidine, NA10690 on page 14

**5'-O-Acetyl-2',3'-O-isopropylideneadenosine**[15888-38-7] C<sub>15</sub>H<sub>19</sub>N<sub>5</sub>O<sub>5</sub> 349.34

NA04029

1g	\$78.80
2g	\$147.00
5g	\$341.30

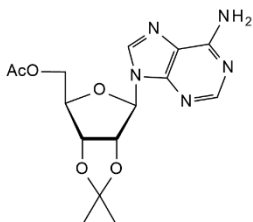

Refs: Yamanori K, Ito R, Yamamoto S, et al, Dalton Trans. 2003, p380

**N2-Acetyl-6-[2-(4-nitrophenyl)ethoxy]-2'-O-trifluoromethanesulfonyl-3',5'-di-O-tritylguanosine**

NA34795

100mg	\$6000.00
-------	-----------



## Acetylpyridi

## 3-Acetylpyridine adenine dinucleotide, reduced form, sodium salt

• APADH

[102029-93-6] C<sub>22</sub>H<sub>28</sub>N<sub>6</sub>O<sub>14</sub>P<sub>2</sub>Na<sub>2</sub> 708.42

NA30684	25mg	\$150.00
	50mg	\$250.00
	100mg	\$400.00



## 3-Acetylpyridine adenine dinucleotide

• APAD

[86-08-8] C<sub>22</sub>H<sub>28</sub>N<sub>6</sub>O<sub>14</sub>P<sub>2</sub> 662.44

NA30683	10mg	\$50.00
	25mg	\$85.00
	50mg	\$150.00



## N-Acetyl-3',5'-O-(1,1,3,3-tetraisopropyl-1,3-disiloxanediyl)adenosine

[828247-65-0] C<sub>23</sub>H<sub>41</sub>N<sub>5</sub>O<sub>7</sub>Si<sub>2</sub> 527.76

NT57554	500mg	\$200.00
	1g	\$300.00
	2g	\$440.00



## N-Acetyl-3',5'-O-(1,1,3,3-tetraisopropyl-1,3-disiloxanediyl)cytidine

[85335-73-5] C<sub>23</sub>H<sub>41</sub>N<sub>5</sub>O<sub>7</sub>Si<sub>2</sub> 527.76

NT57555	500mg	\$200.00
	1g	\$300.00
	2g	\$440.00



## N4-Acetyl-3',5'-O-(1,1,3,3-tetraisopropyl-1,3-disiloxanediyl)cytidine

- 3',5'-O-TIPPS-N4-acetylcytidine
- N4-Acetyl-3',5'-O-TIPPS-cytidine

C<sub>23</sub>H<sub>41</sub>N<sub>5</sub>O<sub>7</sub>Si<sub>2</sub> 527.76

NA09329

Price On Application

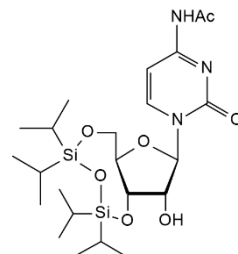

## 3'-O-Acetylthymidine

[21090-30-2] C<sub>12</sub>H<sub>16</sub>N<sub>2</sub>O<sub>6</sub> 284.27

NA08376	500mg	\$95.00
	1g	\$175.00
	2g	\$300.00

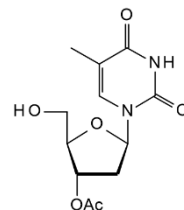

Refs: Schouten A, Kanters JA, Acta Cryst, 1991, C47, p1320



## N4-Acetyl-3',5'-O-TIPPS-cytidine

see N4-Acetyl-3',5'-O-(1,1,3,3-tetraisopropyl-1,3-disiloxanediyl)cytidine, NA09329 on page 20

## N6-Acetyl-2',3',5'-tri-O-acetyl-8-hydroxyadenosine

C<sub>18</sub>H<sub>21</sub>N<sub>5</sub>O<sub>9</sub> 451.39

NA08462	50mg	\$52.50
	100mg	\$95.00
	250mg	\$157.50

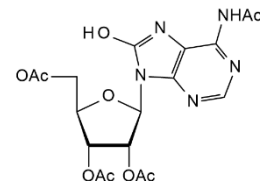



**N4-Acetyl-5'-O-Tritylcytidine**C<sub>30</sub>H<sub>29</sub>N<sub>5</sub>O<sub>5</sub> 511.57

NA57526

Price On Application

**Adenine-9,3-deoxy-b-D-erythro-pentofuranoside**

see 3'-Deoxyadenosine, ND02930 on page 173

**Adenine-riboflavine dinucleotide**

see Riboflavin 5'-adenosine diphosphate disodium salt hydrate, NR35410 on page 350

**Adenosine 3',5'-bisphosphate triethylammonium salt - 10mM aqueous solution**

• Adenosine 3',5'-diphosphate triethylammonium salt

[1053-73-2] C<sub>10</sub>H<sub>15</sub>N<sub>5</sub>O<sub>10</sub>P<sub>2</sub>·X(C<sub>6</sub>H<sub>15</sub>N) 427.20 (free acid basis)

NA44795

500ug	\$325.00
1mg	\$495.00
2mg	\$750.00

**(S)-Adenosine 3',5'-cyclic hydrogenphosphorothioate triethylammonium salt**

see Adenosine 3',5'-cyclic monophosphothioate Sp-isomer sodium salt, NA08994 on page 22

**Adenosine 2',3'-cyclic monophosphate-5'-monophosphate**

NA146212

Price On Application

**Adenosine 2',3'-cyclic monophosphate sodium salt**[37063-35-7] C<sub>10</sub>H<sub>11</sub>N<sub>5</sub>NaO<sub>6</sub>P 351.19

NA07178

50mg	\$80.00
100mg	\$130.00
250mg	\$275.00

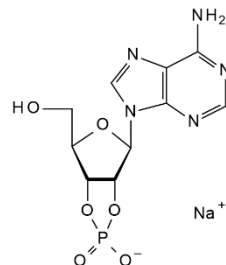
**Adenosine 3',5'-cyclic monophosphate sodium salt**

• cAMP sodium salt

[37839-81-9] C<sub>10</sub>H<sub>11</sub>N<sub>5</sub>NaO<sub>6</sub>P 351.19

NA08992

1g	\$47.30
2g	\$70.00
5g	\$125.00

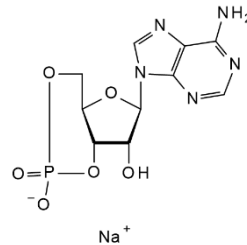
**Adenosine 2',3'-cyclic monophosphate triethylammonium salt**[634-01-5] C<sub>16</sub>H<sub>27</sub>N<sub>6</sub>O<sub>6</sub>P 430.4

NA10355

1mg	\$75.00
2mg	\$120.00
5mg	\$250.00

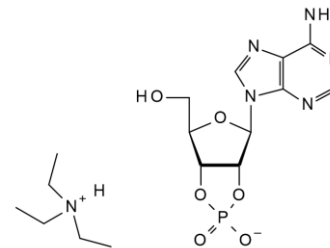

Refs: Blondal T, et al, J. Biol. Chem, 2005, 280, p5188; Shenoy A, et al, J. Mol. Biol, 2007, 365, p211

## Adenosinecyc

## Adenosine 3',5'-cyclic monophosphate

- Cyclic AMP
- cAMP

[60-92-4] C<sub>10</sub>H<sub>12</sub>N<sub>5</sub>O<sub>6</sub>P 329.21

NA08991	1g	\$60.00
	2g	\$100.00
	5g	\$150.00

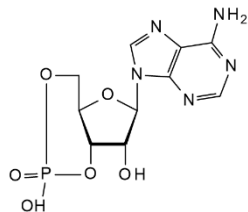

Refs: Eron L, Arditti R, Zubay G, Connaway S, Beckwith JR, Proc Natl Acad Sci U S A. 1971,68, p21

## Adenosine 3',5'-cyclic monophosphorothioate Sp-isomer triethylammonium salt

- cAMPS. TEA, Sp-isomer
- Sp-cAMPS. TEA

[93602-66-5] C<sub>10</sub>H<sub>11</sub>N<sub>5</sub>O<sub>5</sub>PS·C<sub>6</sub>H<sub>16</sub>N 446.46

NA08995	1mg	\$195.00
	2mg	\$300.00
	5mg	\$450.00

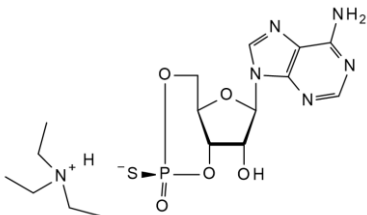

## Adenosine 3',5'-cyclic monophosphorothioate Rp-isomer sodium salt

[73208-40-9] C<sub>10</sub>H<sub>11</sub>N<sub>5</sub>O<sub>5</sub>PS·Na 367.25

NA58197	1mg	\$250.00
	2mg	\$390.00
	5mg	\$875.00



## Adenosine 3',5'-cyclic monophosphorothioate Rp-isomer triethylammonium salt

- cAMP TEA, Rp isomer
- Rp-Cyclic 3',5'-hydrogen phosphorothioate adenosine triethylammonium salt
- Rp-Adenosine 3',5'-cyclic monophosphorothioate triethylammonium salt hydrate

[151837-09-1] C<sub>10</sub>H<sub>11</sub>N<sub>5</sub>O<sub>5</sub>PS·C<sub>6</sub>H<sub>16</sub>N 446.46

NA08993	1mg	\$150.00
	2mg	\$260.00
	5mg	\$600.00

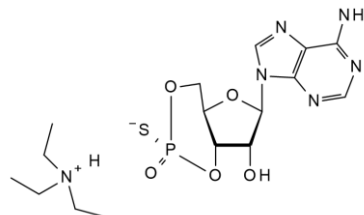

## Adenosine 3',5'-cyclic monophosphorothioate Sp-isomer sodium salt

- (S)-Adenosine 3',5'-cyclic hydrogenphosphorothioate triethylammonium salt
- Sp-cAMPS

[71774-13-5] C<sub>10</sub>H<sub>11</sub>N<sub>5</sub>O<sub>5</sub>PS·Na 367.25

NA08994	1mg	\$150.00
	2mg	\$250.00
	5mg	\$450.00

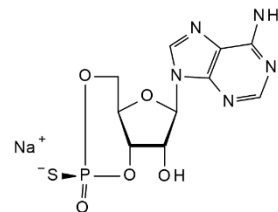

## Adenosine 5'-difluoromethylene-5'-triphosphate triethylammonium salt

NA31345

Price On Application



**Adenosine 3',5'-diphosphate barium salt**[40436-88-2] C<sub>10</sub>H<sub>13</sub>N<sub>5</sub>O<sub>10</sub>P<sub>2</sub>Ba 562.51

Price On Application

NA57558

**Adenosine 5'-diphosphate bis(cyclohexylammonium) salt**[102029-87-8] C<sub>10</sub>H<sub>15</sub>N<sub>5</sub>O<sub>10</sub>P<sub>2</sub>·2C<sub>6</sub>H<sub>13</sub>N 625.55

NA45874

1g	\$50.00
2g	\$90.00
5g	\$200.00

**Adenosine 3',5'-diphosphate disodium salt**

- 3'-Phosphoadenosine 5'-phosphate
- PAP

[75431-54-8] C<sub>10</sub>H<sub>13</sub>N<sub>5</sub>O<sub>10</sub>P<sub>2</sub>·2Na 473.18

NA15774

1mg	\$65.00
2mg	\$100.00
5mg	\$150.00

**Adenosine 5'-diphosphate disodium salt**

- 5'-ADP·2Na·2H<sub>2</sub>O Adenosine-5'-diphosphoric acid disodium salt dihydrate

[16178-48-6] C<sub>10</sub>H<sub>13</sub>N<sub>5</sub>O<sub>10</sub>P<sub>2</sub>·2Na 471.16

NA10195

5g	\$70.00
10g	\$120.00
25g	\$240.00

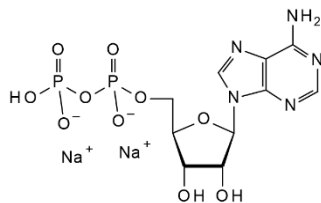
**Adenosine 5'-diphosphate magnesium salt**

- ADP magnesium salt

[20310-60-5]

NA44287

Price On Application

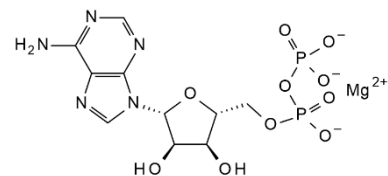
**Adenosine 5'-diphosphate monosodium salt**[20398-34-9] C<sub>10</sub>H<sub>14</sub>N<sub>5</sub>NaO<sub>10</sub>P<sub>2</sub> 449.18

NA08996

10g	\$75.00
25g	\$140.00
50g	\$250.00

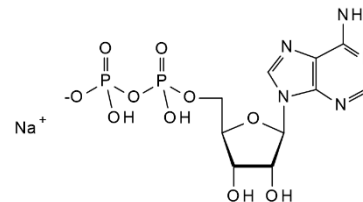
**Adenosine 5'-diphosphate potassium salt**

- ADP.K

[72696-48-1] C<sub>10</sub>H<sub>14</sub>N<sub>5</sub>O<sub>10</sub>P<sub>2</sub>·K 465.29

NA10696

5g	\$68.30
10g	\$99.80
25g	\$184.00

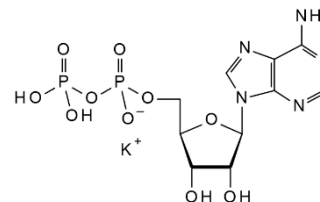
**Adenosine 3',5'-diphosphate triethylammonium salt**

see Adenosine 3',5'-bisphosphate triethylammonium salt - 10mM aqueous solution, NA44795 on page 21

**Adenosinedip****Adenosine 5'-diphosphate trilitium salt**

• ADP.3Li

[31008-64-7]	C <sub>10</sub> H <sub>12</sub> N <sub>5</sub> O <sub>10</sub> P <sub>2</sub> ·Li <sub>3</sub>	445	25g	\$375.00
NA06911			50g	\$550.00
			100g	\$820.00

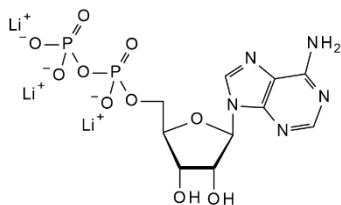
**Adenosine 5'-diphosphate**

• 5'-ADP

[58-64-0]	C <sub>10</sub> H <sub>15</sub> N <sub>5</sub> O <sub>10</sub> P <sub>2</sub>	427.2	5g	\$60.00
NA10698			10g	\$95.00
			25g	\$162.50

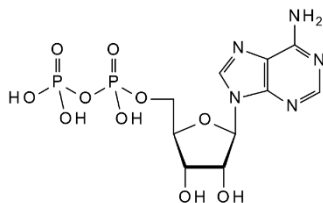
**Adenosine 5'-Diphosphate-13C5**

[58-64-0]	C <sub>513</sub> C <sub>5</sub> H <sub>15</sub> N <sub>5</sub> O <sub>10</sub> P <sub>2</sub>	6528.64	10mg	\$3120.00
NA63511				

**Adenosine-5'-O-diphospho-(1''-(4-nitrophenoxy)-ribose)**

• ADPR-pNP

[939028-75-8]	C <sub>21</sub> H <sub>26</sub> N <sub>6</sub> O <sub>16</sub> P <sub>2</sub>	680.41	Price On Application	
NA63574				

**Adenosine-5'-O-diphosphoribose phosphate**

• ADPRP

[53595-18-9]	C <sub>15</sub> H <sub>24</sub> N <sub>5</sub> O <sub>17</sub> P <sub>3</sub>	639.3	Price On Application	
NA63573				

**Adenosine HCl**[58056-57-8] C<sub>10</sub>H<sub>13</sub>N<sub>5</sub>O<sub>4</sub>·HCl 303.7

NA05656	Price On Application			
---------	----------------------	--	--	--



Refs: Shikata K, Ueki T, Mitsui T, Structural Crystallography and Crystal Chemistry, 1973, B29, p31

**Adenosine 5'-monophosphate disodium salt**

[4578-31-8][13474-03-6]	C <sub>10</sub> H <sub>12</sub> N <sub>5</sub> O <sub>7</sub> P·2Na	391.19	100g	\$65.00
NA03463			250g	\$125.00
			500g	\$200.00

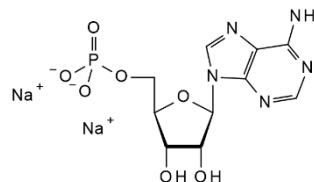
**Adenosine 5'-monophosphate monohydrate**• 5'-AMP·H<sub>2</sub>O Adenosine-5'-monophosphoric acid monohydrate 5'-Adenylic acid

[18422-05-4]	C <sub>10</sub> H <sub>14</sub> N <sub>5</sub> O <sub>7</sub> P·H <sub>2</sub> O	365.24	25g	\$39.50
NA30567			50g	\$66.00
			100g	\$105.00



## Adenosine 3'-monophosphate sodium salt

[4958-39-8]

NA10682

50mg	\$63.00
100mg	\$105.00
250mg	\$157.50



## Adenosine 5'-monophosphate sodium salt

[13474-03-8][149022-20-8]

C<sub>10</sub>H<sub>13</sub>N<sub>5</sub>O<sub>7</sub>P·Na 369.2

NA10369

50g	\$75.00
100g	\$120.00
250g	\$220.00

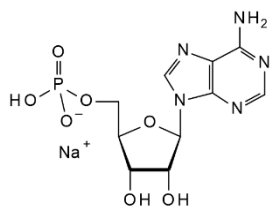

## Adenosine 5'-monophosphate sodium salt [1',2',3',4',5'-13C5]

NA57597

10mg \$1800.00



## Adenosine 5'-monophosphate [U-13C10,U-15N5]

NA31536

Price On Application



## Adenosine-2'-monophosphate

• Adenosine 2'-monophosphoric acid

[81012-86-4] C<sub>10</sub>H<sub>14</sub>N<sub>5</sub>O<sub>7</sub>P 347.22

NA57349

25mg	\$90.00
50mg	\$150.00
100mg	\$250.00



## Adenosine-3'-monophosphate

• 3'-AMP  
• 3'-Adenylic acid[84-21-9] C<sub>10</sub>H<sub>14</sub>N<sub>5</sub>O<sub>7</sub>P 347.22

NA66252

100mg	\$95.00
250mg	\$150.00
500mg	\$250.00



## Adenosine 5'-monophosphate

[61-19-8] C<sub>10</sub>H<sub>14</sub>N<sub>5</sub>O<sub>7</sub>P 347.22

NA06318

100g	\$55.00
250g	\$115.00
500g	\$195.00

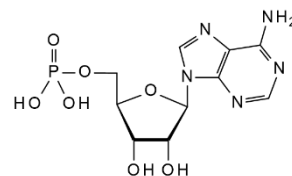

## L-Adenosine 5'-monophosphate

NA10801

Price On Application



## Adenosine 2'-monophosphoric acid

see Adenosine-2'-monophosphate, NA57349 on page 25

## Adenosinephe

## Adenosine 2',3'-O-phenylboronate

[4710-68-3] C<sub>16</sub>H<sub>16</sub>BN<sub>5</sub>O<sub>4</sub> 353.14

NA07179

100mg	\$90.00
250mg	\$185.00
500mg	\$370.00

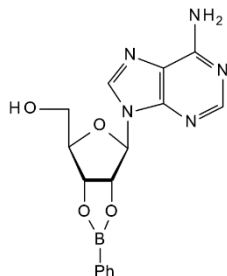

## Adenosine 3'-phosphate 5'-phosphosulfate lithium salt hydrate

see 3'-Phosphoadenosine-5'-phosphosulfate lithium salt hydrate, NP46144 on page 340

## Adenosine 2(3')-phosphate 5'-phosphosulfate lithium salt

see 2'-Phosphoadenosine 5'-phosphosulfate tetralithium salt (mixture with 3'-isomer), NP46146 on page 341

## Adenosine-5'-[(propargyl)]triphosphate sodium salt

C<sub>13</sub>H<sub>16</sub>N<sub>5</sub>O<sub>13</sub>P<sub>3</sub> 545.23

NA30542

Price On Application

Adenosine, 5'-(tetrahydrogen triphosphate), P<sup>3-</sup>-(1-(2-nitrophenyl)ethyl) ester, disodium salt

see P3-(1-(2-Nitrophenyl)ethyl) adenosine 5'-triphosphate disodium salt, NN63886 on page 336

## Adenosine 5'-O-(3-thiotriphosphate), BODIPY FL thioester sodium salt - 5mM buffered aqueous solution

• BODIPY FL ATP-gamma-S thioester

C<sub>24</sub>H<sub>27</sub>BF<sub>2</sub>N<sub>6</sub>Na<sub>3</sub>O<sub>13</sub>P<sub>3</sub>S 878.28

NA58152

1pack

\$795.00



## Adenosine-5'-O-(1-thiotriphosphate) lithium salt - 100 mM aqueous solution

• α-Thio-ATP

[35094-46-3] C<sub>10</sub>H<sub>16</sub>N<sub>5</sub>O<sub>12</sub>P<sub>3</sub>S·4Li 551.01

NA58205

500ug	\$50.00
1mg	\$90.00
2mg	\$170.00



## Adenosine 5'-triphosphate disodium salt hydrate

[34369-07-8] C<sub>10</sub>H<sub>14</sub>N<sub>5</sub>Na<sub>2</sub>O<sub>13</sub>P<sub>3</sub> 551.14

NA00135

100g	\$65.00
250g	\$125.00
500g	\$225.00

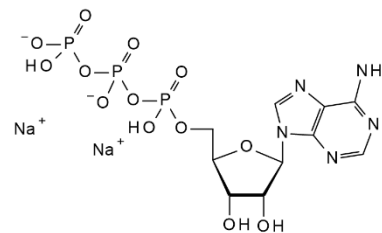

Refs: Beilstein Beil. 26,IV, p3654

## Adenosine 5'-triphosphate magnesium salt

• ATP magnesium salt

[74804-12-9] C<sub>10</sub>H<sub>14</sub>MgN<sub>5</sub>O<sub>13</sub>P<sub>3</sub> 529.47

NA44288

500mg	\$85.00
1g	\$120.00
2g	\$175.00

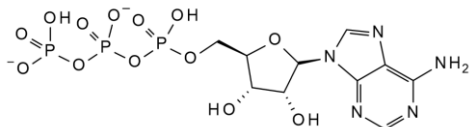
Mg<sup>2+</sup>

## L-Adenosine 5'-triphosphate sodium salt

C<sub>10</sub>H<sub>12</sub>N<sub>5</sub>O<sub>13</sub>P<sub>3</sub>Na<sub>4</sub> 595.11

NA63217

Price On Application

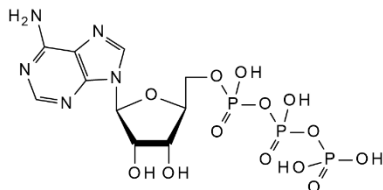

## Adenosine 5'-triphosphate trisodium salt

[20978-32-9] C<sub>10</sub>H<sub>15</sub>N<sub>5</sub>O<sub>13</sub>P<sub>3</sub>Na<sub>3</sub> 575.14

NA02978

Price On Application



## Adenosine

[58-61-7] C<sub>10</sub>H<sub>13</sub>N<sub>5</sub>O<sub>4</sub> 267.25

NA01639

250g	\$62.50
500g	\$100.00
1kg	\$175.00

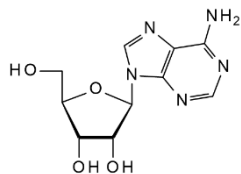

Refs: Moser GH, Schrader J, Deussen A, Am. J. Physiol. 1989, 256, pC799

## Adenosine - Endotoxin level below 100 EU/g

[58-61-7] C<sub>10</sub>H<sub>13</sub>N<sub>5</sub>O<sub>4</sub> 267.24

NA106350

100g	\$38.00
250g	\$85.00
500g	\$140.00



## Adenosine - Endotoxin level below 1000 EU/g

[58-61-7] C<sub>10</sub>H<sub>13</sub>N<sub>5</sub>O<sub>4</sub> 267.24

NA31619

100g	\$50.00
250g	\$110.00
500g	\$195.00



## L-Adenosine

• 9-(b-L-Ribofuranosyl)adenine

[3080-29-3] C<sub>10</sub>H<sub>13</sub>N<sub>5</sub>O<sub>4</sub> 267.24

NA06227

50mg	\$95.00
100mg	\$175.00
250mg	\$325.00

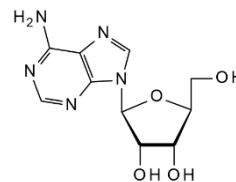

Refs: Klusmann S, Nolte A, Bald R, et al, Nature Biotech. 1996, 14, 9, p1112



**Adenosylhomo****S-(5'-Adenosyl)-L-homocysteine dihydrate**

- S-(5'-Deoxyadenosin-5'-yl)-L-homocysteine
- L-5'-S-(3-Amino-3-carboxypropyl)-5'-thioadenosine
- Adenosyl-L-homocysteine

[979-92-0] C<sub>14</sub>H<sub>20</sub>N<sub>6</sub>O<sub>5</sub>S·2H<sub>2</sub>O 420.44

NA17223

10mg	\$75.00
25 mg	\$125.00
50 mg	\$210.00

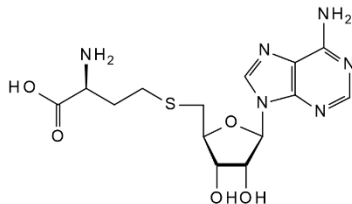

Refs: Chamberlin, M. et al, J. Clin. Invest, 98, 1021

**Adenosyl-L-homocysteine**see *S-(5'-Adenosyl)-L-homocysteine dihydrate*, NA17223 on page 28**S-Adenosylmethione-1,4-butanedisulfonate**[101020-79-5] C<sub>42</sub>H<sub>74</sub>N<sub>12</sub>O<sub>28</sub>S<sub>8</sub> 1451.63

NA58198

2g	\$50.00
5g	\$90.00
10g	\$120.00

**S-(5'-Adenosyl)-L-methionine chloride dihydrochloride**

- SAM chloride dihydrochloride

[24346-00-7][86867-01-8] C<sub>15</sub>H<sub>23</sub>Cl<sub>2</sub>N<sub>6</sub>O<sub>5</sub>S·2HCl 507.82

NA29499

25mg	\$75.00
50mg	\$140.00
100mg	\$225.00

**S-Adenosyl-L-methionine disulfate tosylate**[97540-22-2] C<sub>15</sub>H<sub>22</sub>N<sub>6</sub>O<sub>5</sub>S·C<sub>7</sub>H<sub>12</sub>O<sub>11</sub>S<sub>2</sub> 766.8

NA08266

100g	\$60.00
250g	\$145.00
500g	\$280.00

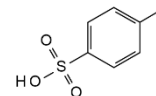
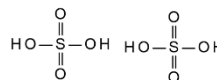
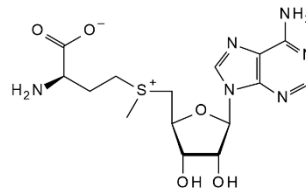

Refs: Yang J, et al, Clinical Therapeutics, 2009, 31, 2, p311

**S-Adenosyl-L-methionine p-toluenesulfonate**

- (3S)-5'-[(3-Amino-3-carboxylatopropyl)methylsulphonio]-5'-deoxyadenosine)
- SAMe p-toluenesulfonate
- S-Adenosylmethionine Tosylate

[86562-85-8][17176-17-9][71914-80-2] C<sub>15</sub>H<sub>22</sub>N<sub>6</sub>O<sub>5</sub>S·C<sub>7</sub>H<sub>7</sub>O<sub>3</sub>S 570.64

NA04017

10g	\$65.00
25g	\$125.00
50g	\$190.00

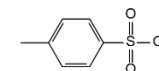
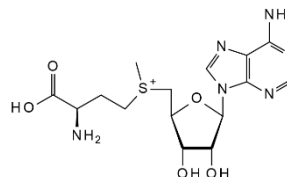

Refs: Chiang PK, Gordon RK, Tal J, et al, Faseb J. 1996, 10, 4, p471

**S-Adenosylmethionine Tosylate**see *S-Adenosyl-L-methionine p-toluenesulfonate*, NA04017 on page 28



**S-Adenosyl-L-methionine**[29908-03-0] C<sub>15</sub>H<sub>22</sub>N<sub>6</sub>O<sub>5</sub>S 398.44

NA16291

250mg	\$55.00
500mg	\$85.00
1g	\$135.00

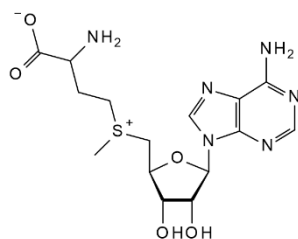
**P1-(5'-Adenosyl) P3-(5'-adenosyl) triphosphate sodium salt**

• AP3A

[5959-90-0] C<sub>20</sub>H<sub>27</sub>N<sub>10</sub>O<sub>16</sub>P<sub>3</sub> 756.41

NA46695

1mg	\$375.00
2mg	\$550.00
5mg	\$1125.00

**5'-Adenylic acid monoanhydride with (dichlorophosphonomethyl)phosphonic acid**[81336-74-5] C<sub>11</sub>H<sub>16</sub>Cl<sub>2</sub>N<sub>6</sub>O<sub>12</sub>P<sub>3</sub> 574.1

NA10201

Price On Application

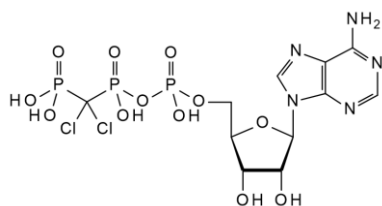
**3'-Adenylic acid**

see Adenosine-3'-monophosphate, NA66252 on page 25

**Adenylyl-3'-5'-adenosine ammonium salt**[2392-46-0][102029-96-9] C<sub>20</sub>H<sub>25</sub>N<sub>10</sub>O<sub>10</sub>P 596.45

NA05778

Price On Application



Refs: Tazawa I, Tazawa S, Stempel LM, Ts'O P, Biochemistry, 1970, 9,18, p3499

**Adenylyl-3'-5'-cytidine**[2382-66-3] C<sub>19</sub>H<sub>25</sub>N<sub>6</sub>O<sub>11</sub>P 572.42

NA07946

500ug	\$160.00
1mg	\$262.50
2mg	\$409.50

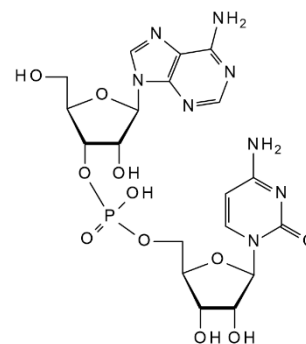

Refs: Kazuo T, Yukihide U, Yoichi I, Yukio M, , Nucleic Acids Res, 1978, 1, p403

**Adenylyl-3'-5'-guanosine ammonium salt**[3352-23-6][10202-53-8] C<sub>20</sub>H<sub>25</sub>N<sub>10</sub>O<sub>11</sub>P 612.45

NA46044

1mg	\$475.00
2mg	\$925.00
5mg	\$1625.00



**ADENYLYLGUAN****ADENYLYL-(3'-5')-GUANOSINE**[102029-53-8] C<sub>20</sub>H<sub>25</sub>N<sub>10</sub>O<sub>11</sub>P·H<sub>3</sub>N 629.48

NA143918

Price On Application

**Adenylyl-3'-5'-uridine ammonium salt**C<sub>19</sub>H<sub>24</sub>N<sub>7</sub>O<sub>12</sub>P 573.41

NA46045

1mg	\$475.00
2mg	\$925.00
5mg	\$1625.00

**ADP-cyclo[N1:1'']-ribose**see *Cyclic adenosine 5'-diphosphate ribose ammonium salt, NC11582 on page 156***ADP.K**see *Adenosine 5'-diphosphate potassium salt, NA10696 on page 23***ADP.3Li**see *Adenosine 5'-diphosphate trillithium salt, NA06911 on page 24***ADP magnesium salt**see *Adenosine 5'-diphosphate magnesium salt, NA44287 on page 23***5'-ADP·2Na·2H<sub>2</sub>O Adenosine-5'-diphosphoric acid disodium salt dihydrate**see *Adenosine 5'-diphosphate disodium salt, NA10195 on page 23***ADPR-pNP**see *Adenosine-5'-O-diphospho-(1''-(4-nitrophenoxy)-ribose), NA63574 on page 24***ADPRP**see *Adenosine-5'-O-diphosphoribose phosphate, NA63573 on page 24***5'-ADP**see *Adenosine 5'-diphosphate, NA10698 on page 24***8-AEA-cAMP**see *8-(2-Aminoethyl)aminoadenosine 3',5'-cyclic monophosphate, NA09017 on page 53***AFB-guanine**

• (6aS,8R,9R,9aR)-8-(2-Amino-1,6-dihydro-6-oxo-7H-purin-7-yl)-2,3,6a,8,9,9a-hexahydro-9-hydroxy-4-methoxy-cyclopenta[c]furo[3',2':4,5]furo[2,3-h][1]benzopyran-1,11-dione

[63425-04-7] C<sub>22</sub>H<sub>17</sub>N<sub>5</sub>O<sub>8</sub> 479.4

NA17231

1mg	\$1754.90
2mg	\$3190.70
5mg	\$5801.30

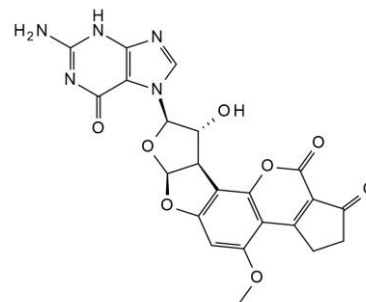

Refs: Alvarez, M, et al, Nat. Tox, 7, 139 (1999); Ross, M, et al, Tox. Sci, 53, 224 (2000); Sotomayor, R, et al, Toxicol. Sci, 73, 329 (2003)

**AICAR 3',5'-cyclic phosphate**

- 5-Aminoimidazole-4-carboxamide-1-β-D-ribofuranosyl 3':5'-cyclic-monophosphate
- 5-Amino-1-(3,5-O-phosphinico-β-D-ribofuranosyl)-1H-imidazole-4-carboxamide
- NSC 371796

[35908-14-6] C<sub>8</sub>H<sub>13</sub>N<sub>4</sub>O<sub>7</sub>P 320.2

NA16501

2mg	\$110.00
5mg	\$225.00
10mg	\$390.00

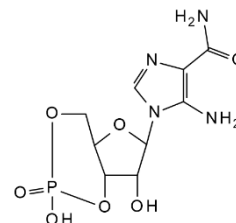

Refs: Fujii, T, et al, Chem. Pharm. Bull, 19, 1368 (1971); Montgomery, J.A, et al, J. Med. Chem, 15, 182 (1972)

**AICAR monophosphate**see *5-Aminoimidazole-4-carboxamide-1-β-D-ribofuranose 5'-monophosphate, NA07204 on page 56***AICAR Triphosphate**see *5-Aminoimidazole-4-carboxamide-1-β-D-ribofuranosyl 5'-triphosphate, NA01454 on page 57*

## AICAR

see 5-Aminoimidazole-4-carboxamide-1- $\beta$ -D-ribofuranose, NA03552 on page 56

## Allopurinol riboside

• 1- $\beta$ -D-Ribofuranosyl-1H-pyrazolo[3,4-d]pyrimidine-4-one[16220-07-8] C<sub>10</sub>H<sub>12</sub>N<sub>4</sub>O<sub>5</sub> 268.23

NA07960

25mg	\$125.00
50mg	\$225.00
100mg	\$400.00

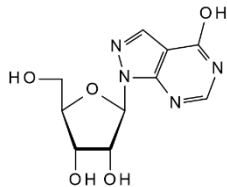

Refs: Nishida Y, Kamatani N, Tanimoto K, Akaoka I, Inflammation Research 1979, 9, 5-6, p549

## Alloxan tetrahydrate

• Mesoxalylurea

• 5,6-Dioxyuracil; 2,4,5,6-Tetraoxypyrimidine

[6010-91-9] C<sub>4</sub>H<sub>10</sub>N<sub>2</sub>O<sub>8</sub> 214.13

NA71089

10g	\$45.00
25g	\$100.00
50g	\$150.00



## 2'-O-Allyladenosine

C<sub>13</sub>H<sub>17</sub>N<sub>5</sub>O<sub>4</sub> 307.31

NA05071

5mg	\$63.00
10mg	\$115.50
25mg	\$210.00

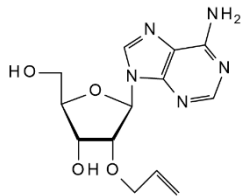

Refs: Rozners E, Curr. Org. Chem. 2006, 10, 6, p675

## 3'-O-Allyladenosine

C<sub>13</sub>H<sub>17</sub>N<sub>5</sub>O<sub>4</sub> 307.31

NA06237

5mg	\$63.00
10mg	\$115.50
25mg	\$210.00

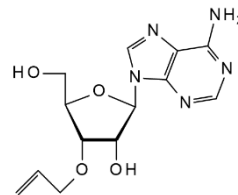

## 2'-O-Allylcytidine

C<sub>12</sub>H<sub>17</sub>N<sub>3</sub>O<sub>5</sub> 283.28

NA06245

5mg	\$75.00
10mg	\$90.00
25mg	\$150.00

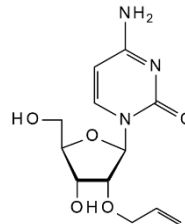

Refs: Flanagan WM, Su LL, Wagner RW, Nature Biotechnol. 1996, 14, 9, p1139

## 3'-O-Allylcytidine

C<sub>12</sub>H<sub>17</sub>N<sub>3</sub>O<sub>5</sub> 283.28

NA05280

5mg	\$63.00
10mg	\$105.00
25mg	\$210.00

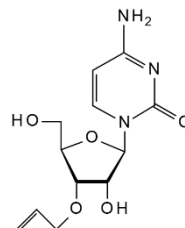

## Allyldihydro

## 7-Allyl-7,8-dihydro-8-oxoguanosine

- Loxoribine
- 7,8-Dihydro-8-oxo-7-(2-propenyl)guanosine

[121288-39-9] C<sub>13</sub>H<sub>17</sub>N<sub>5</sub>O<sub>6</sub> 339.3

NA07175	10mg	\$94.50
	25mg	\$189.00
	50mg	\$346.50

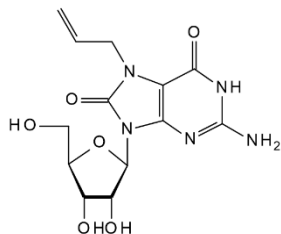

Refs: Come J, et.al, Tetrahydron Lett, 1991, 32, p4823; Reitz AB, et.al, J. Med Chem. 1994, 37, p3761

## 2'-O-Allylguanosine

C<sub>13</sub>H<sub>17</sub>N<sub>5</sub>O<sub>5</sub> 323.3

NA06238	5mg	\$73.50
	10mg	\$115.50
	25mg	\$189.00

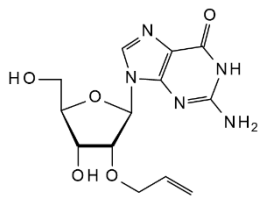

Refs: Grotti M, Douglas M, Beijer B, et al, Bioorg. Med. Chem. Lett. 1997, 7, 4, p425

## 3'-O-Allylguanosine

C<sub>13</sub>H<sub>17</sub>N<sub>5</sub>O<sub>5</sub> 323.3

NA06243	2mg	\$50.00
	5mg	\$90.00
	10mg	\$140.00

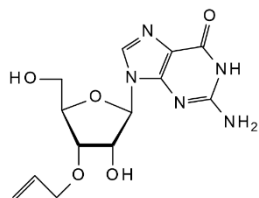

## 8-(Allyloxy)guanosine

- 8-(2-Propenylloxy)guanosine

[126138-81-6] C<sub>13</sub>H<sub>17</sub>N<sub>5</sub>O<sub>6</sub> 339.3

NA16502	10mg	\$60.00
	25mg	\$100.00
	50mg	\$160.00

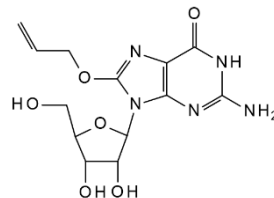

Refs: Reitz, A.B, et al, J. Med. Chem, 37, 3561 (1994)



## 2'-O-Allyluridine

C<sub>12</sub>H<sub>16</sub>N<sub>2</sub>O<sub>6</sub> 284.27

NA06678	5mg	\$63.00
	10mg	\$105.00
	25mg	\$210.00

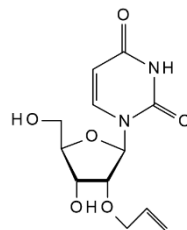

Refs: Rozners E, Curr. Org. Chem. 2006, 10, 6, p675



## 3'-O-Allyluridine

C<sub>12</sub>H<sub>16</sub>N<sub>2</sub>O<sub>6</sub> 284.27

NA06249	5mg	\$63.00
	10mg	\$105.00
	25mg	\$210.00

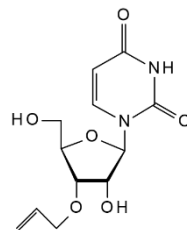

Refs: Toulmè JJ, Nucleic Acids Research, 1995, 23, p64



## Alovudine

see 3'-Deoxy-3'-fluorothymidine, ND02399 on page 202

## ALS-8176

• 4'-Chloromethyl-2'-deoxy-3',5'-di-O-isobutyryl-2'-fluorocytidine

NA63420

Price On Application



## 8-Aminoadenosine-5'-triphosphate lithium salt - 100mM aqueous solution

• 8-Amino-ATP

[35874-49-8 (free acid)] C<sub>10</sub>H<sub>17</sub>N<sub>6</sub>O<sub>13</sub>P<sub>3</sub> 522.2

NA32071

0.5mg	\$140.00
2.5mg	\$475.00
5mg	\$750.00

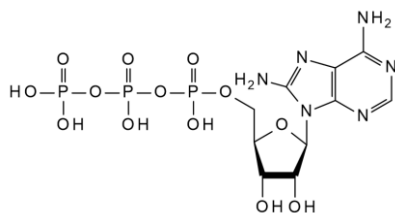

## 8-Aminoadenosine-5'-triphosphate sodium salt - 10mM aqueous solution

[35874-49-8] C<sub>10</sub>H<sub>17</sub>N<sub>6</sub>O<sub>13</sub>P<sub>3</sub> 522.2

NA12011

1mg	\$210.00
2mg	\$315.00
5mg	\$656.30

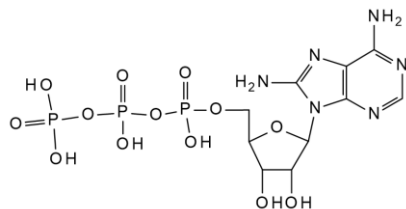

## 2'-Amino-D-adenosine

see 2'-Amino-2'-deoxyadenosine, NA02636 on page 45

## 2-Aminoadenosine

• 2,6-Diaminopurine riboside

[2096-10-8] C<sub>10</sub>H<sub>14</sub>N<sub>6</sub>O<sub>4</sub> 282.26

NA02915

25g	\$52.50
50g	\$89.50
100g	\$158.00

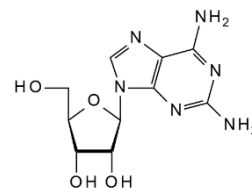

Refs: Lamm GM, Blencowe BJ, Sproat BS, et al. Nucleic Acids Res. 1991, 25, 19(12), p3193-3198

## 3'-Amino-D-adenosine

see 3'-Amino-3'-deoxyadenosine, NA03336 on page 45

## 8-Aminoadenosine

[3868-33-5] C<sub>10</sub>H<sub>14</sub>N<sub>6</sub>O<sub>4</sub> 282.26

NA05711

50mg	\$92.00
100mg	\$158.00
250mg	\$342.50

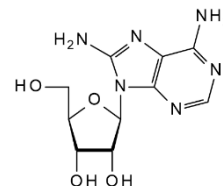

Refs: Sasaki S, Minamoto K, Itoh H, J. Org. Chem. 1978, 43, 12, p2320

## 5-Aminoallylcytidine 5'-triphosphate lithium salt - 100mM aqueous solution

• 5-AA-CTP

C<sub>12</sub>H<sub>21</sub>N<sub>4</sub>O<sub>14</sub>P<sub>3</sub>·xLi 538.23 (free acid basis)

NA32073

0.5mg	\$125.00
2.5mg	\$475.00
5mg	\$800.00

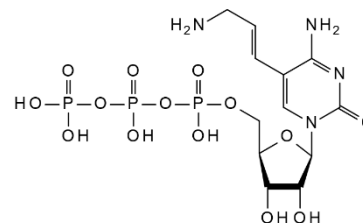

## Aminoallylde

## 5-Aminoallyl 2'-deoxycytidine-5'-triphosphate lithium salt - 100mM aqueous solution

• 5-(3-Aminoallyl)-2'-deoxycytidine-5'-triphosphate, lithium salt

C<sub>12</sub>H<sub>17</sub>N<sub>4</sub>O<sub>13</sub>P<sub>3</sub>·4Li 545.97

NA32075

1mg	\$250.00
2.5mg	\$525.00
5mg	\$850.00

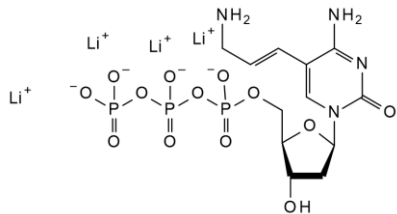

## 5-(3-Aminoallyl)-2'-deoxycytidine-5'-triphosphate, lithium salt

see 5-Aminoallyl 2'-deoxycytidine-5'-triphosphate lithium salt - 100mM aqueous solution, NA32075 on page 34

## 5-Aminoallyl-2'-deoxycytidine

NA02925

Price On Application



## 5-Aminoallyl- 2'-deoxyuridine 5'-triphosphate, labeled with 5/6-TAMRA - 1mM aqueous solution

[151345-35-6] C<sub>37</sub>H<sub>40</sub>N<sub>5</sub>O<sub>18</sub>P<sub>3</sub> 935.66 (free acid)

NT11637

Price On Application

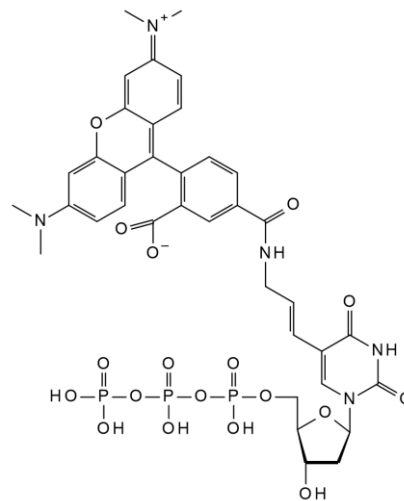

## 5-Aminoallyl 2'-deoxyuridine 5'-triphosphate lithium salt - 100mM aqueous solution

- 5-Aminoallyl-2'-deoxyuridine-5'-triphosphate
- 5-AA-dUTP.Li

[116840-18-7] C<sub>12</sub>H<sub>20</sub>N<sub>3</sub>O<sub>14</sub>P<sub>3</sub> 523.22

NA32074

1mg	\$195.00
2.5mg	\$425.00
5mg	\$675.00

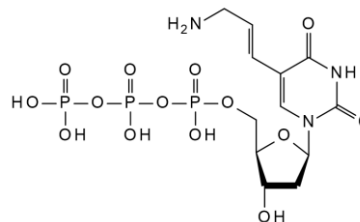

**5-Aminoallyl 2'-deoxyuridine 5'-triphosphate sodium salt - 100mM aqueous solution**

• 5-(3-Aminoallyl)-2'-deoxyuridine-5'-triphosphate sodium salt

[936327-10-5]	$C_{12}H_{20}N_5O_{14}P_3 \cdot xNa$	523.22 (free acid basis)	1mg	\$350.00
NA46883			2mg	\$530.00
			5mg	\$685.00

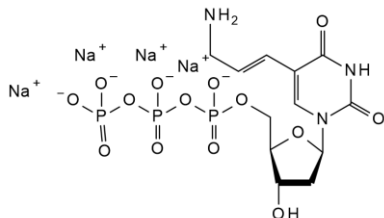
**5-(3-Aminoallyl)-2'-deoxyuridine-5'-triphosphate sodium salt**

see 5-Aminoallyl 2'-deoxyuridine 5'-triphosphate sodium salt - 100mM aqueous solution, NA46883 on page 35

**5-Aminoallyl-2'-deoxyuridine-5'-triphosphate**

see 5-Aminoallyl 2'-deoxyuridine 5'-triphosphate lithium salt - 100mM aqueous solution, NA32074 on page 34

**5-Aminoallyl-2'-deoxyuridine**[87980-17-4]  $C_{12}H_{18}N_4O_4$  282.3

Price On Application

NA02924

**5-Aminoallyl uridine 5'-triphosphate sodium salt**

• 5-(3-Aminoallyl)-uridine-5'-triphosphate sodium salt

[112131-73-4]	$C_{12}H_{20}N_5O_{15}P_3 \cdot xNa$	539.22 (free acid basis)	1mg	\$250.00
NA46887			2mg	\$450.00
			5mg	\$700.00

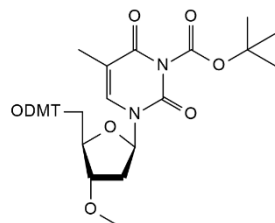
**5-Aminoallyluridine 5'-triphosphate sodium salt - 100mM aqueous solution**

• 5-[3-Aminoallyl]-uridine-5'-triphosphate sodium salt

[112131-73-4]	$C_{12}H_{20}N_5O_{15}P_3 \cdot xNa$	539.22 (free acid basis)	0.5mg	\$125.00
NA32072			2.5mg	\$375.00
			5mg	\$550.00

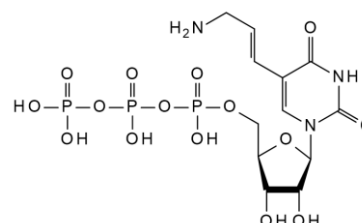
**5-(3-Aminoallyl)-uridine-5'-triphosphate sodium salt**

see 5-Aminoallyl uridine 5'-triphosphate sodium salt, NA46887 on page 35

**5-[3-Aminoallyl]-uridine-5'-triphosphate sodium salt**

see 5-Aminoallyluridine 5'-triphosphate sodium salt - 100mM aqueous solution, NA32072 on page 35

**[(2R,3S,4R,5R)-4-Amino-2-[[[(2R,3S,4R,5R)-4-amino-5-(4-amino-2-oxo-pyrimidin-1-yl)-3-phosphonooxy-oxolan-2-yl]methoxymethyl]-5-(2-amino-6-oxo-3H-purin-9-yl)oxolan-3-yl]oxyphosphonic acid**

see 5'-Phosphoryl-(3'-amino-3'-deoxyguanylyl)-(3'-5')-3'-amino-3'-deoxycytidine, NP28800 on page 341

**5-[[[2-Amino-5-O-(aminocarbonyl)-2-deoxy-L-xylonoyl]amino]-1-(5-carboxy-3,4-dihydro-2,4-dioxo-1(2H)-pyrimidinyl)-1,5-dideoxy-β-D-allofuranuronic acid**

see Polyoxorim, NP157259 on page 342

**2-Amino-3'-amino-2',3'-dideoxyadenosine**

see 3'-Amino-2',3'-dideoxy-2,6-diaminopurine riboside, NA46160 on page 50

## Aminoaminodi

(2S)-2-Amino-6-((4-amino-1-[(2R,3R,4S,5R)-3,4-dihydroxy-5-(hydroxymethyl)oxolan-2-yl]-1,2-dihydropyrimidin-2-ylidene)amino)hexanoic acid

• Lysidine

[144796-96-3] C<sub>15</sub>H<sub>25</sub>N<sub>5</sub>O<sub>6</sub> 371.39

NA46541

5mg \$3512.00  
10mg \$4512.00

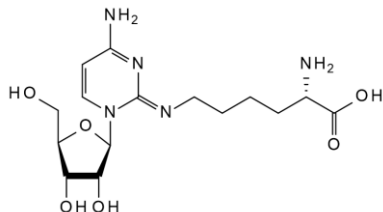

3'-Amino-5'-O-p-anisoyl-N4-benzoyl-2',3'-dideoxycytidine

C<sub>24</sub>H<sub>24</sub>N<sub>4</sub>O<sub>8</sub> 464.47

NA08999

Price On Application

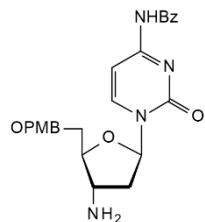

3'-Amino-5'-O-p-anisoyl-3'-deoxy-D3-thymidine

C<sub>18</sub>H<sub>18</sub>N<sub>3</sub>O<sub>7</sub>D<sub>3</sub> 394.39

NA09001

Price On Application

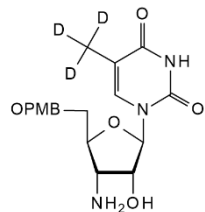

3'-Amino-5'-O-p-anisoyl-3'-deoxythymidine

C<sub>18</sub>H<sub>21</sub>N<sub>3</sub>O<sub>6</sub> 375.38

NA09000

Price On Application

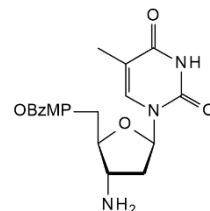

3'-Amino-5'-O-p-anisoyl-2',3'-dideoxyuridine

C<sub>17</sub>H<sub>19</sub>N<sub>3</sub>O<sub>6</sub> 361.35

NA08210

Price On Application

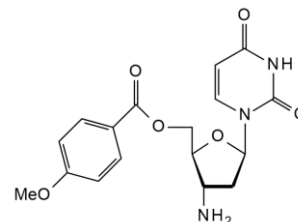

4-Amino-1-(β-D-Arabinofuranosyl)-2(1H)pyrimidinone

see 1-(β-D-Arabinofuranosyl)cytosine, NA05771 on page 73

8-Amino-ATP

see 8-Aminoadenosine-5'-triphosphate lithium salt - 100mM aqueous solution, NA32071 on page 33

3'-Amino-N4-benzoyl-5'-O-benzoyl-2',3'-dideoxyadenosine

C<sub>24</sub>H<sub>22</sub>N<sub>6</sub>O<sub>4</sub> 458.47

NA09002

Price On Application

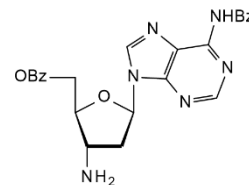



**3'-Amino-N4-benzoyl-5'-O-tert-butylidimethylsilyl-2',3'-dideoxycytidine**C<sub>22</sub>H<sub>32</sub>N<sub>4</sub>O<sub>4</sub>Si 444.6

NA09003

Price On Application

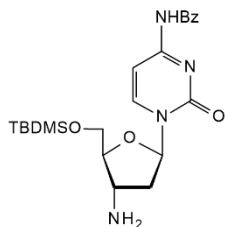
**3'-Amino-N6-benzoyl-2'-O-tert-butylidimethylsilyl-5'-O-DMT-3'-deoxyadenosine**C<sub>44</sub>H<sub>50</sub>N<sub>6</sub>O<sub>6</sub>Si 786.99

NA59527

100mg

\$6000.00

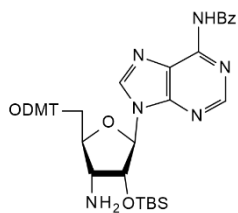
**3'-Amino-5'-O-benzoyl-3'-deoxy-D3-thymidine**C<sub>17</sub>H<sub>16</sub>N<sub>3</sub>O<sub>5</sub>D<sub>3</sub> 348.37

NA09007

Price On Application

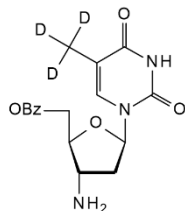
**3'-Amino-N6-benzoyl-2',3'-dideoxy-5'-O-DMT-adenosine**C<sub>38</sub>H<sub>38</sub>N<sub>6</sub>O<sub>5</sub> 656.73

NA08316

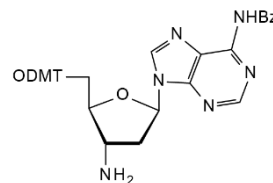
50mg  
100mg  
250mg\$136.50  
\$263.00  
\$577.50**3'-Amino-N4-benzoyl-2',3'-dideoxy-5'-O-DMT-cytidine**C<sub>37</sub>H<sub>38</sub>N<sub>4</sub>O<sub>6</sub> 632.71

NA08780

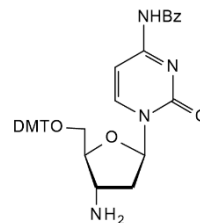
10mg  
25mg  
50mg\$42.00  
\$73.50  
\$126.00**2-Amino-benzoyl-9-(5'-O-DMT-b-D-ribofuranosyl)purine**C<sub>38</sub>H<sub>35</sub>N<sub>5</sub>O<sub>7</sub> 673.71

NB08321

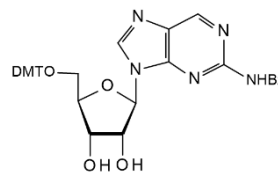
50mg  
100mg  
250mg\$115.50  
\$210.00  
\$420.00

**Aminobenzylid****3'-Amino-5'-O-benzyl-3'-deoxy-D3-thymidine**C<sub>17</sub>H<sub>18</sub>N<sub>3</sub>O<sub>4</sub>D<sub>3</sub> 334.39

NA09009

Price On Application

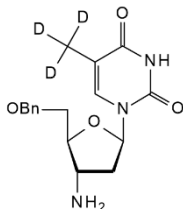
**3'-Amino-5'-O-benzyl-2',3'-dideoxyuridine**C<sub>16</sub>H<sub>19</sub>N<sub>3</sub>O<sub>4</sub> 317.34

NA08215

Price On Application

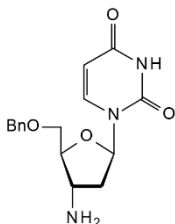
**(1S,2S,3S,5S)-5-(2-Amino-6-(benzyloxy)-9H-purin-9-yl)-3-(benzyloxy)-2-(benzyloxymethyl)cyclopentanol**

• Entecavir Intermediate IV

[142217-77-4] C<sub>32</sub>H<sub>33</sub>N<sub>5</sub>O<sub>4</sub> 551.64

NA32025

500mg	\$60.00
1g	\$100.00
2g	\$160.00

**2-Amino-6-(benzyloxy)-9-b-D-ribofuranosyl-purine**see *O6-Benzyl guanosine*, NB16621 on page 117**4-Amino-3-benzyl-1H-pyrazolo[3,4-d]pyrimidine 1-b-D-ribofuranose**

• 3-(Phenylmethyl)-1-b-D-ribofuranosyl-1H-pyrazolo[3,4-d]pyrimidin-4-amine

[476371-76-3] C<sub>17</sub>H<sub>19</sub>N<sub>5</sub>O<sub>4</sub> 357.36

NA16507

1mg	\$965.20
2mg	\$1754.90
5mg	\$3190.70

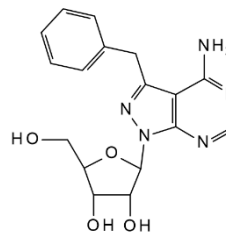

Refs: Hunter, T, et al, Cell, 100, 113 (2000); Habelhah, H, et al, J. Biol. Chem, 276, 18090 (2001); Shah, K, et al, Chem. Biol, 9, 33 (2002)

**4-Amino-3-benzyl-1H-pyrazolo[3,4-d]pyrimidine 1-b-D-ribofuranosyl 5'-triphosphate**

• 1-[5-O-[Hydroxy[[hydroxy(phosphonoxy)phosphinyl]oxy]phosphinyl]-b-D-ribofuranosyl]-3-(phenylmethyl)-1H-pyrazolo[3,4-d]pyrimidin-4-amine

[476371-80-9] C<sub>17</sub>H<sub>22</sub>N<sub>5</sub>O<sub>13</sub>P<sub>3</sub> 597.3

NA16508

1mg	\$965.20
2mg	\$1754.90
5mg	\$3190.70

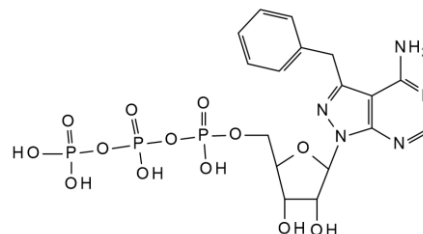

Refs: Hunter, T, et al, Cell, 100, 113 (2000); Habelhah, H, et al, J. Biol. Chem, 276, 18090 (2001); Shah, K, et al, Chem. Biol, 9, 33 (2002)

**8-(4-Amino-(2',3',4',5',6'-D5-biphenyl)-2'-deoxyguanosine**

• N-(2'-Deoxyguanosin-8-yl)-4-amino(biphenyl-2',3',4',5',6'-D5)

C<sub>22</sub>H<sub>17</sub>N<sub>6</sub>O<sub>4</sub>D<sub>5</sub> 439.48

NA04647

250ug	\$710.00
500ug	\$1200.00
1mg	\$2065.00

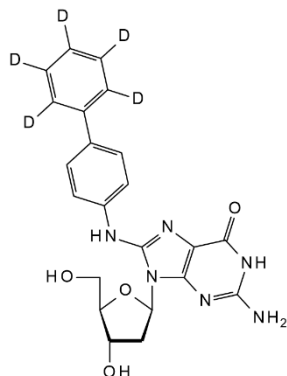

Refs: Beland, F.A, etal, Chem. Res. Toxicol. 1999 12, p68

**5'-Amino-N-Boc-5'-deoxy-2',3'-O-isopropylideneadenosine**

NA46262

1g \$4500.00

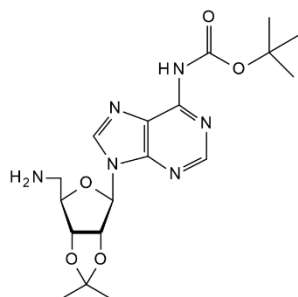
**2-Amino-5-boronopyrimidine**

see 2-Aminopyrimidine-5-boronic acid, NA57424 on page 61

**2-Amino-8-bromo-6-hydroxypurine riboside**

see 8-Bromoguanosine, NB06311 on page 127

**2-Amino-4-(4-bromophenyl)pyrimidine**

• 4-(4-Bromophenyl)pyrimidin-2-amine

[392326-81-7] C<sub>10</sub>H<sub>8</sub>BrN<sub>3</sub> 250.09

NA57404

250mg	\$77.50
500mg	\$125.00
1g	\$260.60

**2-Amino-8-bromopurine riboside**

see 2-Amino-8-bromo-9-(b-D-ribofuranosyl)purine, NA46036 on page 39

**6-Amino-8-bromopurine riboside**

see 8-Bromoadenosine, NB03414 on page 123

**2-Amino-8-bromo-9-(b-D-ribofuranosyl)purine**

• 2-Amino-8-bromopurine riboside

[3001-47-6] C<sub>10</sub>H<sub>12</sub>BrN<sub>5</sub>O<sub>4</sub> 346.14

NA46036

500mg	\$850.00
1g	\$1150.00
2g	\$1700.00

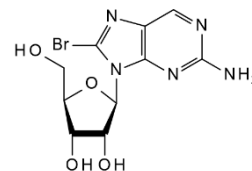
**3'-Amino-5'-O-tert-butylidimethylsilyl-3'-deoxy-D3-thymidine**C<sub>16</sub>H<sub>26</sub>N<sub>3</sub>O<sub>5</sub>SiD<sub>3</sub> 374.52

NA09010

Price On Application

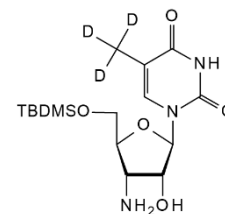

## Aminobutyldi

## 3'-Amino-5'-O-tert-butylidimethylsilyl-3'-deoxythymidine

C<sub>16</sub>H<sub>29</sub>N<sub>3</sub>O<sub>5</sub>Si 371.51

NA09004

Price On Application

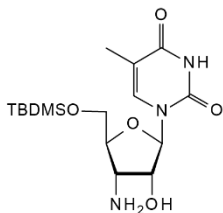

## 3'-Amino-5'-O-tert-butylidimethylsilyl-2',3'-dideoxyuridine

C<sub>15</sub>H<sub>27</sub>N<sub>3</sub>O<sub>4</sub>Si 341.48

NA08216

Price On Application

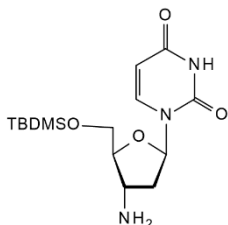

## 3-(Aminocarbonyl)-1-[5-O-[hydroxy(phosphonoxy)phosphinyl]-b-D-ribofuranosyl]pyridinium inner salt P'5'-ester with 3-b-D-ribofuranosyl-3H-imidazo[2,1-i]purine

see *Nicotinamide 1,N6-ethenoadenine dinucleotide*, NN26196 on page 334

## 3-(Aminocarbonyl)-1-b-D-ribofuranosyl-pyridinium bromide

see *Nicotinamide riboside bromide*, NN31173 on page 334

## 3-(Aminocarbonyl)-1-a-D-ribofuranosyl-pyridinium chloride

see *b-Nicotinamide riboside chloride*, NN45059 on page 334

## (3S)-5'-[(3-Amino-3-carboxylatopropyl)methylsulphonio]-5'-deoxyadenosine

see *S-Adenosyl-L-methionine p-toluenesulfonate*, NA04017 on page 28

## L-5'-S-(3-Amino-3-carboxypropyl)-5'-thioadenosine

see *S-(5'-Adenosyl)-L-homocysteine dihydrate*, NA17223 on page 28

## 2-Amino-6-chloro-9-(2'-deoxy-3,5-di-O-benzoyl-2-fluoro-b-D-arabinofuranosyl)purine

[118373-61-8] C<sub>24</sub>H<sub>19</sub>ClFN<sub>5</sub>O<sub>5</sub> 511.89

NA31237

1g	\$367.50
2g	\$546.00
5g	\$1102.50

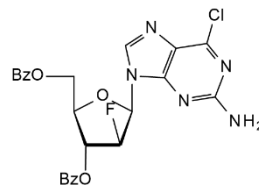

## 2-Amino-6-chloro-9-(2'-deoxy-3',5'-di-O-toluoyl-b-D-ribofuranosyl)purine

C<sub>26</sub>H<sub>24</sub>ClN<sub>5</sub>O<sub>5</sub> 521.95

NA09005

100mg	\$158.00
250mg	\$367.50
500mg	\$630.00

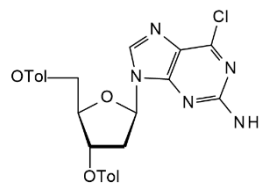

## 2-Amino-6-chloro-9-(2'-deoxy-b-D-erythro-pentofuranosyl)-9H-purine

see *2-Amino-6-chloro-9-(2'-deoxy-b-D-ribofuranosyl)purine*, NA02926 on page 41

## 6-Amino-2-chloro-9-(2'-deoxy-2'-fluoro-b-D-arabinofuranosyl)purine

- Clofarabine
- 2-Chloro-6-amino-purine-2'-fluoro-2'-deoxy arabinoside

[123318-82-1] C<sub>10</sub>H<sub>11</sub>ClFN<sub>5</sub>O<sub>3</sub> 303.68

NA07154

250mg	\$70.00
500mg	\$115.00
1g	\$210.00

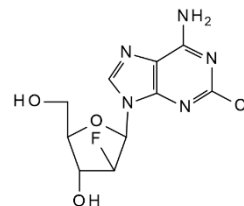

Refs: Gandhi V, et al, Clin. Cancer Res. 2003, 9, p6335; Kantarjian H, et al, Blood 2003, 102, p2379; Faderl S, et al, Cancer 2005, 105, p1985

**2-Amino-6-chloro-9-(2'-deoxy-b-D-ribofuranosyl)purine-5'-triphosphate**C<sub>10</sub>H<sub>17</sub>ClN<sub>5</sub>O<sub>12</sub>P<sub>3</sub> 527.64

NA09401

1ug	\$126.00
5ug	\$472.50
10ug	\$735.00

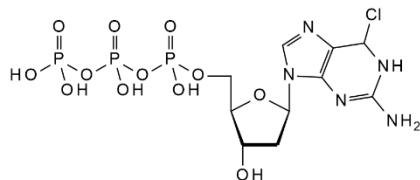
**2-Amino-6-chloro-9-(2'-deoxy-b-D-ribofuranosyl)purine**

• 2-Amino-6-chloro-9-(2-deoxy-b-D-erythro-pentofuranosyl)-9H-purine

[120595-72-4] C<sub>10</sub>H<sub>12</sub>ClN<sub>5</sub>O<sub>3</sub> 285.69

NA02926

50mg	\$85.00
100mg	\$150.00
250mg	\$275.00

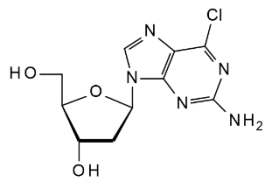

Refs: Okuyama K, Shibuya S, Hamamoto T, et al, Biosci. Biotechnol. Biochem. 2003, 67, p889

**4-Amino-5-chloro-2,6-dimethylpyrimidine**[2858-20-0] C<sub>6</sub>H<sub>8</sub>ClN<sub>3</sub> 157.6

NA67922

5g	\$47.50
10g	\$80.00
25g	\$160.00

**4-Amino-2-chloro-5-fluoropyrimidine**

[155-10-2]

NA44305

Price On Application

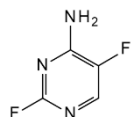
**2-Amino-6-chloro-4-methoxypyrimidine**[5734-64-5] C<sub>5</sub>H<sub>6</sub>ClN<sub>2</sub>O 159.57

NA11514

10g	\$30.30
25g	\$48.50
50g	\$77.50

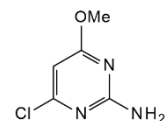
**2-Amino-6-chloro-7-methylpurine riboside**

see 2-Amino-6-chloro-7-methyl-9-(b-D-ribofuranosyl)purine, NA08965 on page 41

**2-Amino-4-chloro-6-methylpyridine**

[36340-61-1]

NA66773

100g	\$50.00
250g	\$90.00
500g	\$150.00

**2-Amino-6-chloro-7-methyl-9-(b-D-ribofuranosyl)purine**

• 2-Amino-6-chloro-7-methylpurine riboside

C<sub>11</sub>H<sub>16</sub>ClN<sub>5</sub>O<sub>4</sub> 317.73

NA08965

50mg	\$157.50
100mg	\$263.00
250mg	\$472.50

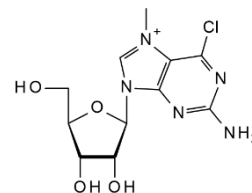
**2-Amino-4-chloro-7-(2-C-methyl-b-D-ribofuranosyl)-7H-pyrrolo[2,3-d]pyrimidine**[443642-40-8] C<sub>12</sub>H<sub>15</sub>ClN<sub>4</sub>O<sub>4</sub> 314.72

NA34901

Price On Application



**Amino chlorop****2-Amino-4-(4-chlorophenyl)pyrimidine**

• 4-(4-Chlorophenyl)pyrimidin-2-amine

[133256-51-6] C<sub>10</sub>H<sub>8</sub>ClN<sub>3</sub> 205.64

NA57403

25mg	\$50.00
50mg	\$80.00
100mg	\$128.00

**4-Amino-6-chloropyrimidine-5-carbaldehyde**

• 4-Amino-6-chloro-5-pyrimidinecarbaldehyde

[14160-93-1] C<sub>5</sub>H<sub>4</sub>ClN<sub>2</sub>O 157.56

NA57367

500mg	\$60.00
1g	\$116.80
2g	\$186.90

**2-Amino-6-chloropurine-9-b-D-ribose**

see 2-Amino-6-chloro-9-(b-D-ribofuranosyl)purine, NA04201 on page 43

**6-Amino-2-chloropurine riboside**

see 2-Chloroadenosine, NC06293 on page 140

**(1S,4R)-4-(2-Amino-6-chloro-9H-purin-9-yl)-2-cyclopentene-1-methanol hydrochloride**

• (1S-cis)-4-(2-Amino-6-chloro-9H-purin-9-yl)-2-cyclopentene-1-methanol monohydrochloride

[172015-79-1] C<sub>11</sub>H<sub>13</sub>Cl<sub>2</sub>N<sub>5</sub>O 302.16

NA17659

100mg	\$55.00
250mg	\$110.00
500mg	\$175.00

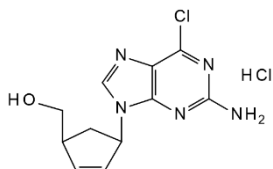
**(1S-cis)-4-(2-Amino-6-chloro-9H-purin-9-yl)-2-cyclopentene-1-methanol monohydrochloride**

see (1S,4R)-4-(2-Amino-6-chloro-9H-purin-9-yl)-2-cyclopentene-1-methanol hydrochloride, NA17659 on page 42

**1-(6-Amino-2-chloro-9H-purin-9-yl)-1-deoxy-N-ethyl-2,3-O-(1-methylethylidene)-b-D-ribofuranuronamide**

see 2-Chloro-5'-N-ethylcarboxamide-2',3'-O-isopropylidene adenosine, NC16518 on page 145

**4-Amino-6-chloro-5-pyrimidinecarbaldehyde**

see 4-Amino-6-chloropyrimidine-5-carbaldehyde, NA57367 on page 42

**4-Amino-2-chloro-5-pyrimidinecarbonitrile**

[94741-69-2]

NA44321

Price On Application

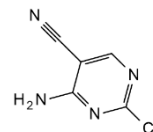
**4-Amino-6-chloro-1-b-D-ribofuranosylimidazo[4,5-c]pyridine**

see 2-Chloro-3-deazaadenosine, NC09808 on page 141

**2-Amino-6-chloro-(b-D-ribofuranosyl)purine-5'-triphosphate**C<sub>10</sub>H<sub>15</sub>ClN<sub>5</sub>O<sub>13</sub>P<sub>3</sub> 541.63

NA09403

1ug	\$126.00
5ug	\$472.50
10ug	\$735.00

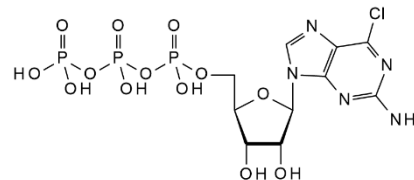

**2-Amino-6-chloro-9-(b-D-ribofuranosyl)purine**

- 6-Chloroguanine riboside
- 6-Chloroguanosine
- 2-Amino-6-chloropurine-9-b-D-ribose

[2004-07-1] C<sub>10</sub>H<sub>12</sub>ClN<sub>5</sub>O<sub>4</sub> 301.69

NA04201	5g	\$70.00
	10g	\$105.00
	25g	\$175.00

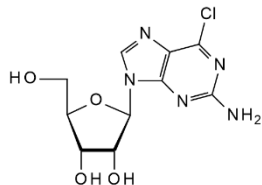
**2-Amino-6-chloro-9-(2',3',5'-tri-O-acetyl-b-D-ribofuranosyl)purine**

NA145604	1g	\$50.00
	2g	\$80.00
	5g	\$120.00

**6-Amino-2-chloro-9-(2',3',5'-tri-O-acetyl-b-D-ribofuranosyl)purine**

see 2',3',5'-Tri-O-acetyl-2-chloroadenosine, NT20146 on page 370

**6-Amino-2-chloro-9-(2',3',5'-tri-O-acetyl-b-D-ribofuranosyl)purine**

- 2-Chloro-6-amino-9-(2',3',5'-tri-O-acetyl-b-D-ribofuranosyl)purine

C<sub>18</sub>H<sub>18</sub>ClN<sub>5</sub>O<sub>7</sub> 427.8

NA05212	50mg	\$68.50
	100mg	\$116.00
	250mg	\$237.50

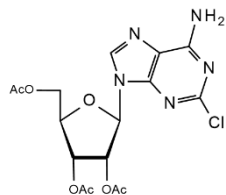
**4-Amino-5-cyano-7-(b-D-ribofuranosyl)pyrrolo[2,3-d]pyrimidine**

see Toyocamycin, NT44985 on page 369

**(1S,4R)-4-[2-Amino-6-(cyclopropylamino)-9H-purin-9-yl]-2-cyclopentene-1-carboxylic acid**

see Abacavir carboxylate, NA16897 on page 9

**(1S,4R)-4-[2-Amino-6-(cyclopropylamino)-9H-purin-9-yl]-2-cyclopentene-1-methanoldihydrogen phosphate (ester)**

see Abacavir 5'-phosphate, NA16495 on page 9

**(1R,4R)-rel-4-[2-amino-6-(cyclopropylamino)-9H-purin-9-yl]-2-cyclopentene-1-methanol hydrochloride**

see trans-Abacavir hydrochloride, NA16496 on page 9

**(1R-cis)-4-[2-Amino-6-(cyclopropylamino)-9H-purin-9-yl]-2-cyclopentene-1-methanol**

see ent-abacavir, NE16540 on page 267

**(1R,4S)-4-[2-Amino-6-(cyclopropylamino)-9H-purin-9-yl]-2-cyclopentene-1-methanol**

see ent-abacavir, NE16540 on page 267

**2-Amino-4-(cyclopropyl)pyrimidine**

[21573-15-9]

NA44328

Price On Application

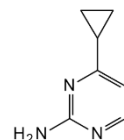
**N4-Aminocytidine**[57294-74-3] C<sub>9</sub>H<sub>14</sub>N<sub>4</sub>O<sub>5</sub> 258.23

NA07954	25mg	\$65.00
	50mg	\$95.00
	100mg	\$158.00

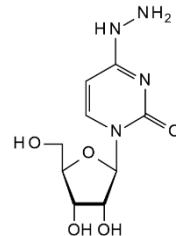

## Aminodansyla

## 8-Amino[1''-(N''-dansyl)-4''-aminobutyl]-5'-(1-aziridiny)-5'-deoxyadenosine

[256953-68-1] C<sub>28</sub>H<sub>37</sub>N<sub>9</sub>O<sub>5</sub>S 611.72

NA16503

1mg	\$181.70
2mg	\$330.40
5mg	\$600.60

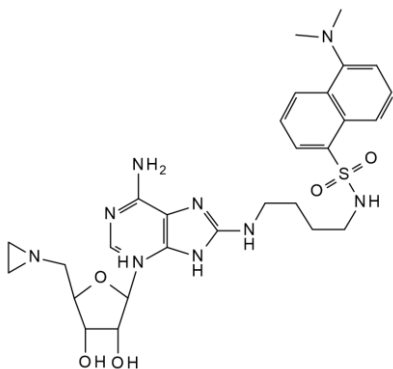

Refs: Plijevaljic, G, et al, J.A.C.S., 125, 3486 (2003)



## 3'-Amino-ddATP.Li

see 3'-Amino-2',3'-dideoxyadenosine-5'-triphosphate lithium salt - 100 mM aqueous solution, NA71664 on page 50

## 3'-Amino-ddCTP.Li

see 3'-Amino-2',3'-dideoxycytidine-5'-triphosphate lithium salt - 100 mM aqueous solution, NA71665 on page 50

## 3'-Amino-ddGTP.Li

see 3'-Amino-2',3'-dideoxyguanosine-5'-triphosphate lithium salt - 100 mM aqueous solution, NA71666 on page 51

## 3'-Amino-ddTTP.xLi

see 3'-Amino-2',3'-dideoxythymidine-5'-triphosphate lithium salt - 100 mM aqueous solution, NA71667 on page 52

## 5'-Amino-5'-deoxyadenosine hydrochloride

[14365-44-7] C<sub>10</sub>H<sub>14</sub>N<sub>6</sub>O<sub>3</sub> 266.26

NA03337

1mg	\$120.00
2mg	\$188.00
5mg	\$375.00

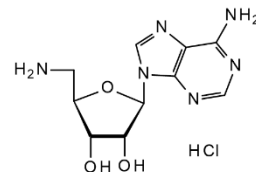

Refs: Poon A, Sawynok J, Eur. J. Pharmacol. 1995, 286, p177; Langer et.al, Chem. Bio. Che, 2004, 5, p1508



## 2'-Amino-2'-deoxyadenosine-5'-triphosphate

C<sub>10</sub>H<sub>17</sub>N<sub>6</sub>O<sub>12</sub>P<sub>3</sub> 506.2

NA09398

1ug	\$126.00
5ug	\$420.00
10ug	\$735.00

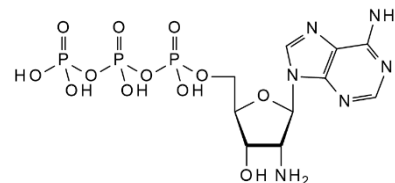

## 3'-O-Amino-2'-deoxyadenosine 5'-triphosphate

[1220515-87-6] C<sub>10</sub>H<sub>17</sub>N<sub>6</sub>O<sub>12</sub>P<sub>3</sub> 506.2

NA145313

Price On Application





**2'-Amino-2'-deoxyadenosine**

- 2'-Amino-D-adenosine
- 2,6-Diaminopurine-2'-deoxyriboside

[10414-81-0] C<sub>10</sub>H<sub>14</sub>N<sub>6</sub>O<sub>3</sub> 266.26

NA02636	50mg	\$75.00
	100mg	\$125.00
	250mg	\$185.00

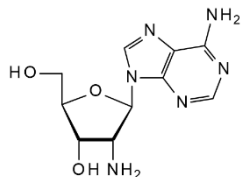

Refs: Muraoka M, Iida A, Takahashi S, et al, Nucleoside Nucleotides 1991; Bressi et.al, J. Med. Chem, 2001, 44, p2080

**2-Amino-2'-deoxyadenosine**

- 9-(2-Deoxy-b-D-ribofuranosyl)-2,6-Diaminopurine
- 2,6-Diaminopurine 2'-deoxyriboside

[4546-70-7] C<sub>10</sub>H<sub>14</sub>N<sub>6</sub>O<sub>3</sub> 266.26

NA06287	5g	\$45.00
	10g	\$80.00
	25g	\$150.00

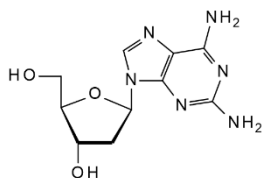

Refs: Shealy YF, O'Dell CA, Shannon WM, Arnett G, J. Med. Chem. 1984

**3'-Amino-3'-deoxyadenosine**

- 3'-Amino-D-adenosine
- 9-(3-Amino-3-deoxy-b-D-ribofuranosyl)-adenine

[2504-55-4] C<sub>10</sub>H<sub>14</sub>N<sub>6</sub>O<sub>3</sub> 266.26

NA03336	1mg	\$95.00
	2mg	\$170.00
	5mg	\$350.00

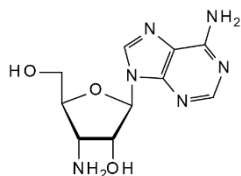

Refs: Baker BR, Schaub RE, Kissman HM, J. Am. Chem. Soc. 1955, 20, p5911; Trumann & Klenow, Mol. Pharmacol, 1968, 4, p77

**3'-O-Amino-2'-deoxyadenosine**[132471-87-5] C<sub>10</sub>H<sub>14</sub>N<sub>6</sub>O<sub>3</sub> 266.26

NA145312

Price On Application

**2'-Amino-2'-deoxycytidine-5'-triphosphate**C<sub>9</sub>H<sub>17</sub>N<sub>4</sub>O<sub>13</sub>P<sub>3</sub> 482.17

NA09399

1 ug	\$105.00
5ug	\$446.30
10ug	\$735.00

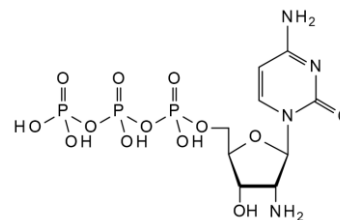
**3'-O-Amino-2'-deoxycytidine 5'-triphosphate**[1220515-75-2] C<sub>9</sub>H<sub>17</sub>N<sub>4</sub>O<sub>13</sub>P<sub>3</sub> 482.17

NA145310

Price On Application

**2'-Amino-2'-deoxycytidine**[26889-42-9] C<sub>9</sub>H<sub>14</sub>N<sub>4</sub>O<sub>4</sub> 242.24

NA02637

25mg	\$58.00
50mg	\$89.50
100mg	\$137.00

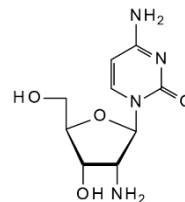

Refs: Lin TS, Zhang XH, Wang ZH, Prusoff WH, J. Med. Chem. 1988,31,p484

**Aminodeoxycy****3'-Amino-3'-deoxycytidine**[70580-89-1] C<sub>9</sub>H<sub>14</sub>N<sub>4</sub>O<sub>4</sub> 242.23

NA12252

1mg	\$115.00
2mg	\$190.00
5mg	\$350.00

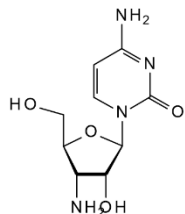
**3'-O-Amino-2'-deoxycytidine**[103251-39-4] C<sub>9</sub>H<sub>14</sub>N<sub>4</sub>O<sub>4</sub> 242.23

NA145311

Price On Application

**2'-Amino-2'-deoxy-2,6-diaminopurine-D-riboside**

see 2,6-Diamino-9-(2'-amino-2'-deoxy-b-D-ribofuranosyl)purine, ND06322 on page 230

**4-Amino-1-(deoxy-2,2-difluoro-D-threo-pentofuranosyl)-2(1H)-pyrimidinone**

see 3'-Epi gemcitabine, NE22706 on page 268

**3'-Amino-3'-deoxy-5'-O-DMT-thymidine**C<sub>31</sub>H<sub>33</sub>N<sub>3</sub>O<sub>8</sub> 543.61

NA09011

25mg	\$68.50
50mg	\$100.00
100mg	\$158.00

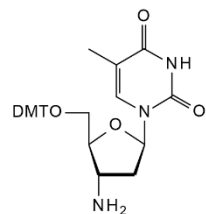
**2-Amino-8-(2-deoxy-b-D-erythro-pentofuranosyl)-imidazo[1,2-a]-1,3,5-triazin-4(8H)-one**

see 2-Amino-8-(2-deoxy-b-D-ribofuranosyl)-imidazo[1,2-a]-1,3,5-triazin-4(8H)-one, NA145593 on page 48

**4-Amino-5-(2-deoxy-b-D-erythro-pentofuranosyl)-1-methyl-2(1H)-pyrimidinone**

see 4-Amino-5-(2-deoxy-b-D-ribofuranosyl)-1-methyl-2(1H)-pyrimidinone, NA145600 on page 48

**2-Amino-2'-deoxy-2'-fluoroadenosine**

- 9-(2-Fluoro-2-deoxy-b-D-ribofuranosyl)-2,6-diaminopurine
- 2'-Deoxy-2'-fluoro-diaminopurine riboside
- 2,6-Diamino-9-(2'-deoxy-2'-fluoro-b-D-ribofuranosyl)purine

[134444-47-6] C<sub>10</sub>H<sub>13</sub>FN<sub>6</sub>O<sub>3</sub> 284.25

NA05649

50mg	\$65.00
100mg	\$100.00
250mg	\$162.50

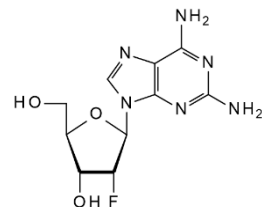
**2'-Amino-2'-deoxyguanosine-5'-triphosphate tetralithium salt**C<sub>10</sub>H<sub>17</sub>N<sub>6</sub>O<sub>13</sub>P<sub>3</sub>Li<sub>4</sub> 549.96

NA09400

500ug	\$160.00
1mg	\$294.00
2.5mg	\$656.30

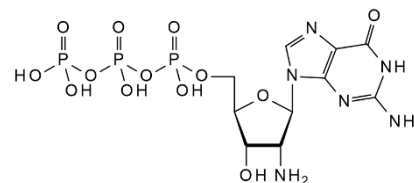

**2'-Amino-2'-deoxyguanosine**

• 9-(2-amino-2-deoxy-b-D-ribofuranosyl)-guanine

[60966-26-9] C<sub>10</sub>H<sub>14</sub>N<sub>6</sub>O<sub>4</sub> 282.26

NA05235

50mg	\$60.00
100mg	\$99.00
250mg	\$102.50

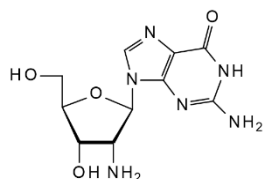

Refs: Stromberg R, Hahne S, Sjogren AS, et al, Biochem. Biophys. Res. Commun. 1992, 183, p842

**3'-Amino-3'-deoxyguanosine**[80015-76-5] C<sub>10</sub>H<sub>14</sub>N<sub>6</sub>O<sub>4</sub> 282.3

NA03340

5mg	\$80.00
10mg	\$130.00
25mg	\$225.00

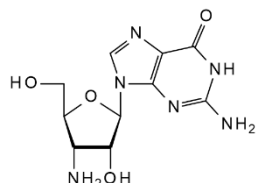

Refs: Zhang L, Cui Z, Zhang B, HELVETICA CHIMICA ACTA 2003, 86, 3, p703; Zielinski, Orgel, Nucl. Acids Res, 2006, 34, p614

**5'-Amino-5'-deoxyguanosine**[4099-84-7] C<sub>10</sub>H<sub>14</sub>N<sub>6</sub>O<sub>4</sub> 282.26

NA16031

2mg	\$126.00
5mg	\$288.80
10mg	\$556.50

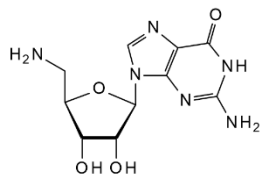
**2'-Amino-2'-deoxyinosine**

• 9-(2-Amino-2-deoxy-b-D-ribofuranosyl)-hypoxanthine

[75763-51-8] C<sub>10</sub>H<sub>13</sub>N<sub>5</sub>O<sub>4</sub> 267.24

NA05779

100mg	\$84.00
500mg	\$185.00
1g	\$315.00

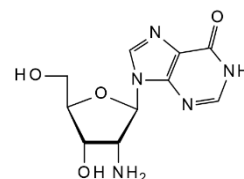

Refs: Banoub J, Boullanger P, Lafont D, Chem. Rev. 1992, Vol 92, p1167-1195

**4-Amino-1-[2-deoxy-3,5-bis-O-(4-methylbenzoyl)-β-D-erythro-pentofuranosyl]-1,3,5-triazin-2(1H)-one**

see 1-(2'-Deoxy-3',5'-di-O-toluoyl-b-D-ribofuranosyl)-4-amino-1,2-dihydro-2-oxo-1,3,5-triazine, ND04704 on page 180

**5'-Amino-5'-deoxy-2'-O-methyluridine**

NA137609

Price On Application

**3'-Amino-3'-deoxy-5'-O-MMT-D3-thymidine**C<sub>30</sub>H<sub>28</sub>N<sub>3</sub>O<sub>5</sub>D<sub>3</sub> 516.62

NA09013

Price On Application

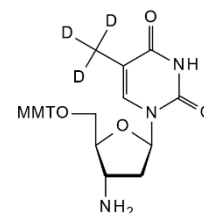
**4-Amino-7-[2-deoxy-5-O-[hydroxy[[hydroxy(phosphonoxy)phosphinyl]oxy]phosphinyl]-β-D-erythro-pentofuranosyl]-1,7-dihydro-2H-pyrrolo[2,3-d]pyrimidin-2-one**

see 2'-Deoxy-7-deazaisoguanosine triphosphate, ND139290 on page 177

## Aminodeoxyps

## 6-Amino-9-(1-deoxy-b-D-psicofuranosyl)purine

[16848-12-7] C<sub>11</sub>H<sub>15</sub>N<sub>5</sub>O<sub>4</sub> 281.27

NA31829

Price On Application

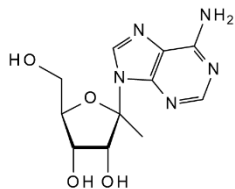

## 9-(2-amino-2-deoxy-b-D-ribofuranosyl)-guanine

see 2'-Amino-2'-deoxyguanosine, NA05235 on page 47

## 9-(3-Amino-3-deoxy-b-D-ribofuranosyl)-adenine

see 3'-Amino-3'-deoxyadenosine, NA03336 on page 45

## 9-(2-Amino-2-deoxy-b-D-ribofuranosyl)-2,6-diaminopurine

see 2,6-Diamino-9-(2'-amino-2'-deoxy-b-D-ribofuranosyl)purine, ND06322 on page 230

## 9-(2-Amino-2-deoxy-b-D-ribofuranosyl)-hypoxanthine

see 2'-Amino-2'-deoxyinosine, NA05779 on page 47

## 2-Amino-8-(2-deoxy-b-D-ribofuranosyl)-imidazo[1,2-a]-1,3,5-triazin-4(8H)-one

• 2-Amino-8-(2-deoxy-b-D-erythro-pentofuranosyl)-imidazo[1,2-a]-1,3,5-triazin-4(8H)-one

[110457-87-9] C<sub>10</sub>H<sub>13</sub>N<sub>5</sub>O<sub>4</sub> 267.24

NA145593

50mg	\$300.00
100mg	\$495.00
250mg	\$1125.00



## 2-Amino-1-(2-deoxy-b-D-ribofuranosyl)-5-methyl-4(1H)-pyrimidinone

see 2'-Deoxy-5-methylisocytidine, ND144597 on page 216

## 4-Amino-5-(2-deoxy-b-D-ribofuranosyl)-1-methyl-2(1H)-pyrimidinone

• 4-Amino-5-(2-deoxy-b-D-erythro-pentofuranosyl)-1-methyl-2(1H)-pyrimidinone

[1166395-05-6] C<sub>10</sub>H<sub>15</sub>N<sub>3</sub>O<sub>4</sub> 241.24

NA145600

50mg	\$250.00
100mg	\$450.00
250mg	\$1025.00



## 2-Amino-9-(2'-deoxy-b-D-ribofuranosyl)purine

[3616-24-8] C<sub>10</sub>H<sub>13</sub>N<sub>5</sub>O<sub>3</sub> 251.24

NA02525

25mg	\$75.00
50mg	\$130.00
100mg	\$225.00

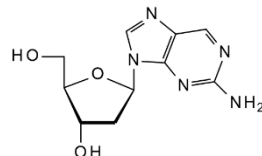

## 4-Amino-1-(2-deoxy-b-D-ribofuranosyl)-1,3,5-triazin-2(1H)-one

see 5-Aza-2'-deoxycytidine, NA02969 on page 78

## 3'-Amino-3'-deoxy-D3-thymidine

C<sub>10</sub>H<sub>12</sub>N<sub>3</sub>O<sub>4</sub>D<sub>3</sub> 244.27

NA09014

Price On Application

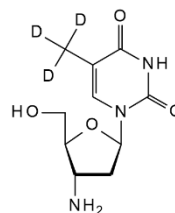

**3'-Amino-3'-deoxythymidine**

• 3'-Amino-D-thymidine

[52450-18-7] C<sub>10</sub>H<sub>15</sub>N<sub>3</sub>O<sub>4</sub> 241.24

NA02831

500mg	\$40.00
1g	\$62.70
2g	\$96.40

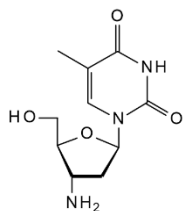

Refs: North TW, Cronn RC, Remington KM, et al, Antimicrob. Agents Chemother. 1990, 34, p1505; Qian M, et al, Biochem. Pharmacol. 1994, 48, p383; Diwan B, et al, Toxicol. Appl. Pharmacol. 1999, 161, p82; Lim S, et al, J. Biol. Chem. 2001, 276, p23616; Van Tungen L, et al, Carcinogenesis 2002, 23, p1427

**5'-Amino-5'-deoxythymidine**[25152-20-9] C<sub>10</sub>H<sub>15</sub>N<sub>3</sub>O<sub>4</sub> 241.24

NA06395

25mg	\$72.50
50mg	\$125.00
100mg	\$210.00

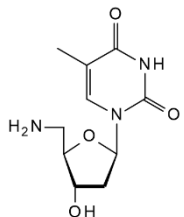
**3'-Amino-3'-deoxy-5'-O-trityl-D3-thymidine**C<sub>29</sub>H<sub>26</sub>N<sub>3</sub>O<sub>4</sub>D<sub>3</sub> 486.58

NA09016

Price On Application

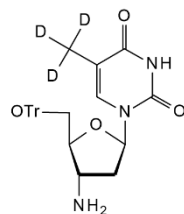
**2'-Amino-2'-deoxyuridine-5'-triphosphate**C<sub>9</sub>H<sub>16</sub>N<sub>3</sub>O<sub>14</sub>P<sub>3</sub> 483.16

NA09402

1ug	\$105.00
5ug	\$420.00
10ug	\$735.00

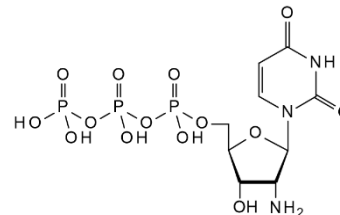
**2'-Amino-2'-deoxyuridine**

• 2'-Amino-2'-deoxyuridine

[26889-39-4] C<sub>9</sub>H<sub>13</sub>N<sub>3</sub>O<sub>5</sub> 243.22

NA05270

250mg	\$80.00
500mg	\$135.00
1g	\$210.00

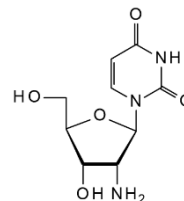

Refs: Imazawa M, Eckstein F, J. Org. Chem, 1979, 44, 12, p2039

**3'-Amino-3'-deoxyuridine**[70580-90-4] C<sub>9</sub>H<sub>13</sub>N<sub>3</sub>O<sub>5</sub> 243.22

NA12253

Price On Application

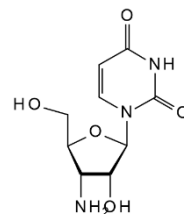
**4-Amino-1-(3,5-di-O-benzoyl-2-deoxy-2,2-difluoro-α-D-erythro-pentofuranosyl)-2(1H)-pyrimidinone**

see 1'-Epi gemcitabine 3',5'-dibenzoate, NE16710 on page 268

**Aminodideoxy****3'-Amino-2',3'-dideoxyadenosine-5'-triphosphate lithium salt - 100 mM aqueous solution**

• 3'-Amino-ddATP.Li

C<sub>10</sub>H<sub>17</sub>N<sub>6</sub>O<sub>11</sub>P<sub>3</sub>·xLi 490.20 (free acid basis)

NA71664	500ug	\$300.00
	1mg	\$550.00
	2mg	\$1010.00

**3'-Amino-2',3'-dideoxyadenosine**

• 9-(3-Amino-2,3-dideoxy-b-D-erythro-pentafuranosyl)adenine

• 9-(3-Amino-2,3-dideoxy-1-D-ribofuranosyl) hypoxanthine

[7403-25-0] C<sub>10</sub>H<sub>14</sub>N<sub>6</sub>O<sub>2</sub> 250.26

NA05223	500mg	\$55.00
	1g	\$100.00
	2g	\$170.00

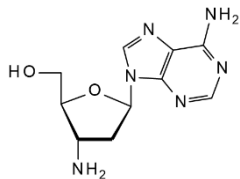

Refs: Anderson CD, Lee WW, Goodman L, et al. J. Am. Chem. Soc. 1961, 83, p1900

**3'-Amino-2',3'-dideoxycytidine-5'-triphosphate lithium salt - 100 mM aqueous solution**

• 3'-Amino-ddCTP.Li

C<sub>9</sub>H<sub>17</sub>N<sub>4</sub>O<sub>12</sub>P<sub>3</sub>·xLi 466.17 (free acid basis)

NA71665	1mg	\$685.00
	2mg	\$1000.00
	5mg	\$2125.00

**3'-Amino-2',3'-dideoxycytidine**

• 3'-Amino-2',3'-dideoxycytidine

• 1-(3-Amino-2,3-dideoxy-b-D-ribofuranosyl)cytosine

[84472-90-2] C<sub>8</sub>H<sub>14</sub>N<sub>4</sub>O<sub>3</sub> 226.23

NA05183	50mg	\$50.00
	100mg	\$85.00
	250mg	\$125.00

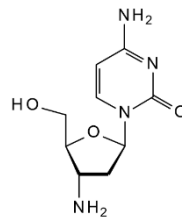

Refs: Krenitsky TA, Freema GA, Shaver SR, Beacham LM, Hurkbert S, Cohn NK, Elwell LP, Selway JWT, J. Med. Chem. 1983, 26, p891

**3'-Amino-2',3'-dideoxy-2,6-diaminopurine riboside**

see 2,6-Diamino-9-(3'-amino-2',3'-dideoxy-b-D-ribofuranosyl)purine, ND05219 on page 230

**3'-Amino-2',3'-dideoxy-2,6-diaminopurine riboside**

• 2-Amino-3'-amino-2',3'-dideoxyadenosine

[915399-37-0] C<sub>10</sub>H<sub>15</sub>N<sub>7</sub>O<sub>2</sub> 265.27

NA46160	50mg	\$65.00
	100mg	\$100.00
	250mg	\$170.00

**3'-Amino-2',3'-dideoxy-5'-O-DMT-N2-isobutrylguanosine**C<sub>35</sub>H<sub>38</sub>N<sub>6</sub>O<sub>6</sub> 638.71

NA08378	50mg	\$157.50
	100mg	\$263.00
	250mg	\$577.50

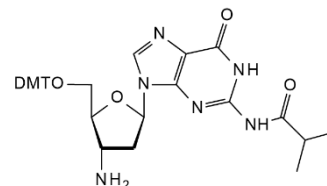
**9-(3-Amino-2,3-dideoxy-b-D-erythro-pentafuranosyl)adenine**

see 3'-Amino-2',3'-dideoxyadenosine, NA05223 on page 50

**3'-Amino-2',3'-dideoxy-2-fluoroadenosine**

• 9-(3-Amino-2,3-dideoxy-b-D-ribofuranosyl)-2-fluoroadenine

C<sub>10</sub>H<sub>13</sub>FN<sub>6</sub>O<sub>2</sub> 268.25

NA07912

50mg	\$58.00
100mg	\$105.00
250mg	\$210.00

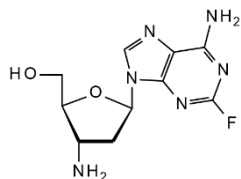
**6-Amino-9-(2',3'-dideoxy-2'-fluoro-b-D-arabinofuranosyl)purine**• [(2S,4S,5R)-5-(6-Aminopurin-9-yl)-4-fluorooxolan-2-yl]methanol  
• Lodenosine[110143-10-7] C<sub>10</sub>H<sub>12</sub>FN<sub>5</sub>O<sub>2</sub> 253.24

NA05179

25mg	\$750.00
50mg	\$1000.00
100mg	\$1500.00

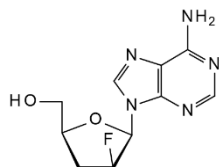
**5'-Amino-2',5'-dideoxy-2'-fluorouridine**

NA137611

Price On Application

**3'-Amino-2',3'-dideoxyguanosine-5'-triphosphate lithium salt - 100 mM aqueous solution**

• 3'-Amino-ddGTP.Li

C<sub>10</sub>H<sub>17</sub>N<sub>6</sub>O<sub>12</sub>P<sub>3</sub>·xLi 506.20 (free acid basis)

NA71666

500ug	\$325.00
1mg	\$550.00
2mg	\$1000.00

**3'-Amino-2',3'-dideoxyguanosine**

• 9-(3-Amino-2,3-dideoxy-b-D-ribofuranosyl)guanine

[66323-49-7] C<sub>10</sub>H<sub>14</sub>N<sub>6</sub>O<sub>3</sub> 266.26

NA02832

250mg	\$50.00
500mg	\$85.00
1g	\$120.00

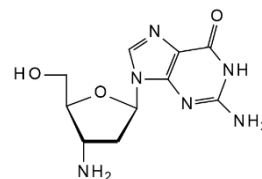

Refs: Herrlein MK, Konrad E, Helv. Chim. Acta 1994, 77, 2, p586

**3'-Amino-2',3'-dideoxyinosine**

• 9-(3-Amino-2,3-dideoxy-b-D-ribofuranosyl)-hypoxanthine

C<sub>10</sub>H<sub>13</sub>N<sub>5</sub>O<sub>3</sub> 251.24

NA03403

100mg	\$60.00
250mg	\$95.00
500mg	\$125.00

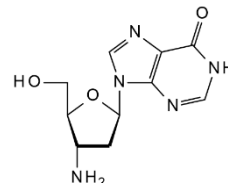

Refs: Krenitsky TA, Freema GA, Shaver SR, Beacham LM, Hurbert S, Cohn NK, Elwell LP, Selway JWT, J. Med. Chem. 1983, 26, p891

**3'-Amino-2',3'-dideoxy-5-methylcytidine**[87190-81-6] C<sub>10</sub>H<sub>16</sub>N<sub>4</sub>O<sub>3</sub> 240.26

NA05652

Price On Application

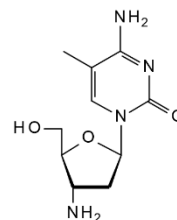

Refs: Matthes E, Reimer K, von Janta-Lipinski M, Meisel H and Lehmann C, Antimicrob Agents Chemother. 1991,35, p1254

**9-(3-Amino-2,3-dideoxy-1-D-ribofuranosyl) hypoxanthine**

see 3'-Amino-2',3'-dideoxyadenosine, NA05223 on page 50

## Aminodideoxy

## 1-(3-Amino-2,3-dideoxy-b-D-ribofuranosyl)cytosine

see 3'-Amino-2',3'-dideoxycytidine, NA05183 on page 50

## 9-(3-Amino-2,3-dideoxy-b-D-ribofuranosyl)-2,6-diaminopurine

see 2,6-Diamino-9-(3'-amino-2',3'-dideoxy-b-D-ribofuranosyl)purine, ND05219 on page 230

## 9-(3-Amino-2,3-dideoxy-b-D-ribofuranosyl)-2-fluoroadenine

see 3'-Amino-2',3'-dideoxy-2-fluoroadenosine, NA07912 on page 51

## 9-(3-Amino-2,3-dideoxy-b-D-ribofuranosyl)guanine

see 3'-Amino-2',3'-dideoxyguanosine, NA02832 on page 51

## 9-(3-Amino-2,3-dideoxy-b-D-ribofuranosyl)hypoxanthine

see 3'-Amino-2',3'-dideoxyinosine, NA03403 on page 51

## 3'-Amino-2',3'-dideoxythymidine-5'-triphosphate lithium salt - 100 mM aqueous solution

• 3'-Amino-ddTTP.xLi

C<sub>10</sub>H<sub>18</sub>N<sub>3</sub>O<sub>13</sub>P<sub>3</sub> 481.18

NA71667

500ug	\$175.00
1mg	\$325.00
2mg	\$610.00



## 3'-Amino-2',3'-dideoxy-5'-O-toluyluridine

C<sub>17</sub>H<sub>19</sub>N<sub>3</sub>O<sub>5</sub> 345.35

NA08269

Price On Application

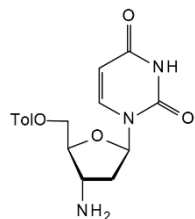

## 4-Amino-1-[3,3-difluoro-4-hydroxy-5-(hydroxymethyl)oxolan-2-yl]pyrimidin-2-one

see 2'-Deoxy-2',2'-difluorocytidine, ND04237 on page 178

## rel-2-Amino-1,9-dihydro-9-[(1R,4S)-4-(hydroxymethyl)-2-cyclopenten-1-yl]-6H-purin-6-one

see Carbovir, NC16517 on page 136

## 4-Amino-1-[(1R,4R,5S)-4,5-dihydroxy-3-(hydroxymethyl)-2-cyclopenten-1-yl]-2(1H)-pyrimidinone

see Cyclopentenyl cytosine, NC58281 on page 158

## 4-amino-1-[(1R,2S,3R,4R)-2,3-dihydroxy-4-(hydroxymethyl)cyclopentyl]pyrimidin-2-one

see Carbodine, NC15795 on page 136

## 4-Amino-2,6-dihydroxy-5-nitrosopyrimidine

• 4-Amino-2,6-dihydroxy-5-nitrosopyrimidine

[5442-24-0] C<sub>4</sub>H<sub>4</sub>N<sub>4</sub>O<sub>3</sub> 156.1

NA70257

1g	\$37.98
2g	\$60.76
5g	\$121.50



## 4-Amino-2,6-dimethoxypyrimidine

[3289-50-7] C<sub>6</sub>H<sub>8</sub>N<sub>2</sub>O<sub>2</sub> 155.15

NA11521

50g	\$60.00
100g	\$90.00
250g	\$160.00

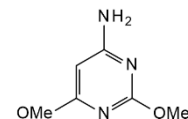

## 4-Amino-2,6-dimethyl-8-(2'-deoxy-3',5'-di-O-toluyl-a-D-ribofuranosyl)-7-pteridone

C<sub>29</sub>H<sub>29</sub>N<sub>5</sub>O<sub>6</sub> 543.57

NA07206

500ug	\$105.00
1mg	\$189.00
2mg	\$315.00

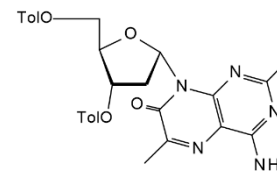



**4-Amino-2,6-dimethyl-8-(2'-deoxy-3',5'-di-O-toluoyl-b-D-ribofuranosyl)-7-pteridone**C<sub>29</sub>H<sub>29</sub>N<sub>5</sub>O<sub>6</sub> 543.57

NA07207

500ug	\$105.00
1mg	\$189.00
2mg	\$315.00

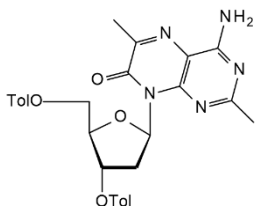
**4-Amino-2,6-dimethyl-8-(2'-deoxy-3',5'-di-O-toluoyl-D-ribofuranosyl)-7-pteridone**C<sub>29</sub>H<sub>29</sub>N<sub>5</sub>O<sub>6</sub> 543.57

NA07205

1mg	\$147.00
2mg	\$262.50
5mg	\$504.00

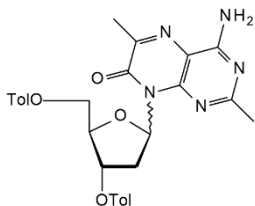
**4-Amino-2,6-dimethyl-8-(2'-deoxy-b-D-ribofuranosyl)-7-pteridone**[195442-56-9] C<sub>13</sub>H<sub>17</sub>N<sub>5</sub>O<sub>4</sub> 307.31

NA06698

1mg	\$89.30
5mg	\$262.50
10mg	\$420.00

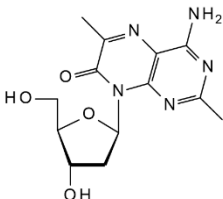

Refs: Hawkins ME, et al, Anal. Biochem. 2001, 298, p231

**N-(2-Amino-3,8-dimethylimidazo[4,5-f]quinoxalin-5-yl)-2'-deoxyguanosine**

see N-(2-Amino-3,8-dimethylimidazo[4,5-f]quinoxalin-5-yl)-2'-deoxyguanosine, NA16594 on page 53

**N-(2-Amino-3,8-dimethylimidazo[4,5-f]quinoxalin-5-yl)-2'-deoxyguanosine**

- N-(2-Amino-3,8-dimethyl-3H-imidazo[4,5-f]quinoxalin-5-yl)-2'-deoxyguanosine
- N2-MelQx-deoxyguanosine

[142038-30-0] C<sub>21</sub>H<sub>22</sub>N<sub>10</sub>O<sub>4</sub> 478.46

NA16594

Price On Application

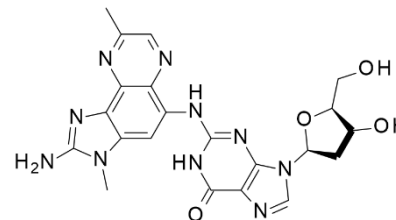

Refs: Farmer, P, et al, Arch. Toxicol, 60, 251 (1987); Chou, H, et al, Cancer Res, 55, 525 (1995); Frantz, C, et al, Carcinogenesis, 16, 367 (1995)

**5-[N-(2-Aminoethyl)-3-E-acrylamido]-2'-deoxy-5'-O-DMT-uridine**C<sub>35</sub>H<sub>38</sub>N<sub>4</sub>O<sub>8</sub> 642.72

NA08231

50mg	\$89.50
100mg	\$168.00
250mg	\$262.50

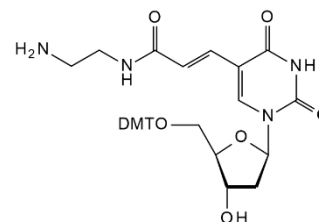
**8-(2-Aminoethyl)aminoadenosine 3',5'-cyclic monophosphate**

• 8-AEA-cAMP

[61363-29-9] C<sub>12</sub>H<sub>18</sub>N<sub>7</sub>O<sub>8</sub>P 387.29

NA09017

1mg	\$94.50
2mg	\$168.00
5mg	\$315.00

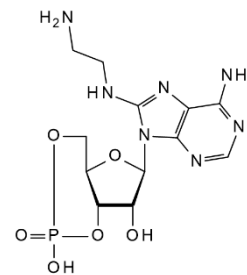

## AminoethylFA

## N6-(2-Aminoethyl)-FAD

see Riboflavin 5'-(trihydrogen diphosphate) P<sup>1</sup>→5'-ester with N-(2-Aminoethyl)adenosine, NR76131 on page 350

## 4-[2-[[6-Amino-9-[N-ethyl-2,3-O-(1-methylethylidene)-b-D-ribofuranuronamidoyl]-9H-purin-2-yl]amino]ethyl]benzenepropanoic acid 1,1-dimethylethyl ester

see 2-[[4-[2-(tert-Butoxycarbonyl)ethyl]phenylethyl]amino]2',3'-O-isopropylideneadenosine-5'-N-ethylcarboxamide, NB16642 on page 129

## 4-[2-[[6-Amino-9-(N-ethyl-b-D-ribofuranuronamidoyl)-9H-purin-2-yl]amino]ethyl]benzenepropanoic acid hydrochloride

see 2-p-(2-Carboxyethyl)phenethylamino-5'-N-ethylcarboxamidoadenosine hydrochloride, NC16650 on page 137

## 4-[2-[[6-Amino-9-(N-ethyl-b-D-ribofuranuronamidoyl)-9H-purin-2-yl]amino]ethyl]benzenepropanoic acid monosodium salt

[120225-64-1] C<sub>23</sub>H<sub>28</sub>N<sub>7</sub>O<sub>6</sub>·Na 521.5

NA10419

5mg \$94.50  
10mg \$157.50  
25mg \$262.50

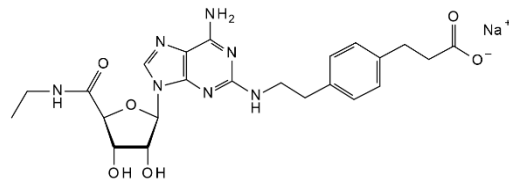

## 4-Amino-1-[(2R,3S,4R,5R)-3-fluoro-4-hydroxy-5-(hydroxymethyl)-oxolan-2-yl]pyrimidin-2-one.HCl

see 1-(2'-Deoxy-2'-fluoro-b-D-arabinofuranosyl)cytosine HCl, ND08343 on page 193

## 4-Amino-5-fluoro-1-[(2S,5R)-2-(hydroxymethyl)-1,3-oxathiolan-5-yl]-2(1H)-pyrimidinone

see (+)-Emtricitabine, NE16704 on page 267

## 5-(4-Amino-5-fluoro-2-oxo-1(2H)-pyrimidinyl)-1,3-oxathiolane-2-carboxylic acid 5-methyl-2-(1-methylethyl)cyclohexyl ester

[147126-75-8] C<sub>18</sub>H<sub>26</sub>FN<sub>3</sub>O<sub>4</sub>S 399.48

NA32529

Price On Application



## 2-Amino-4-(4-fluorophenyl)pyrimidine

• 4-(4-Fluorophenyl)pyrimidin-2-amine

[85979-49-3] C<sub>10</sub>H<sub>8</sub>FN<sub>3</sub> 189.19

NA57405

250mg \$77.50  
500mg \$125.00  
1g \$255.60



## 6-Amino-2-fluoro-9-(b-D-ribofuranosyl)purine

see 2-Fluoroadenosine, NF08852 on page 276

## 4-Amino-5-fluoro-1-[(2S,5R)-tetrahydro-5-(hydroxymethyl)-2-furanyl]-2(1H)-pyrimidinone

see b-L-2',3'-Dideoxy-5-fluorocytidine, ND157001 on page 242

## 8-Aminoguanosine

[3868-32-4] C<sub>10</sub>H<sub>14</sub>N<sub>6</sub>O<sub>5</sub> 298.26

NA04479

100mg \$65.00  
250mg \$110.00  
500mg \$195.00

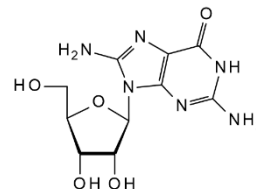

Refs: Kazmers IS, et al, Science 1981, 214, p1137; Chern J-W, et al, J. Med. Chem. 1993, 36, p214

## 5-[N-(6-Aminoethyl)-3-E-acrylamido]-2'-deoxy-5'-O-DMT-uridine

[252337-60-3] C<sub>39</sub>H<sub>46</sub>N<sub>4</sub>O<sub>8</sub> 698.82

NA08232

50mg \$89.50  
100mg \$168.00  
250mg \$395.00

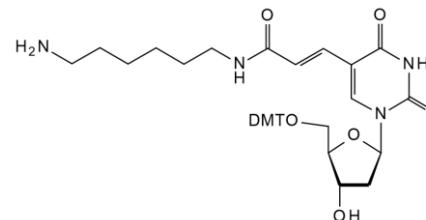

**N6-[[6-Aminoethyl]carbamoylmethyl]adenosine 5'-triphosphate lithium salt**

[98704-19-9]

Price On Application

NA73270

**N6-(6-Aminoethyl)-2'-deoxyadenosine**[147218-60-8] C<sub>18</sub>H<sub>26</sub>N<sub>6</sub>O<sub>3</sub> 350.43

NA09018

25mg	\$100.00
50mg	\$173.50
100mg	\$310.00

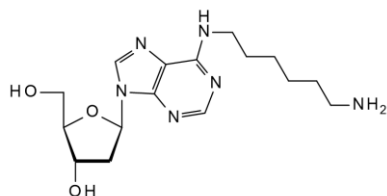
**Aminoethyl-FAD**see *N6-Aminoethyl-flavin adenine dinucleotide*, NA44465 on page 55**N6-Aminoethyl-flavin adenine dinucleotide**

• Aminoethyl-FAD

[76748-73-7] C<sub>32</sub>H<sub>42</sub>N<sub>10</sub>O<sub>15</sub>P<sub>2</sub>·2Na 914.66

Price On Application

NA44465

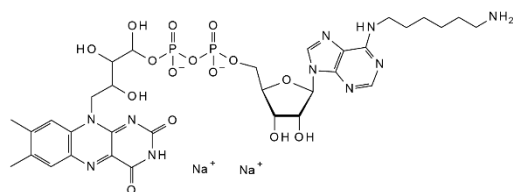
**4-Amino-1-((2R,3R,4R,5R)-3-hydroxy-5-(hydroxymethyl)-4-methoxytetrahydrofuran-2-yl)pyrimidin-2(1H)-one**

NA137508

Price On Application

**2-Amino-9-[4-hydroxy-3-(hydroxymethyl)-2-methylidene-cyclopentyl]-3H-purin-6-one**see *Entecavir hydrate*, NE10532 on page 267**N-[6-[[3-[4-Amino-7-[5-O-[hydroxy[[hydroxy(phosphonoxy)phosphinyl]oxy]phosphinyl]-b-D-ribofuranosyl]-7H-pyrrolo[2,3-d]pyrimidin-5-yl]-2-propynyl]amino]-6-oxohexyl]-3',6'-dihydroxy-3-oxospiro[isobenzofuran-1(3H),9'-[9H]xanthen]-ar-carboxamide**see *Fluorescein alkynylamino-ATP - 1.0 mM solution*, NF16725 on page 275**4-Amino-6-hydroxy-2-mercapto-5-nitropyrimidine ammonium salt**

• 6-Amino-5-nitroso-2-thiouracil ammonium salt

[5451-33-2] C<sub>4</sub>H<sub>7</sub>N<sub>5</sub>O<sub>2</sub>S 189.2

NA70525

25mg	\$55.00
50mg	\$85.00
100mg	\$130.00

**4-Amino-1-((2S,4S)-2-(hydroxymethyl)-1,3-dioxolan-4-yl)pyrimidin-2(1H)-one**see *Troxacitabine*, NT29825 on page 378**4-Amino-1-[(2R,5R)-2-(hydroxymethyl)-1,3-oxathiolan-5-yl]-2(1H)-pyrimidinone**see *5'-Epi lamivudine*, NE22708 on page 269**4-Amino-1-[(2S,5R)-2-(hydroxymethyl)-1,3-oxathiolan-5-yl]-2(1H)-pyrimidinone**see *ent-Lamivudine*, NE22686 on page 268

## Aminohydroxy

## 4-Amino-1-[(2S,5S)-2-(hydroxymethyl)-1,3-oxathiolan-5-yl]-2(1H)-pyrimidinone

see 2'-Epi-lamivudine, NE22731 on page 268

## (2R-trans)-4-Amino-1-[2-(hydroxymethyl)-1,3-oxathiolan-5-yl]-2(1H)-pyrimidinone

see 5'-Epi lamivudine, NE22708 on page 269

## (2S-cis)-4-Amino-1-[2-(hydroxymethyl)-1,3-oxathiolan-5-yl]-2(1H)-pyrimidinone

see ent-Lamivudine, NE22686 on page 268

## (2S-trans)-4-Amino-1-[2-(hydroxymethyl)-1,3-oxathiolan-5-yl]-2(1H)-pyrimidinone

see 2'-Epi-lamivudine, NE22731 on page 268

## 4-Amino-6-hydroxy-2-methylpyrimidine

[767-16-8] 125.13

NA44281

5g	\$76.30
10g	\$122.00
25g	\$195.50

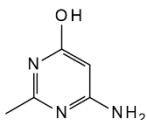

## 2-Amino-6-[(2-hydroxy-5-nitrobenzyl)thio]-9-(β-D-ribofuranosyl)purine

see S-(2-Hydroxy-5-nitrobenzyl)-6-thioguanosine, NH08019 on page 290

## 4-Amino-6-hydroxypyrazolo(3,4-D)pyrimidine

[5472-41-3] C<sub>5</sub>H<sub>5</sub>N<sub>5</sub>O 151.13

NA65977

Price On Application



## 2-Amino-4-hydroxy-6-(trifluoromethyl)pyrimidine

[1513-69-5]

NA44301

Price On Application

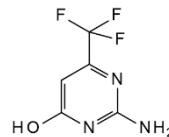

## 5-Aminoimidazole-4-carboxamide-1-β-D-ribofuranose 5'-monophosphate

• AICAR monophosphate

[3031-94-5] C<sub>9</sub>H<sub>15</sub>N<sub>4</sub>O<sub>8</sub>P 338.21

NA07204

5mg	\$63.00
10mg	\$94.50
25mg	\$184.00

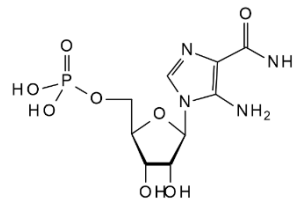

## 5-Aminoimidazole-4-carboxamide-1-β-D-ribofuranose

- Acadesine
- N1-(β-D-Ribofuranosyl)-5-aminoimidazole-4-carboxamide
- AICAR

[2627-69-2] C<sub>9</sub>H<sub>14</sub>N<sub>4</sub>O<sub>5</sub> 258.23

NA03552

250mg	\$50.00
500mg	\$80.00
1g	\$138.00

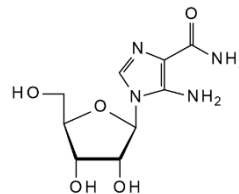

Refs: Mullane K, et al, Trends Cardiovasc. Med. 1993, 3, p227; Brown GJ, et al, J. Biol. Chem. 2004, 279, 13, p12220; Fediciu, et.al, Endocrinology, 2006, 147, p5170; Prasad, et.al, J. Neurosci. Res, 2006, 84, p614

## 5-Aminoimidazole-4-carboxamide-1-β-D-ribofuranosyl 3':5'-cyclic-monophosphate

see AICAR 3',5'-cyclic phosphate, NA16501 on page 30

**5-Aminoimidazole-4-carboxamide-1-β-D-ribofuranosyl 5'-triphosphate**

• AICAR Triphosphate

[82989-82-0] C<sub>9</sub>H<sub>17</sub>N<sub>4</sub>O<sub>14</sub>P<sub>3</sub> 498.17

NA01454

Price On Application

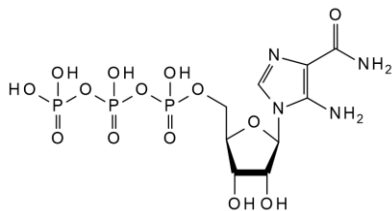
**1-(6-Amino-2-iodo-9H-purin-9-yl)-1-deoxy-N-ethyl-2,3-O-(1-methylethylidene)-β-D-ribofuranuronamide**

see 5'-Ethylcarboxamido-2-iodo-2',3'-O-isopropylideneadenosine, NE03797 on page 271

**6-Amino-2-iodo-9-(β-D-ribofuranosyl)purine**

see 2-Iodoadenosine, NI04749 on page 293

**6-Amino-4-keto-2-methylmercaptopyrimidine**

see 2-Methylmercapto-4-oxo-6-aminopyrimidine monohydrate, NM70420 on page 320

**2-Amino-6-mercapto-7-methylpurine ribonucleoside**

see 7-Methyl-6-thioguanosine inner salt, NM06560 on page 325

**2-Amino-6-mercapto-9-(β-D-ribofuranosyl)purine**

see 6-Thioguanosine, NT04480 on page 360

**2-Amino-6-mercapto-9-(2',3',5'-tri-O-acetyl-β-D-ribofuranosyl)purine**• 2-Amino-9-(2,3,5-tri-O-acetyl-β-D-ribofuranosyl)-6-thiopurine  
• 2',3',5'-Tri-O-acetyl-6-mercaptoguanosine[2946-36-3] C<sub>16</sub>H<sub>19</sub>N<sub>5</sub>O<sub>7</sub>S 425.42

NA06751

500mg	\$155.00
1g	\$250.00
2g	\$350.00

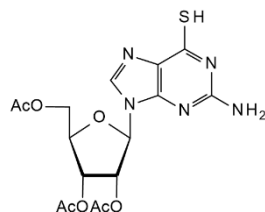
**2-Amino-4-methoxy-7-(2-deoxy-β-D-ribofuranosyl)-pyrrolo[2,3-d]pyrimidine**[150206-15-8] C<sub>12</sub>H<sub>16</sub>N<sub>4</sub>O<sub>4</sub> 280.28

NA06393

25mg	\$95.00
50mg	\$160.00
100mg	\$250.00

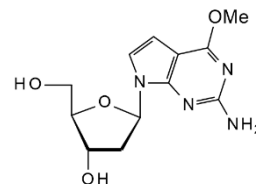
**3-[a-Amino-p-methoxyhydrocinnamido]-3'-deoxy-N,N-dimethyladenosine dihydrochloride**

see Puromycin dihydrochloride, NP09203 on page 346

**4-Amino-1-[(2R,5S)-5-[[bis(4-methoxyphenyl)phenylmethoxy]methyl]tetrahydro-2-furanyl]-2(1H)-pyrimidinone**

see 2',3'-Dideoxy-5'-O-DMT-cytidine, ND08403 on page 241

**2-Amino-4-(4-methoxyphenyl)pyrimidine**

• 4-(4-Methoxyphenyl)pyrimidin-2-amine

[99844-02-7] 201.22

NA57406

500mg	\$95.00
1g	\$225.60
2g	\$360.90

**2-Amino-4-methoxypyrimidine**

[155-90-8]

NA44306

Price On Application

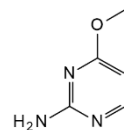

## Aminomethoxy

## 4-Amino-2-methoxypyrimidine

• 2-Methoxy-pyrimidin-4-ylamine

[3289-47-2] 125.13

NA57396

1g	\$87.60
2g	\$197.70
5g	\$316.30



## 2-Amino-2'-O-methyladenosine

[80791-87-3] C<sub>11</sub>H<sub>16</sub>N<sub>6</sub>O<sub>4</sub> 296.28

NA06394

250mg	\$52.50
1g	\$157.50
2g	\$315.00

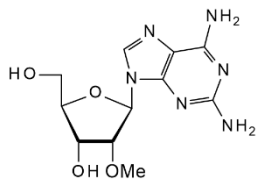

## 4-Amino-6-methyl-8-(2'-deoxy-b-D-ribofuranosyl)-7-pteridone

[195442-55-8] C<sub>12</sub>H<sub>15</sub>N<sub>5</sub>O<sub>4</sub> 293.28

NA04481

1mg	\$89.30
5mg	\$189.00
10mg	\$315.00

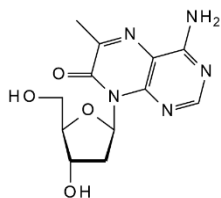

Refs: Hawkins ME, et al, Anal. Biochem. 2001, 298, p231



## 8-(2-Amino-1-methyl-6-phenylimidazo[4,5-b]pyridyl)-2'-deoxyguanosine

• N-(Deoxyguanosin-8-yl)-2-amino-1-methyl-6-phenylimidazo[4,5-b]pyridine

[142784-25-6] C<sub>23</sub>H<sub>23</sub>N<sub>9</sub>O<sub>4</sub> 489.49

NA04649

1mg	\$950.00
2mg	\$1750.00
5mg	\$3250.00

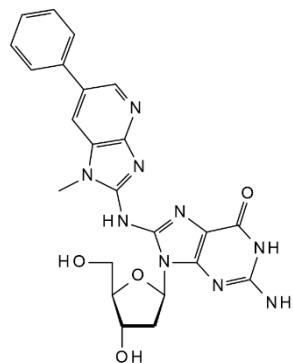

Refs: Frandsen, H, et al, Carcinogenesis 1992 13, 4, p629; Lin D, et al, Chem. Res. Toxicol. 1993 5 p691



## 8-(2-Amino-1-methyl-D3-6-phenylimidazo[4,5-b]pyridyl)-2'-deoxyguanosine

• N-(Deoxyguanosin-8-yl)-2-amino-1-methyl-D3-6-phenylimidazo[4,5-b]pyridine

[303173-39-9] C<sub>23</sub>H<sub>20</sub>D<sub>3</sub>N<sub>9</sub>O<sub>4</sub> 492.5

NA05715

500ug \$4620.00

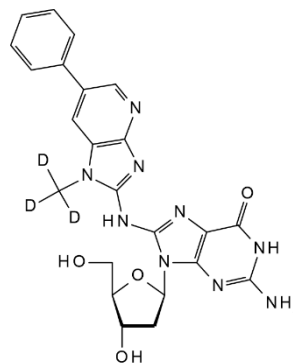

Refs: Frandsen H, et al, Carcinogenesis 1992, 13, 4, p629



**2-Amino-6-(4-methylphenyl)thio-9-(2',3',5'-tri-O-acetyl-b-D-ribofuranosyl)purine**[135041-23-5] C<sub>23</sub>H<sub>25</sub>N<sub>5</sub>O<sub>7</sub>S 515.54

NA10196

250mg	\$105.00
500mg	\$160.00
1g	\$262.50

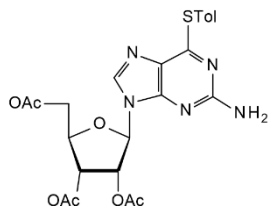
**2-(Aminomethyl)pyrimidine oxalate**

• Pyrimidin-2-ylmethanamine oxalate

[866625-10-7] C<sub>5</sub>H<sub>7</sub>N<sub>3</sub>·C<sub>2</sub>H<sub>2</sub>O<sub>4</sub> 199.16

NA57383

50mg	\$81.00
100mg	\$130.00
250mg	\$162.50

**6-Amino-4-methyl-8-(b-D-ribofuranosyl)-4H,8H-pyrrolo[4,3,2-de]pyrimido[4,5-c]pyridazine 5'-monophosphate**see *Tricyclic nucleoside phosphate, NT44794 on page 375***6-Amino-4-methyl-8-(b-D-ribofuranosyl)-4H,8H-pyrrolo[4,3,2-de]pyrimido[4,5-c]pyridazine**see *Triciribine, NT08796 on page 375***4-Amino-7-(2-C-methyl-b-D-ribofuranosyl)-7H-pyrrolo[2,3-d]pyrimidine-5-carboxylic acid**[443642-56-6] C<sub>13</sub>H<sub>16</sub>N<sub>4</sub>O<sub>6</sub> 324.29

NA14089

Price On Application

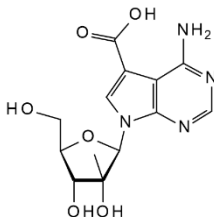
**6-Amino-1-methyluracil**

[2434-53-9]

NA03107

Price On Application



Refs: Yavolovskii A A, Ivanov E I, RUSSIAN JOURNAL OF GENERAL CHEMISTRY 2001, 71, p1828

**4-Amino-3-(1-naphthylmethyl)-1H-pyrazolo[3,4-d]pyrimidine-1-(b-D-ribofuranosyl-5'-triphosphate)**

- 1-[5-O-[Hydroxy[[hydroxy(phosphonoxy)phosphinyl]oxy]phosphinyl]-b-D-ribofuranosyl]-3-(1-naphthalenylmethyl)-1H-pyrazolo[3,4-d]pyrimidine-4-amine
- 3-(1-NM)-PPTP

[476371-81-0] C<sub>21</sub>H<sub>24</sub>N<sub>5</sub>O<sub>13</sub>P<sub>3</sub> 647.36

NA16506

1mg	\$530.90
2mg	\$965.30
5mg	\$1755.00

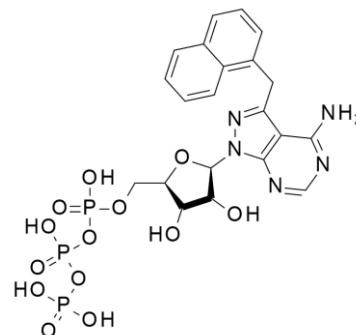

Refs: Hunter, T, et al, Cell, 80, 225 (1995)

**2-Amino-6-[(4-nitrobenzyl)thio]-9-b-D-ribofuranosylpurine**see *S-(4-Nitrobenzyl)-6-thioguanosine, NN09411 on page 335***6-Amino-5-nitro-3-(2'-deoxy-b-D-ribofuranosyl)-2(1H)-pyridone**[642460-95-5] C<sub>10</sub>H<sub>13</sub>N<sub>3</sub>O<sub>6</sub> 271.23

NA145592

50mg	\$275.00
100mg	\$450.00
250mg	\$975.00



## Aminonitroso

## 6-Amino-5-nitroso-2-thiouracil ammonium salt

see 4-Amino-6-hydroxy-2-mercapto-5-nitrosopyrimidine ammonium salt, NA70525 on page 55

## (E)-((2R,3R,5R)-5-(4-Amino-2-oxypyrimidin-1(2H)-yl)-4,4-difluoro-3-hydroxytetrahydrofuran-2-yl)methyl octadec-9-enoate

see Gemcitabine 5'-elaidate, NC05399 on page 281

## cis-5-(4-Amino-2-oxo-1(2H)-pyrimidinyl)-1,3-oxathiolane-2-carboxylic acid

see rac-Lamivudine acid, NL27534 on page 301

## (2R-cis)-5-(4-Amino-2-oxo-1(2H)-pyrimidinyl)-1,3-oxathiolane-2-carboxylic acid

see Lamivudine acid, NL34824 on page 301

## P-[[[(2R,5S)-5-(4-Amino-2-oxo-1(2H)-pyrimidinyl)-1,3-oxathiolan-2-yl]methyl] ester diphosphoric acid ammonium salt

see Lamivudine 5'-diphosphate ammonium salt, NL24830 on page 301

## 2-Aminoperimidine hydrochloride

[29416-86-2] C<sub>11</sub>H<sub>10</sub>ClN<sub>3</sub> 219.67

NA68095	1g	\$40.00
	2g	\$76.00
	5g	\$180.00



## 8-(4-Aminophenyl)-2'-deoxyguanosine

C<sub>16</sub>H<sub>18</sub>N<sub>6</sub>O<sub>4</sub> 358.35

NA04648	25mg	\$1500.00
	50mg	\$2400.00
	100mg	\$3120.00

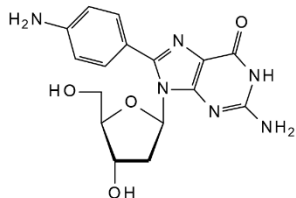

## N6-2-(4-Aminophenyl)ethyladenosine

• Apnea

[89705-21-5]

NA72432

Price On Application



## 5'-(4-Aminophenylphosphoryl)uridine-2'(3')-phosphate

NA106323

Price On Application



## 2-Amino-4-phenylpyrimidine

• 4-Phenyl-2-pyrimidinamine

[2305-87-5] 171.2

NA57402	2g	\$82.00
	5g	\$213.90
	10g	\$342.20



## 2-Amino-4-phenyl-6-(trifluoromethyl)pyrimidine

• 4-phenyl-6-(trifluoromethyl)-2-Pyrimidinamine

[26974-09-4] C<sub>11</sub>H<sub>8</sub>F<sub>3</sub>N<sub>3</sub> 239.2

NA57415	500mg	\$75.00
	1g	\$134.80
	2g	\$215.70



## 5-Amino-1-(3,5-O-phosphinico-b-D-ribofuranosyl)-1H-imidazole-4-carboxamide

see AICAR 3',5'-cyclic phosphate, NA16501 on page 30



**4-Amino-1-[(2R,5S)-2-[(phosphonoxy)methyl]-1,3-oxathiolan-5-yl]-2(1H)-pyrimidinone ammonium salt**see *Lamivudine 5'-monophosphate ammonium salt, NL24831 on page 302***4-Amino-1-[(2R,5S)-2-[(phosphonoxy)methyl]-1,3-oxathiolan-5-yl]-2(1H)-pyrimidinone sodium salt**see *Lamivudine 5'-monophosphate sodium salt, NL28880 on page 302***6-Aminopurine-2'-fluoro-2'-deoxyarabinfuranoside**see *9-(2'-Deoxy-2'-fluoro-b-D-arabinofuranosyl)adenine, ND09204 on page 192***2-Aminopurine riboside**see *2-Amino-9-(b-D-ribofuranosyl)purine, NA04488 on page 62***1-(6-Amino-9H-purin-9-yl)-1-deoxy-N-ethyl-b-D-ribofuranuronamide**see *5'-Ethylcarboxamidoadenosine, NE06155 on page 270***[(2S,5R)-5-(6-Amino-9H-purin-9-yl)-2,5-dihydrofuran-2-yl]methanol**see *2',3'-Dideoxy-2',3'-dideoxyadenosine, ND05186 on page 241***1-[2-(6-Aminopurin-9-yl)-3,4-dihydroxy-5-(hydroxymethyl)pyrrolidin-1-yl]ethanone**

• 4'-Acetamido-4'-deoxyadenosine

[14062-45-4] C<sub>12</sub>H<sub>16</sub>N<sub>6</sub>O<sub>4</sub> 308.29

NA71841

Price On Application

**[(2S,4S,5R)-5-(6-Aminopurin-9-yl)-4-fluorooxolan-2-yl]methanol**see *6-Amino-9-(2',3'-dideoxy-2'-fluoro-b-D-arabinofuranosyl)purine, NA05179 on page 51***[(2S,5R)-5-(6-Amino-9H-purin-9-yl)tetrahydro-2-furanyl]methyl dihydrogen phosphate**see *2',3'-Dideoxyadenosine-5'-monophosphate, ND30902 on page 239***2-Aminopyrimidine-5-boronic acid**

• 2-Amino-5-boropyrimidine

[936250-22-5] C<sub>4</sub>H<sub>6</sub>BN<sub>3</sub>O<sub>2</sub> 138.92

NA57424

250mg	\$85.00
500mg	\$135.00
1g	\$381.90

**4-Amino-5-pyrimidinecarboxylic acid**see *4-Aminopyrimidine-5-carboxylic acid, NA57368 on page 61***4-Aminopyrimidine-5-carboxylic acid**

• 4-Amino-5-pyrimidinecarboxylic acid

[20737-41-1] 139.11

NA57368

500mg	\$60.00
1g	\$97.50
2g	\$156.00

**2-Amino-5-pyrimidinesulfonamide**

• 2-Amino-pyrimidine-5-sulfonic acid amide

[99171-23-0] C<sub>4</sub>H<sub>6</sub>N<sub>4</sub>O<sub>2</sub>S 174.18

NA57372

100mg	\$93.00
250mg	\$120.00
500mg	\$190.00

**2-Amino-pyrimidine-5-sulfonic acid amide**see *2-Amino-5-pyrimidinesulfonamide, NA57372 on page 61*

## Aminopyrrolo

## 4-Amino-7H-pyrrolo[2,3-d]pyrimidine hydrogen sulfate

[769951-32-8]

NA44317

Price On Application

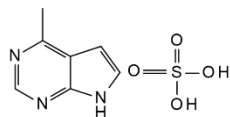

## 2-Amino-8-D-ribofuranosyl-imidazol[1,2-a]-1,3,5-triazin-4(8H)-one

see 5-Aza-7-deazaguanosine, NA09785 on page 77

## N-[(5-Amino-1-b-D-ribofuranosyl-1H-imidazol-4-yl)carbonyl]-L-aspartic acid

see N-Succinyl-5-aminoimidazole-4-carboxamide ribose disodium salt, NS16860 on page 354

## N-[(5-Amino-1-b-D-ribofuranosylimidazol-4-yl)carbonyl]-L-aspartic acid

see N-Succinyl-5-aminoimidazole-4-carboxamide ribose 5'-phosphate dibarium salt, NS45131 on page 354

## 4-Amino-1-(b-D-ribofuranosyl)-1H-imidazo[4,5-d]pyridine

see 3-Deazaadenosine, ND04697 on page 164

## 2-Amino-9-(b-D-ribofuranosyl)purine 5'-O-triphosphate - 10mM aq. solution

[23001-60-7]

C<sub>10</sub>H<sub>16</sub>N<sub>5</sub>O<sub>13</sub>P<sub>3</sub> 507.18

NA46037

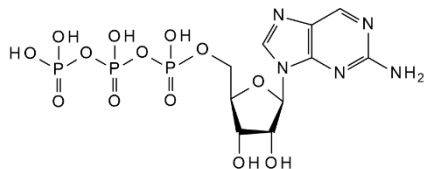
2.5mg  
5mg\$475.00  
\$825.00

## 2-Amino-9-(b-D-ribofuranosyl)purine

• 2-Aminopurine riboside

[4546-54-7] C<sub>10</sub>H<sub>13</sub>N<sub>5</sub>O<sub>4</sub> 267.24

NA04488

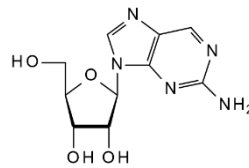
50mg \$79.00  
100mg \$132.00  
250mg \$245.00

Refs: O'Neill M, Barton JK, J. Am. Soc. 2002, 124, p13053



## 2-Amino-1-b-D-ribofuranosyl-4(1H)-pyrimidinone

see Isocytidine, NI24672 on page 298

## 2-Amino-7-b-D-ribofuranosyl[3,2-d]pyrimidin-4-one

see 7-Deazaguanosine, ND05752 on page 168

## 2-Amino-7-b-D-ribofuranosyl[3,2-d]pyrimidin-4-one

see 9-Deazaguanosine, ND06109 on page 168

## 4-Amino-7-b-D-ribofuranosyl-7H-pyrrolo[2,3-d]pyrimidine

see 7-Deazaadenosine, ND06290 on page 164

## 2-Amino-4-(thien-2-yl)pyrimidine

• 4-(Thiophen-2-yl)pyrimidin-2-amine

[154321-60-5] 177.23

NA57407

500mg \$80.00  
1g \$209.40  
2g \$335.00

## 3'-O-Aminothymidine-5'-triphosphate

[1159990-37-0]

NA145309

Price On Application



**3'-Amino-D-thymidine**

see 3'-Amino-3'-deoxythymidine, NA02831 on page 49

**3'-O-Aminothymidine**[103251-38-3] C<sub>10</sub>H<sub>15</sub>N<sub>5</sub>O<sub>5</sub> 257.24

NA145308

Price On Application

**5-Amino-1-(2',3',5'-tri-O-acetyl-b-D-ribofuranosyl)-imidazole-4-carbonitrile**[23192-63-4] C<sub>15</sub>H<sub>18</sub>N<sub>4</sub>O<sub>7</sub> 366.33

NA11708

1mg	\$84.00
2mg	\$157.50
5mg	\$262.50

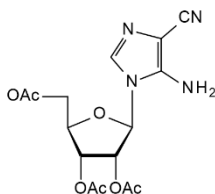
**5-Amino-1-(2',3',5'-tri-O-acetyl-b-D-ribofuranosyl)-imidazole-4-carboxamide**[23274-21-7] C<sub>15</sub>H<sub>20</sub>N<sub>4</sub>O<sub>8</sub> 384.34

NA11364

1mg	\$84.00
2mg	\$157.50
5mg	\$262.50

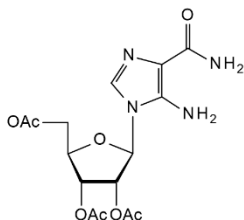
**2-Amino-9-(2',3',5'-tri-O-acetyl-b-D-ribofuranosyl)purine**C<sub>18</sub>H<sub>19</sub>N<sub>5</sub>O<sub>7</sub> 393.35

NA08320

100mg	\$105.00
250mg	\$210.00
500mg	\$370.00

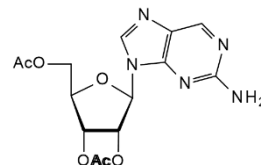
**2-Amino-9-(2,3,5-tri-O-acetyl-b-D-ribofuranosyl)-6-thiopurine**

see 2-Amino-6-mercapto-9-(2',3',5'-tri-O-acetyl-b-ribofuranosyl)purine, NA06751 on page 57

**6-Amino-9-(2',3',5'-tri-O-benzoyl-2'-C-methyl-b-D-ribofuranosyl)purine**C<sub>32</sub>H<sub>27</sub>N<sub>5</sub>O<sub>7</sub> 593.6

NA08395

500mg	\$3675.00
1g	\$5250.00

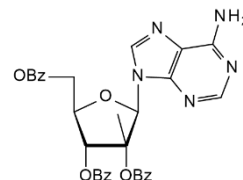
**4-Amino-1-(2',3',5'-tri-O-tert-butyl dimethylsilyl-b-D-ribofuranosyl)-imidazo[4,5-c]pyridine**[147212-86-0] C<sub>29</sub>H<sub>56</sub>N<sub>4</sub>O<sub>4</sub>Si<sub>3</sub> 609.04

NA04493

5mg	\$315.00
10mg	\$577.50
25mg	\$892.50

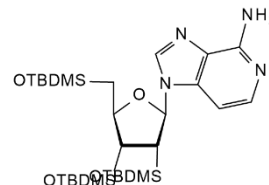

**Aminouridine****5-Aminouridine hydrochloride**[116154-74-6] C<sub>9</sub>H<sub>14</sub>ClN<sub>3</sub>O<sub>6</sub> 295.68

NA17376	50mg	\$125.00
	100mg	\$225.00
	250mg	\$410.00

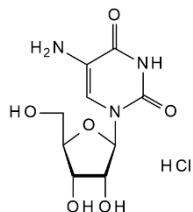

Refs: Roberts, M. and Visser, D.W, J. Biol. Chem, 194, 695 (1952); Beltz, R.E, et al, J. Biol. Chem, 226, 1035 (1957)

**Ammonium 4-nitrobenzoate dihydrate**

[19416-70-7]

NA30959

Price On Application

**5'-AMP·H<sub>2</sub>O Adenosine-5'-monophosphoric acid monohydrate/5'-Adenylic acid**see *Adenosine 5'-monophosphate monohydrate*, NA30567 on page 24**3'-AMP**see *Adenosine-3'-monophosphate*, NA66252 on page 25**2',3'-Anhydroadenosine**

NA145605	10mg	\$50.00
	25mg	\$115.00
	50mg	\$210.00

**2,3'-Anhydro-5'-O-p-anisoyl-N4-benzoyl-2'-deoxycytidine**C<sub>24</sub>H<sub>23</sub>N<sub>3</sub>O<sub>6</sub> 449.46

NA09230

Price On Application

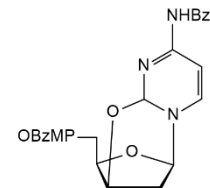
**2,3'-Anhydro-5'-O-p-anisoylthymidine**C<sub>18</sub>H<sub>20</sub>N<sub>2</sub>O<sub>6</sub> 360.36

NA09231

Price On Application

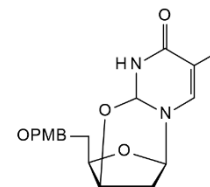
**2,2'-Anhydro-b-D-arabinofuranosyl cytosine HCl**see *2,2'-Anhydrocytidine HCl*, NA01967 on page 67**2,2'-Anhydro-b-D-arabinofuranosyl cytosine**see *2,2'-Anhydrocytidine*, NA02790 on page 67**2,2'-Anhydro-(1-b-D-arabinofuranosyl)-5-methyluracil**see *2,2'-Anhydrothymidine*, NA06711 on page 68**2,2'-Anhydro-b-D-arabinofuranosyl uracil**see *2,2'-Anhydrouridine*, NA05939 on page 69

**2,3'-Anhydro-5'-O-benzoyl-N4-benzoyl-2'-deoxycytidine**C<sub>23</sub>H<sub>21</sub>N<sub>3</sub>O<sub>5</sub> 419.44

NA09232

Price On Application

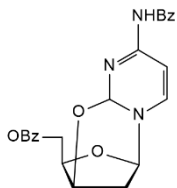
**1,5-Anhydro-3-O-benzoyl-4,6-O-benzylidene-2-deoxy-2-(N6-benzoyladenin-1-yl)-D-alto-hexitol**C<sub>32</sub>H<sub>27</sub>N<sub>5</sub>O<sub>6</sub> 577.6

NA07164

100mg	\$263.00
200mg	\$462.00
500mg	\$945.00

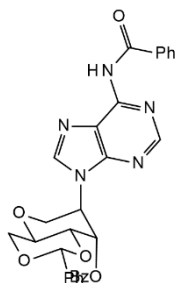
**1,5-Anhydro-3-O-benzoyl-4,6-O-benzylidene-2-deoxy-2-(N4-benzoylcytidin-1-yl)-D-alto-hexitol**C<sub>24</sub>H<sub>22</sub>N<sub>2</sub>O<sub>7</sub> 450.45

NA07163

100mg	\$263.00
200mg	\$462.00
500mg	\$945.00

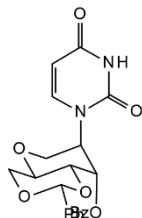
**1,5-Anhydro-3-O-benzoyl-4,6-O-benzylidene-2-deoxy-2-(N8-(dimethylamino)methyleneguanidin-1-yl)-D-alto-hexitol**C<sub>28</sub>H<sub>28</sub>N<sub>6</sub>O<sub>6</sub> 544.57

NA07165

25mg	\$95.00
50mg	\$150.00
100mg	\$275.00

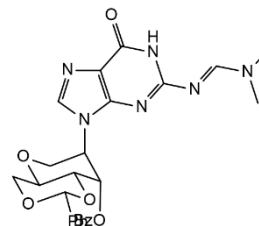
**1,5-Anhydro-3-O-benzoyl-4,6-O-benzylidene-2-deoxy-2-(uracil-1-yl)-D-alto-hexitol**C<sub>24</sub>H<sub>22</sub>N<sub>2</sub>O<sub>7</sub> 450.45

NA07162

100mg	\$263.00
200mg	\$462.00
500mg	\$945.00

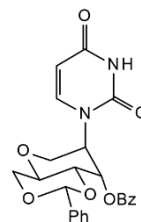
**2,3'-Anhydro-N4-benzoyl-2'-deoxy-5'-O-DMT-cytidine**

NA145740

100mg	\$50.00
250mg	\$115.00
500mg	\$205.00



## Anhydrobenzo

## 2,3'-Anhydro-5'-O-benzoylthymidine

C<sub>17</sub>H<sub>18</sub>N<sub>2</sub>O<sub>5</sub> 330.34

NA09233

Price On Application

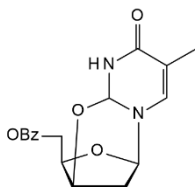

## 1,5-Anhydro-4,6-O-benzylidene-2,3-dideoxy-2-(N6-benzoyladenin-1-yl)-D-glucitol

C<sub>25</sub>H<sub>23</sub>N<sub>5</sub>O<sub>4</sub> 457.49

NA07921

Price On Application

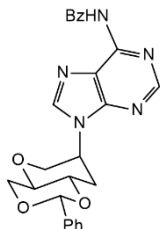

## 1,5-Anhydro-4,6-O-benzylidene-2,3-dideoxy-2-(N2-isobutyrylguanidin-1-yl)-D-glucitol

C<sub>22</sub>H<sub>25</sub>N<sub>5</sub>O<sub>5</sub> 439.48

NA07923

Price On Application

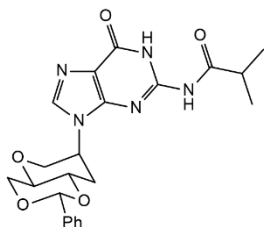

## 1,5-Anhydro-4,6-O-benzylidene-2,3-dideoxy-2-[uracil-1-yl]-D-glucitol

[852235-06-4] C<sub>17</sub>H<sub>18</sub>N<sub>2</sub>O<sub>5</sub> 330.34

NA04723

5g

\$3360.00

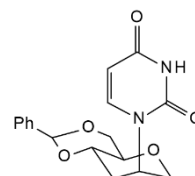

## 2,3'-Anhydro-5'-O-tert-butylidimethylsilyl-N4-benzoyl-2'-deoxycytidine

C<sub>22</sub>H<sub>31</sub>N<sub>3</sub>O<sub>4</sub>Si 429.6

NA09234

Price On Application

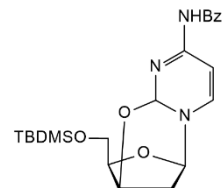

## 2,3'-Anhydro-5'-O-tert-butylidimethylsilylthymidine

C<sub>18</sub>H<sub>28</sub>N<sub>2</sub>O<sub>5</sub>Si 356.5

NA09235

Price On Application

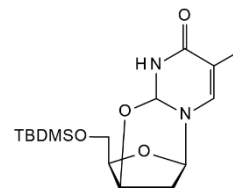

## 2,3'-Anhydro-5'-O-tert-butylidiphenylsilylthymidine

NA145608

500mg	\$50.00
1g	\$90.00
2g	\$164.00



**2,2'-Anhydrocytidine HCl**

- 2,2'-Anhydro-b-D-arabinofuranosyl cytosine HCl
- Cyclocytidine HCl

[10212-25-6] C<sub>9</sub>H<sub>11</sub>N<sub>3</sub>O<sub>4</sub>·HCl 261.66

NA01967	2g	\$70.00
	5g	\$125.00
	10g	\$210.00

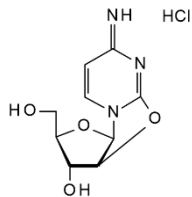
**2,2'-Anhydrocytidine**

- 2,2'-Anhydro-b-D-arabinofuranosyl cytosine

[31698-14-3] C<sub>9</sub>H<sub>11</sub>N<sub>3</sub>O<sub>4</sub> 225.2

NA02790	2g	\$157.50
	5g	\$262.50
	10g	\$420.00

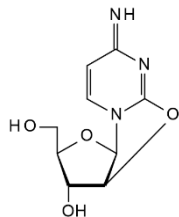
**2,3'-Anhydro-2'-deoxyadenosine**C<sub>10</sub>H<sub>11</sub>N<sub>5</sub>O<sub>3</sub> 249.23

NA08319

Price On Application

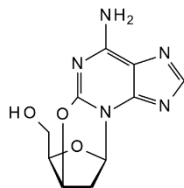
**2,5'-Anhydro-5,6-didehydro-2'-deoxy-2',2'-difluorouridine**C<sub>9</sub>H<sub>10</sub>F<sub>2</sub>N<sub>2</sub>O<sub>5</sub> 264.18

NA71416

Price On Application

**1,5-Anhydro-2,3-dideoxy-2-(N6-benzoyladenine-1-yl)-D-glucitol**C<sub>19</sub>H<sub>19</sub>N<sub>5</sub>O<sub>4</sub> 369.38

NA07922

Price On Application

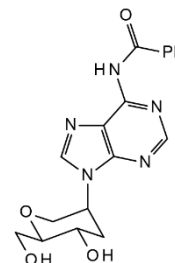
**1,5-Anhydro-2,3-dideoxy-2-(N2-isobutyrylguanidine-1-yl)-D-glucitol**C<sub>15</sub>H<sub>21</sub>N<sub>5</sub>O<sub>5</sub> 351.37

NA07924

Price On Application

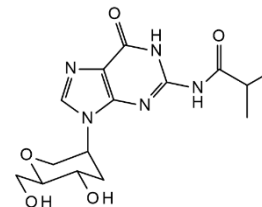
**2,2'-Anhydro-5'-O-DMT-thymidine**

NA145607

500mg	\$50.00
1g	\$90.00
2g	\$164.00



## Anhydrofruct

**2,3'-Anhydro-1-b-D-fructofuranosyluracil**[55697-38-6] C<sub>10</sub>H<sub>12</sub>N<sub>2</sub>O<sub>6</sub> 256.21

NA31000

Price On Application

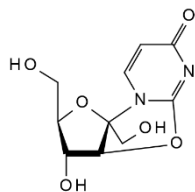
**O2-3'-anhydro-beta-D-fructofuranosyluracil**

NO30948

Price On Application

**2',3'-Anhydroinosine**

• 9-(2,3-Anhydro-b-D-ribofuranosyl)-1,9-dihydro-6H-purin-6-one

[31766-13-9] C<sub>10</sub>H<sub>10</sub>N<sub>4</sub>O<sub>4</sub> 250.21

NA17929

10mg	\$157.50
25mg	\$257.50
50mg	\$367.50

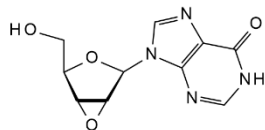

Refs: Rao, D.V.N. et al, J. Pharmac. Biomed.Anal, 45, 516 (2007)

**2,2'-Anhydro-6-methoxycarbonyl-b-D-arabinofuranosyl uracil**[36963-58-3] C<sub>11</sub>H<sub>12</sub>N<sub>2</sub>O<sub>7</sub> 284.22

NA00714

Price On Application

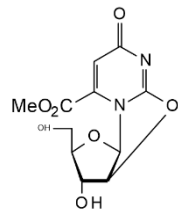
**2,2'-Anhydro-5-methyl-D-uridine**

see 2,2'-Anhydrothymidine, NA06711 on page 68

**9-(2,3-Anhydro-b-D-ribofuranosyl)-1,9-dihydro-6H-purin-6-one**

see 2',3'-Anhydroinosine, NA17929 on page 68

**2,3'-Anhydrothymidine, methyl-D3**C<sub>10</sub>H<sub>9</sub>D<sub>3</sub>N<sub>2</sub>O<sub>4</sub> 227.23

NA06320

1mg	\$241.50
2mg	\$420.00
5mg	\$787.50

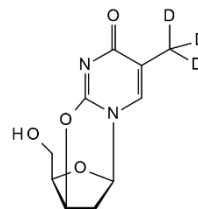
**2,2'-Anhydro-L-thymidine**[433733-92-7] C<sub>10</sub>H<sub>12</sub>N<sub>2</sub>O<sub>5</sub> 240.21

NA07017

5g	\$1050.00
10g	\$1750.00
25g	\$2875.00

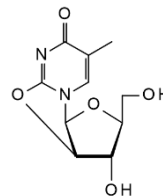
**2,2'-Anhydrothymidine**

- 2,2'-Anhydro-5-methyl-D-uridine
- 2,2'-Anhydro-(1-b-D-arabinofuranosyl)-5-methyluracil

[22423-26-3] C<sub>10</sub>H<sub>12</sub>N<sub>2</sub>O<sub>5</sub> 240.21

NA06711

50g	\$90.00
100g	\$150.00
250g	\$250.00

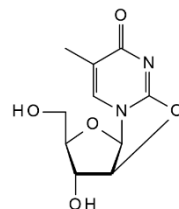

Refs: Codington JF, et.al, J. Org. Chem, 1964, 29, p558



**2,5'-Anhydro-thymidine**[38313-48-3] C<sub>10</sub>H<sub>12</sub>N<sub>2</sub>O<sub>4</sub> 224.21

NA02980

Price On Application

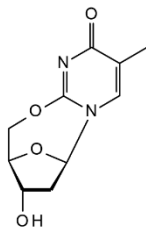
**2,2'-Anhydro-5'-O-toluoyluridine**C<sub>17</sub>H<sub>16</sub>N<sub>2</sub>O<sub>6</sub> 344.32

NA08256

Price On Application

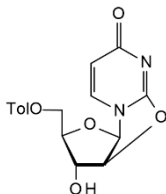
**2,3'-Anhydro-5'-O-tritylthymidine**C<sub>29</sub>H<sub>26</sub>N<sub>2</sub>O<sub>4</sub> 466.53

NA06305

50mg	\$89.50
100mg	\$158.00
250mg	\$290.00

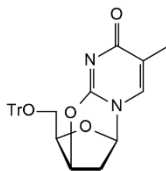

Refs: Vrang L, Bazin H, Remaud G, Chattopadhyaya J, Oberg B, Antiviral Res. 1987, No7, p139-149

**2,2'-Anhydro-L-uridine**[31501-46-9] C<sub>9</sub>H<sub>10</sub>N<sub>2</sub>O<sub>5</sub> 226.19

NA05630

1g	\$42.00
2g	\$73.50
5g	\$157.50

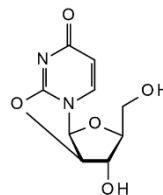
**2,2'-Anhydrouridine**

- 2,2'-Anhydro-b-D-arabinofuranosyl uracil
- O-2,2'-Cyclouridine

[3736-77-4] C<sub>9</sub>H<sub>10</sub>N<sub>2</sub>O<sub>5</sub> 226.19

NA05939

50g	\$75.00
100g	\$120.00
250g	\$275.00

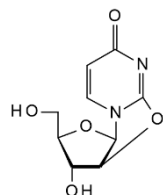

Refs: Ferris JP, Yanagawa H, J. Org. Chem. 1984, 49, p2121

**2-Anilinoadenosine**see *2-Phenylaminoadenosine*, NP07291 on page 340**4-Anilinopyridine**see *N-Phenylpyridin-4-amine*, NP66702 on page 340**5'-O-p-Anisoyl-2,2'-anhydrouridine**C<sub>17</sub>H<sub>16</sub>N<sub>2</sub>O<sub>7</sub> 360.32

NA08203

Price On Application

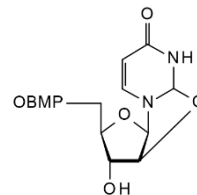

## Anisoylazido

## 5'-O-p-Anisoyl-3'-azido-3'-deoxy-D3-thymidine

C<sub>18</sub>H<sub>16</sub>N<sub>5</sub>O<sub>6</sub>D<sub>3</sub> 404.39

NA08681

Price On Application

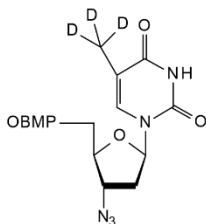

## 5'-O-p-Anisoyl-3'-azido-3'-deoxythymidine

C<sub>18</sub>H<sub>19</sub>N<sub>5</sub>O<sub>6</sub> 401.37

NA08680

Price On Application

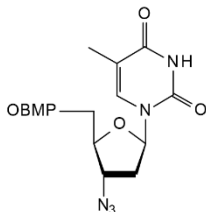

## 5'-O-p-Anisoyl-3'-azido-2',3'-dideoxyuridine

C<sub>17</sub>H<sub>17</sub>N<sub>5</sub>O<sub>6</sub> 387.35

NA08209

Price On Application

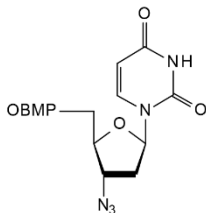

## 5'-O-p-Anisoyl-N6-benzoyl-2'-deoxyadenosine

C<sub>25</sub>H<sub>23</sub>N<sub>5</sub>O<sub>6</sub> 489.48

NA08704

Price On Application

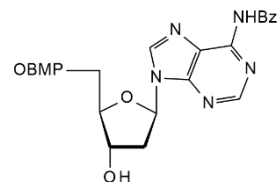

## 5'-O-p-Anisoyl-N4-benzoyl-2',3'-dideoxycytidine

C<sub>24</sub>H<sub>23</sub>N<sub>3</sub>O<sub>6</sub> 449.46

NA08684

Price On Application

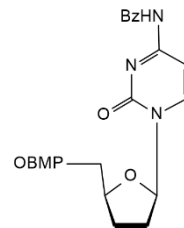

## 5'-O-p-Anisoyl-N4-benzoyl-3'-fluoro-2',3'-dideoxycytidine

C<sub>24</sub>H<sub>22</sub>FN<sub>3</sub>O<sub>6</sub> 467.45

NA08685

Price On Application

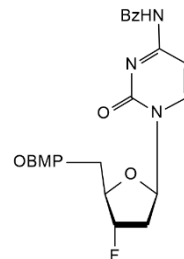

**N4-p-Anisoylcytidine**[28225-17-4] C<sub>17</sub>H<sub>19</sub>N<sub>3</sub>O<sub>7</sub> 377.35

NA07968

50mg	\$89.50
100mg	\$158.00
250mg	\$262.50

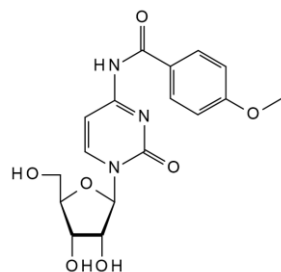
**N4-Anisoyl-2'-deoxycytidine**[48212-99-3] C<sub>17</sub>H<sub>18</sub>N<sub>3</sub>O<sub>6</sub> 361.35

NA07969

25mg	\$89.50
50mg	\$157.50
100mg	\$263.00

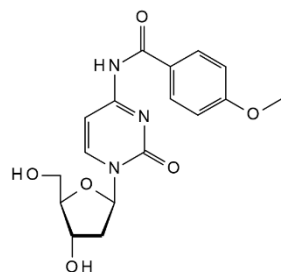
**5'-O-p-Anisoyl-2'-deoxyuridine**C<sub>17</sub>H<sub>18</sub>N<sub>2</sub>O<sub>7</sub> 362.33

NA08690

Price On Application

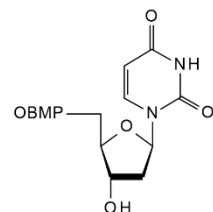
**5'-O-p-Anisoyl-3'-fluoro-3'-deoxythymidine**C<sub>18</sub>H<sub>19</sub>FN<sub>2</sub>O<sub>6</sub> 378.4

NA06300

10mg	\$75.00
25mg	\$110.00
50mg	\$195.00

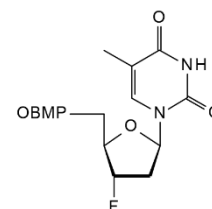
**5'-O-p-Anisoyl-3'-fluoro-2',3'-dideoxyuridine**C<sub>17</sub>H<sub>17</sub>FN<sub>2</sub>O<sub>6</sub> 364.33

NA08202

Price On Application

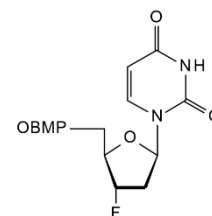
**5'-O-p-Anisoyl-D3-thymidine**C<sub>18</sub>H<sub>17</sub>N<sub>2</sub>O<sub>7</sub>D<sub>3</sub> 379.38

NA08692

Price On Application

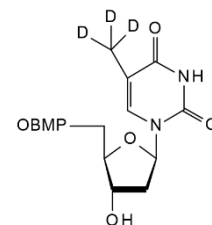

**Anisoylthymi****5'-O-p-Anisoylthymidine**C<sub>18</sub>H<sub>20</sub>N<sub>2</sub>O<sub>7</sub> 376.36

NA08693

Price On Application

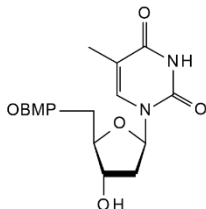
**antisense**

NA11588

Price On Application

**APADH**

see 3-Acetylpyridine adenine dinucleotide, reduced form, sodium salt, NA30684 on page 20

**APAD**

see 3-Acetylpyridine adenine dinucleotide, NA30683 on page 20

**AP3A**

see P1-(5'-Adenosyl) P3-(5'-adenosyl) triphosphate sodium salt, NA46695 on page 29

**Apnea**

see N6-2-(4-Aminophenyl)ethyladenosine, NA72432 on page 60

**Ap5a**

see P1,P5-Di(adenosine-5')pentaphosphate trilithium salt, ND57347 on page 229

**Ara-A**

see 9-(b-D-Arabinofuranosyl)adenine, NA06007 on page 72

**9-(b-D-Arabinofuranosyl)-6-benzylaminopurine**

see 6-Benzylamino-9-(b-D-arabinofuranosyl)purine, NB06159 on page 115

**9-(b-D-Arabinofuranosyl)adenine 5'-monophosphate**

• Vidarabine monophosphate

[29984-33-6] C<sub>10</sub>H<sub>14</sub>N<sub>5</sub>O<sub>7</sub>P 347.22

NA09216

1g	\$40.00
2g	\$60.00
5g	\$115.00

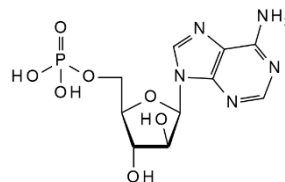
**9-(b-D-Arabinofuranosyl)adenine 5'-triphosphate triethylammonium salt**

• Vidarabine 5'-triphosphate sodium salt

NA15330

1mg	\$504.00
2mg	\$882.00
5mg	\$1837.50

**9-(b-D-Arabinofuranosyl)adenine**

• Vidarabine

• Ara-A

[5536-17-4] C<sub>10</sub>H<sub>13</sub>N<sub>5</sub>O<sub>4</sub> 267.24

NA06007

10g	\$75.00
25g	\$135.00
50g	\$225.00

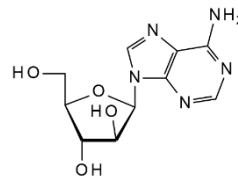

Refs: Wadhwa MS, Rice KG, J. Drug Targeting 2003, 11, 5, p255; Farmer PB, et.al, Biochemistry, 1972, 11, p911

**9-(b-D-Arabinofuranosyl)-N6-benzoyladenine**

• N6-Benzoyl-ara-adenosine

[79896-97-2] C<sub>17</sub>H<sub>17</sub>N<sub>5</sub>O<sub>5</sub> 371.35

NA08318

100mg	\$74.00
250mg	\$132.50
500mg	\$210.00

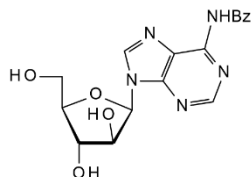
**1-(b-D-Arabinofuranosyl)cytosine HCl**• Cytosine b-D-arabinofuranoside HCl  
• Cytarabine HCl[69-74-9] C<sub>9</sub>H<sub>13</sub>N<sub>3</sub>O<sub>5</sub>·HCl 279.68

NA05780

5g	\$65.00
10g	\$95.00
25g	\$150.00

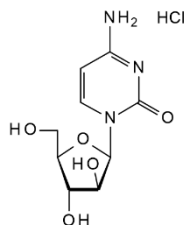

Refs: Dorfman SH, Holtzer H, Silberberg DH, Brain Res. 1976, Mar 12, 104(2) 283-94

**1-(b-D-Arabinofuranosyl)cytosine 5'-monophosphate**• Cytosine b-D-arabinofuranoside 5'-monophosphate  
• Cytarabine 5'-Monophosphate[7075-11-8] C<sub>9</sub>H<sub>14</sub>N<sub>3</sub>O<sub>8</sub>P 323.2

NA10080

25mg	\$68.50
50mg	\$100.00
100mg	\$179.00

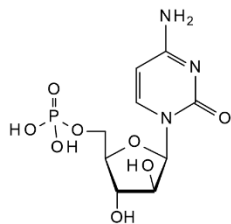
**1-(b-D-Arabinofuranosyl)cytosine 5'-triphosphate triethylammonium salt**

• Cytarabine 5'-triphosphate triethylammonium salt

NA15329

1mg	\$504.00
2mg	\$882.00
5mg	\$1837.50

**1-(b-D-Arabinofuranosyl)cytosine**• Cytosine b-D-arabinofuranoside  
• Cytarabine  
• 4-Amino-1-(b-D-Arabinofuranosyl)-2(1H)pyrimidinone[147-94-4] C<sub>9</sub>H<sub>13</sub>N<sub>3</sub>O<sub>5</sub> 243.22

NA05771

5g	\$47.30
10g	\$84.00
25g	\$157.50

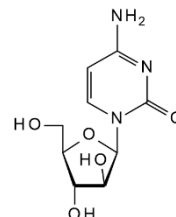

Refs: Donehower RC, et al, Cancer Treat. Rep. 1986, 70, p1059

**9-b-D-Arabinofuranosyl-2-fluoroadenine 5-phosphate**see *Fludarabine phosphate*, NF01485 on page 274**9-b-D-Arabinofuranosyl-2-fluoro-1,9-dihydro-6H-purin-6-one**see *2-Fluoroinosine*, NF17964 on page 278**9-b-D-Arabinofuranosyl-2-fluorohypoxanthine**see *2-Fluoroinosine*, NF17964 on page 278

## Arabinofuran

9-(*b*-D-Arabinofuranosyl)guanine

- Arabinofuranosyl-guanine
- Guanine arabinoside

[38819-10-2] C<sub>10</sub>H<sub>13</sub>N<sub>5</sub>O<sub>5</sub> 283.24

NA06002	100mg	\$50.00
	250mg	\$85.00
	500mg	\$135.00

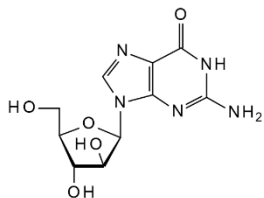

Refs: Cheriyan UO, Ogilvie KK, Nucleosides Nucleotides 1982, 1, p233

9-(*b*-L-Arabinofuranosyl)guanine[469887-93-2] C<sub>10</sub>H<sub>13</sub>N<sub>5</sub>O<sub>5</sub> 283.24

NA35434	100mg	\$5250.00
---------	-------	-----------

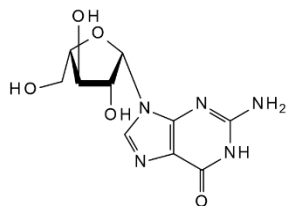

## Arabinofuranosyl-guanine

see 9-(*b*-D-Arabinofuranosyl)guanine, NA06002 on page 749-(*b*-D-Arabinofuranosyl)hypoxanthine

- Arabinofuranosyl-hypoxanthine

[7013-16-3] C<sub>10</sub>H<sub>12</sub>N<sub>4</sub>O<sub>5</sub> 268.23

NA03401	500mg	\$75.00
	1g	\$125.00
	2g	\$220.00

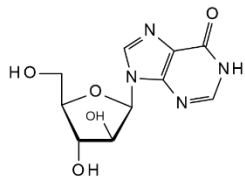

Refs: Sidwell RW, Allen LB, Huffman JH, et al, Antimicrob. Agents Chemother. 1975, 8, p463

## Arabinofuranosyl-hypoxanthine

see 9-(*b*-D-Arabinofuranosyl)hypoxanthine, NA03401 on page 741-(*b*-D-Arabinofuranosyl)-5-iodouracilC<sub>9</sub>H<sub>11</sub>IN<sub>2</sub>O<sub>6</sub> 370.1

NA09572

Price On Application

9-(*b*-D-Arabinofuranosyl)isoguanine

- Arabinosyl-isoguanine

C<sub>10</sub>H<sub>13</sub>N<sub>5</sub>O<sub>5</sub> 283.25

NA09573

10mg	\$65.00
25mg	\$122.50
50mg	\$195.00

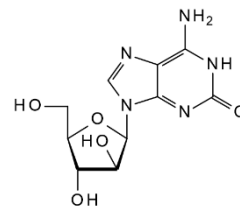
9-*b*-D-Arabinofuranosyl-6-methoxy-9H-purin-2-amine

see Nelarabine, NN26176 on page 331

1-(*b*-D-Arabinofuranosyl)thymine

- Thymine 1-*b*-D-arabinofuranoside

[605-23-2] C<sub>10</sub>H<sub>14</sub>N<sub>2</sub>O<sub>6</sub> 258.23

NA08059

2mg	\$89.30
5mg	\$168.00
10mg	\$225.00

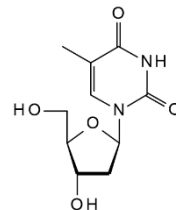

**1-b-D-Arabinofuranosyluracil 5'-monophosphate**

- 1-(5-O-Phosphono-b-D-arabinofuranosyl)-2,4(1H,3H)-pyrimidinedione
- Uracil arabinonucleoside 5'-phosphate

[18354-06-8] C<sub>9</sub>H<sub>13</sub>N<sub>2</sub>O<sub>8</sub>P 324.18

NA16509	1mg	\$294.00
	2mg	\$567.00
	5mg	\$1260.00

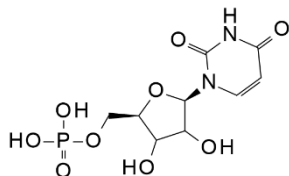
Refs: Kozarich, J, et al, *Biochemistry*, 12, 4458 (1973)**1-(b-L-Arabinofuranosyl)uracil 5'-triphosphate triethylammonium salt**

NA137363

Price On Application

**1-(b-D-Arabinofuranosyl)uracil**

- Ara-U
- Arauridine
- Uracil 1-b-D-arabinofuranoside

[3083-77-0] C<sub>9</sub>H<sub>12</sub>N<sub>2</sub>O<sub>6</sub> 244.2

NA05962	5g	\$60.00
	10g	\$90.00
	25g	\$125.00

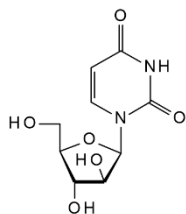
Refs: Zhang HS, Fanf YS, Li YS, *Chromatographia* 2006, 63, 3, p203**Arabinosyl-isoguanine**

see 9-(b-D-Arabinofuranosyl)isoguanine, NA09573 on page 74

**2'-Aracytidine**

NA02919

Price On Application

**Arauridine**

see 1-(b-D-Arabinofuranosyl)uracil, NA05962 on page 75

**Ara-U**

see 1-(b-D-Arabinofuranosyl)uracil, NA05962 on page 75

**Aristeromycin**

see Carbocyclic adenosine, NC29204 on page 135

**Arranon**

see Nelarabine, NN26176 on page 331

**(6aS,8R,9R,9aR)-8-(2-Amino-1,6-dihydro-6-oxo-7H-purin-7-yl)-2,3,6a,8,9,9a-hexahydro-9-hydroxy-4-methoxycyclopenta[c]furo[3',2':4,5]furo[2,3-h][1]benzopyran-1,11-dione**

see AFB-guanine, NA17231 on page 30

**ATP magnesium salt**

see Adenosine 5'-triphosphate magnesium salt, NA44288 on page 27

**8-Azaadenosine**[10299-44-2] C<sub>9</sub>H<sub>12</sub>N<sub>6</sub>O<sub>4</sub> 268.23

NA02698	10mg	\$70.00
	25mg	\$131.25
	50mg	\$200.00



**Azabenzoylde****8-Aza-N6-benzoyl-7-deaza-2'-deoxy-5'-O-DMT-adenosine**[119803-27-9] C<sub>38</sub>H<sub>35</sub>N<sub>5</sub>O<sub>6</sub> 657.71

Price On Application

NA30262

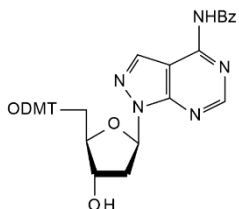
**5-Azacytidine 5'-triphosphate**[2226-74-6] C<sub>8</sub>H<sub>15</sub>N<sub>4</sub>O<sub>14</sub>P<sub>3</sub> 484.14

Price On Application

NA09599

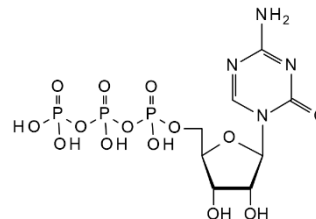
**5-Aza-N6-benzoyl-5'-O-DMT-2'-deoxycytidine 2'-CE phosphoramidite**[929904-98-3] C<sub>46</sub>H<sub>53</sub>N<sub>6</sub>O<sub>9</sub>P 864.92

Price On Application

NA145468

**Azacytidine**

see 5-Azacytidine, NA02947 on page 76

**5-Azacytidine 5'-monophosphate**[2226-72-4] C<sub>8</sub>H<sub>13</sub>N<sub>4</sub>O<sub>8</sub>P 324.18

NA09600

1mg	\$189.00
2mg	\$315.00
5mg	\$708.80

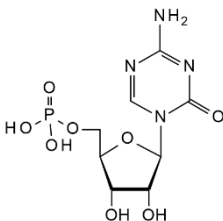
**5-Azacytidine**

- Azacytidine
- Vidaza

[320-67-2] C<sub>8</sub>H<sub>12</sub>N<sub>4</sub>O<sub>5</sub> 244.21

NA02947

1g	\$42.00
2g	\$50.00
5g	\$95.00

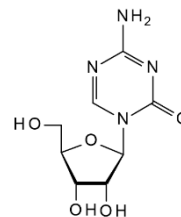

**Refs:** Kusaba H, et al, Eur. J. Biochem. 1999, 262, 924; Broday L, et al, Mol. Cell. Biol. 1999, 19, 3198; Qian X, et al, Am. J. Pathol. 1999, 153, 1475; Canova C, et al, Mech. Ageing Dev. 1998, 101, 153

**6-Azacytidine**

- 6-Azacytosine riboside

[3131-60-0] C<sub>8</sub>H<sub>12</sub>N<sub>4</sub>O<sub>5</sub> 244.2

NA02728

Price On Application

**6-Azacytosine riboside**

see 6-Azacytidine, NA02728 on page 76





**8-Aza-7-deaza-2'-deoxyadenosine**

• 1-(2-Deoxy-b-D-erythro-pentofuranosyl)-1H-pyrazolo[3,4-d]pyrimidin-4-amine

[17318-21-7] C<sub>10</sub>H<sub>13</sub>N<sub>5</sub>O<sub>3</sub> 251.24

NA141793

5mg	\$75.00
10mg	\$125.00
25mg	\$195.00

**8-Aza-7-deaza-2'-deoxy-5'-O-dimethoxytrityl-N6-(N,N-dimethylaminomethylene)-adenosine**

see 8-Aza-7-deaza-2'-deoxy-N2-DMF-5'-O-DMT-, NA146471 on page 77

**8-Aza-7-deaza-2'-deoxy-N2-DMF-5'-O-DMT-**

• 8-Aza-7-deaza-2'-deoxy-5'-O-dimethoxytrityl-N6-(N,N-dimethylaminomethylene)-adenosine

[869355-14-6] C<sub>34</sub>H<sub>36</sub>N<sub>6</sub>O<sub>5</sub> 608.69

NA146471

50mg	\$350.00
100mg	\$500.00
250mg	\$875.00

**8-Aza-7-deaza-2'-deoxyguanosine**[100644-70-0] C<sub>10</sub>H<sub>13</sub>N<sub>5</sub>O<sub>4</sub> 267.24

NA14388

5mg	\$85.00
10mg	\$130.00
25mg	\$195.00

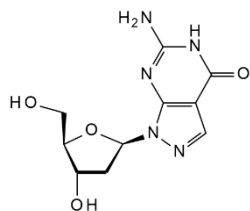
**5-Aza-7-deazaguanosine**

• 2-Amino-8-D-ribofuranosyl-imidazol[1,2-a]-1,3,5-triazin-4(8H)-one

[67410-65-5] C<sub>10</sub>H<sub>13</sub>N<sub>5</sub>O<sub>5</sub> 283.24

NA09785

1mg	\$90.00
2mg	\$150.00
5mg	\$335.00

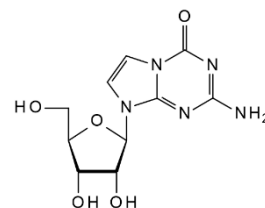
**8-Aza-7-deaza-2'-C-methyladenosine**

NA145111

Price On Application

**8-Aza-2'-deoxyadenosine**

NA141794

50mg	\$1000.00
100mg	\$1550.00
250mg	\$1950.00

**5-Aza-2'-deoxycytidine 5'-triphosphate sodium salt**

NA157213

Price On Application



## Azadeoxycyti

## 5-Aza-2'-deoxycytidine

- Decitabine
- 4-Amino-1-(2-deoxy-b-D-ribofuranosyl)-1,3,5-triazin-2(1H)-one

[2353-33-5] C<sub>8</sub>H<sub>12</sub>N<sub>4</sub>O<sub>4</sub> 228.21

NA02969	100mg	\$75.00
	250mg	\$125.00
	500mg	\$210.00

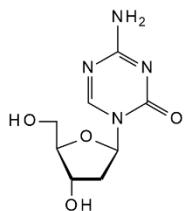

Refs: Wijermans P, Lubbert M, Verhoef G, et al, J. Clin. Onc. 2000, Vol18, Pt5, p956-962

## 6-Aza-2'-deoxyisocytidine

NA76394

Price On Application



## 6-Aza-2'-deoxy-5-methyl-isocytidine

NA76393

Price On Application



## 5-Aza-3',5'-di-O-acetyl-2'-deoxycytidine

C<sub>12</sub>H<sub>16</sub>N<sub>4</sub>O<sub>6</sub> 312.28

NA13520

1g	\$787.50
5g	\$3150.00

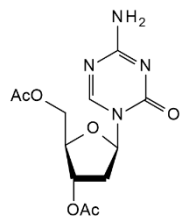

## 8-Aza-6-hydroxy-2-mercaptapurine

- 2-Mercapto-6-hydroxyazapurine

[134811-22-6] C<sub>4</sub>H<sub>3</sub>N<sub>5</sub>OS 169.17

NA66851

1g	\$50.00
2g	\$80.00
5g	\$150.00



## 6-Aza-2-thiouridine

- 2-Thio-6-azauridine

[27089-56-1] C<sub>8</sub>H<sub>11</sub>N<sub>3</sub>O<sub>3</sub>S 261.26

NA08057

50mg	\$60.00
100mg	\$100.00
250mg	\$180.00

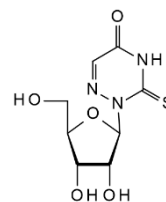

## 6-Azathymine

[932-53-6] C<sub>4</sub>H<sub>5</sub>N<sub>3</sub>O<sub>2</sub> 127.1

NA30768

2g	\$64.00
5g	\$130.00
10g	\$230.00



## 6-Azauridine-5'-monophosphate

[2018-19-1] C<sub>8</sub>H<sub>12</sub>N<sub>3</sub>O<sub>9</sub>P 325.17

NA08373

10mg	\$70.00
25mg	\$135.00
50mg	\$225.00

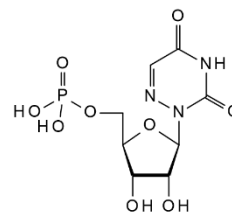

**(-)-6-Azauridine 2',3',5'-triacetate**

see 2',3',5'-Tri-O-acetyl-6-azauridine, NT32421 on page 369

**5-Azauridine**

NA145615	10mg	\$50.00
	25mg	\$112.50
	50mg	\$210.00

**6-Azauridine**[54-25-1] C<sub>8</sub>H<sub>11</sub>N<sub>3</sub>O<sub>6</sub> 245.19

NA02765	500mg	\$50.00
	1g	\$89.30
	2g	\$157.50

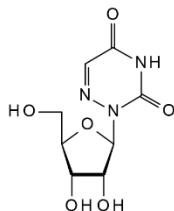
**8-Azidoadenosine 3',5'-cyclic monophosphate free acid**[31966-52-6] C<sub>10</sub>H<sub>11</sub>N<sub>8</sub>O<sub>6</sub>P 370.22

NA09241	1mg	\$105.00
	2mg	\$157.50
	5mg	\$262.50

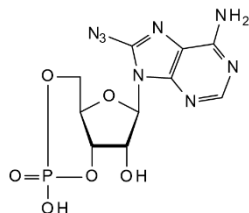
**8-Azidoadenosine 5'-monophosphate sodium salt**[60731-47-7] C<sub>10</sub>H<sub>12</sub>N<sub>8</sub>O<sub>7</sub>P 388.23

NA71640

Price On Application

**8-Azidoadenosine 5'-triphosphate sodium salt - 10mM aqueous solution**[53696-59-6] C<sub>10</sub>H<sub>12</sub>N<sub>8</sub>O<sub>13</sub>P<sub>3</sub>·Na<sub>3</sub> 614.14

NA04422	1mg	\$165.00
	2mg	\$300.00
	5mg	\$550.00

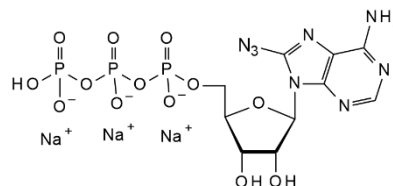
**8-Azidoadenosine 5'-triphosphate tetralithium salt**C<sub>10</sub>H<sub>15</sub>N<sub>8</sub>O<sub>13</sub>P<sub>3</sub> 548.19

NA10278	1mg	\$199.50
	2.5mg	\$367.50
	5 mg	\$656.30

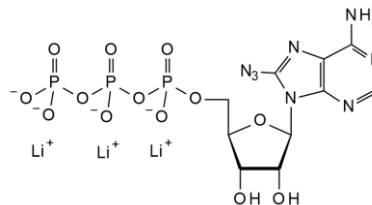

## Azidoadenosine

## 2-Azidoadenosine

[59587-07-4] C<sub>10</sub>H<sub>12</sub>H<sub>8</sub>O<sub>4</sub> 308.25

NA07332

5mg	\$75.00
10mg	\$135.00
25mg	\$300.00

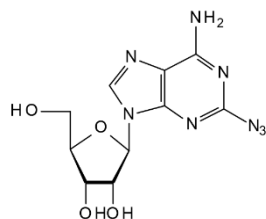

## 8-Azidoadenosine

[4372-67-2] C<sub>10</sub>H<sub>12</sub>N<sub>8</sub>O<sub>4</sub> 308.25

NA06674

25mg	\$81.25
50mg	\$130.00
100mg	\$200.00

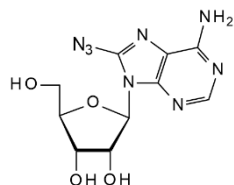

Refs: Holmes RE, Robins RK, J. Am. Chem. Soc. 1965; Jarvis et.al, J. Biol. Chem, 1986, 261, p11077; Viswanadhan et.al, Biochem. Biophys. Acta, 1990, 1039, p356

## 3'-Azido-N6-benzoyl-5'-O-benzoyl-2',3'-dideoxyadenosine

C<sub>24</sub>H<sub>20</sub>N<sub>6</sub>O<sub>4</sub> 484.47

NA08672

Price On Application

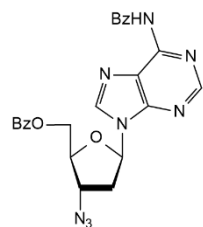

## 3'-Azido-N4-benzoyl-5'-O-benzoyl-2',3'-dideoxycytidine

C<sub>23</sub>H<sub>20</sub>N<sub>6</sub>O<sub>5</sub> 460.44

NA08673

Price On Application

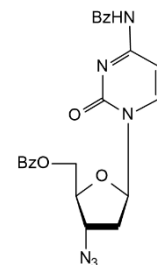

## 3'-Azido-N4-benzoyl-5'-O-tert-butylidimethylsilyl-2',3'-dideoxycytidine

C<sub>22</sub>H<sub>30</sub>N<sub>6</sub>O<sub>4</sub>Si 470.61

NA08674

Price On Application

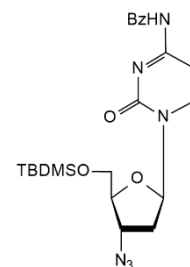

## 3'-Azido-N6-benzoyl-2'-O-tert-butylidimethylsilyl-5'-O-DMT-adenosine

C<sub>39</sub>H<sub>34</sub>N<sub>6</sub>O<sub>6</sub> 698.73

NA06023

Price On Application

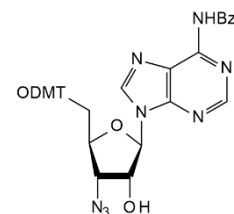

**2'-Azido-N6-benzoyl-2'-deoxy-5'-O-DMT-adenosine**

NA145603

2mg	\$50.00
5mg	\$110.00
10mg	\$180.00

**3'-Azido-N6-benzoyl-2',3'-dideoxyadenosine**C<sub>17</sub>H<sub>16</sub>N<sub>6</sub>O<sub>3</sub> 380.36

NA08675

10mg	\$105.00
25mg	\$203.50
50mg	\$315.00

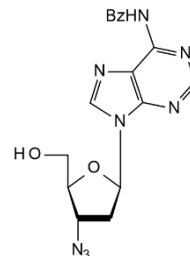
**2'-Azido-N4-benzoyl-2'-deoxy-5'-O-DMT-cytidine**C<sub>37</sub>H<sub>34</sub>N<sub>6</sub>O<sub>7</sub> 674.7

NA11064

Price On Application

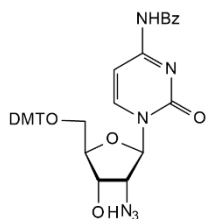
**3'-Azido-N4-benzoyl-2',3'-dideoxycytidine**C<sub>16</sub>H<sub>16</sub>N<sub>6</sub>O<sub>4</sub> 356.34

NA08655

25mg	\$157.50
50mg	\$262.50
100mg	\$420.00

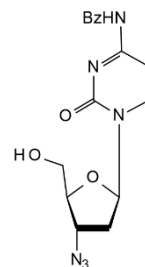
**3'-Azido-5'-O-benzoyl-3'-deoxythymidine**C<sub>17</sub>H<sub>17</sub>N<sub>5</sub>O<sub>5</sub> 371.35

NA08656

25mg	\$105.00
50mg	\$168.00
100mg	\$315.00

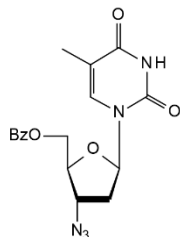
**2'-Azido-N4-benzoyl-2',3'-dideoxy-5'-O-DMT-cytidine**[170236-33-6] C<sub>37</sub>H<sub>34</sub>N<sub>6</sub>O<sub>6</sub> 658.7

NA146469

Price On Application



**Azidobenzoyl****3'-Azido-N4-benzoyl-2',3'-dideoxy-5'-O-DMT-cytidine**

NA145619	10mg	\$50.00
	25mg	\$112.50
	50mg	\$205.00

**3'-Azido-5'-O-benzoyl-2',3'-dideoxyuridine**C<sub>16</sub>H<sub>15</sub>N<sub>5</sub>O<sub>5</sub> 357.32

NA08207	10mg	\$105.00
	25mg	\$203.50
	50mg	\$315.00

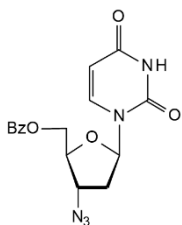
**3'-Azido-N6-benzoyl-5'-O-DMT-2',3'-dideoxyadenosine**C<sub>38</sub>H<sub>34</sub>N<sub>8</sub>O<sub>5</sub> 682.73

NA08676

Price On Application

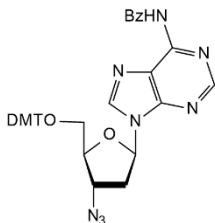
**3'-Azido-N6-benzoyl-5'-O-MMT-2',3'-dideoxyadenosine**C<sub>37</sub>H<sub>32</sub>N<sub>8</sub>O<sub>4</sub> 652.72

NA08677

100mg	\$3950.00
250mg	\$5125.00
500mg	\$6150.00

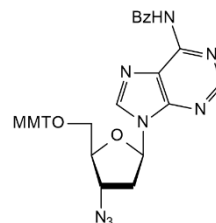
**3'-Azido-N4-benzoyl-5'-O-trityl-2',3'-dideoxyadenosine**C<sub>38</sub>H<sub>30</sub>N<sub>8</sub>O<sub>3</sub> 622.68

NA08678

5mg	\$94.50
10mg	\$157.50
25mg	\$262.50

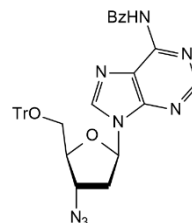
**3'-Azido-5'-O-benzyl-3'-deoxy-D3-thymidine**C<sub>17</sub>H<sub>16</sub>N<sub>5</sub>O<sub>4</sub>D<sub>3</sub> 360.38

NA09238

Price On Application

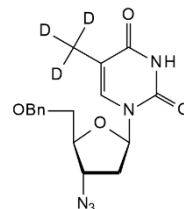

**5'-Azido-N6-Boc-5'-deoxy-2',3'-O-isopropylideneadenosine**[873556-44-6] C<sub>18</sub>H<sub>24</sub>N<sub>6</sub>O<sub>5</sub> 432.43

NA46263

1g

\$4500.00

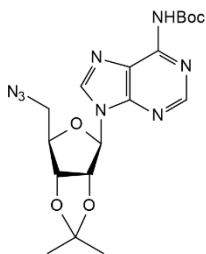
**3'-Azido-5'-O-tert-butylidimethylsilyl-2',3'-dideoxyuridine**C<sub>15</sub>H<sub>25</sub>N<sub>5</sub>O<sub>4</sub>Si 367.48

NA08208

Price On Application

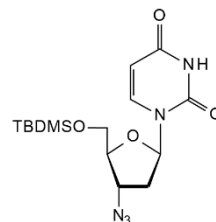
**3'-Azido-5'-O-tert-butylidimethylsilyl-3'-deoxythymidine**C<sub>16</sub>H<sub>27</sub>N<sub>5</sub>O<sub>4</sub>Si 381.51

NA08679

25mg	\$87.00
50mg	\$157.50
100mg	\$263.00

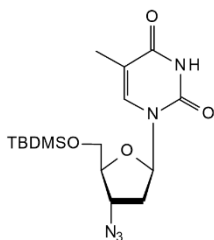
**8-Azidocyclic adenosine diphosphate ribose**[150424-94-5] C<sub>15</sub>H<sub>20</sub>N<sub>6</sub>O<sub>13</sub>P<sub>2</sub> 582.31

NA06324

500ug	\$840.00
1mg	\$1260.00
2mg	\$2100.00

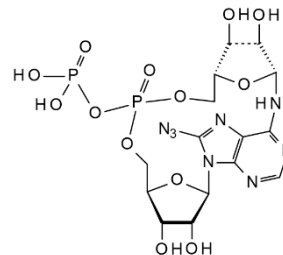
**3'-Azido-5'-O-tert-butylidimethylsilyl-2',3'-dideoxy-N2-isobutrylguanosine**

NA145611

5mg	\$50.00
10mg	\$80.00
25mg	\$185.00

**3'-Azido-ddATP.Li**

see 3'-Azido-2',3'-dideoxyadenosine-5'-triphosphate lithium salt - 100 mM aqueous solution, NA71659 on page 89

**3'-Azido-ddCTP.Li**

see 3'-Azido-2',3'-dideoxycytidine-5'-triphosphate lithium salt - 10 mM aqueous solution, NA71660 on page 89

**3'-Azido-ddGTP.Li**

see 3'-Azido-2',3'-dideoxyguanosine-5'-triphosphate lithium salt - 100mM aqueous solution, NA71661 on page 90

**3'-Azido-ddTTP.Li**

see 3'-Azido-2',3'-dideoxythymidine-5'-triphosphate lithium salt - 100 mM aqueous solution, NA71662 on page 91

**AzidoddUTPLi****3'-Azido-ddUTP.Li**

see 3'-Azido-2',3'-dideoxyuridine-5'-triphosphate lithium salt - 100 mM aqueous solution, NA71663 on page 91

**2'-Azido-2'-deoxyadenosine-5'-triphosphate lithium salt**

$C_{10}H_{15}N_5O_{12}P_3$  532.19 (free acid)

NA09428

1ug \$126.00  
2ug \$230.00  
5ug \$472.50

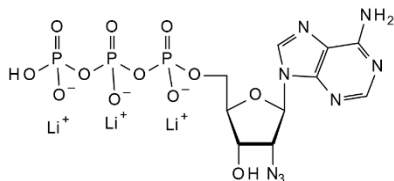
**3'-Azido-2'-deoxyadenosine**

see 3'-Azido-2',3'-dideoxyadenosine, NA06398 on page 89

**5'-Azido-5'-deoxyadenosine**

[737-76-8]  $C_{10}H_{12}N_5O_3$  292.25

NA46264

500mg \$1900.00  
1g \$3000.00

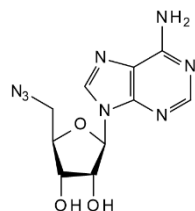
**8-Azido-2'-deoxyadenosine**

[131265-35-5]  $C_{10}H_{12}N_5O_3$  292.25

NA44903

2mg \$60.00  
5mg \$100.00  
10mg \$190.00

**2'-Azido-2'-deoxycytidine-5'-triphosphate**

$C_9H_{15}N_6O_{13}P_3$  508.17

NA09429

1ug \$126.00  
5ug \$472.50  
10ug \$735.00

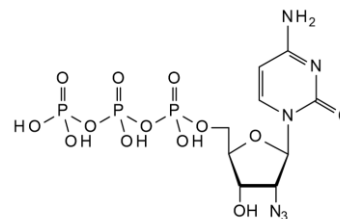
**2'-Azido-2'-deoxycytidine**

• 2'-Azido-2'-deoxycytidine

[51034-68-5]  $C_9H_{12}N_6O_4$  268.2

NA05412

50mg \$90.00  
100mg \$160.00  
250mg \$295.00

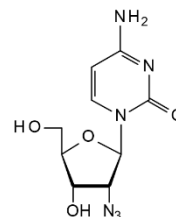
**3'-Azido-2'-deoxy-5'-O-DMT-thymidine**

$C_{31}H_{31}N_5O_6$  569.61

NA08705

100mg \$50.00  
250mg \$100.00  
500mg \$165.00

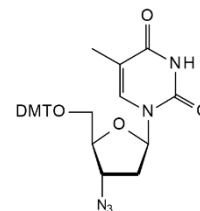



**3'-Azido-3'-deoxy-5'-O-DMT-D3-thymidine**C<sub>31</sub>H<sub>28</sub>N<sub>5</sub>O<sub>7</sub>D<sub>3</sub> 588.62

NA09239

Price On Application

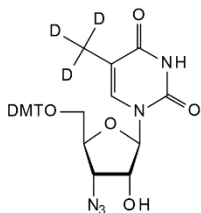
**4'-C-Azido-3'-deoxy-3'-fluorocytidine**[1145869-46-0] C<sub>9</sub>H<sub>11</sub>FN<sub>5</sub>O<sub>4</sub> 286.22

NA32210

250mg	\$2000.00
500mg	\$3000.00
1g	\$4000.00

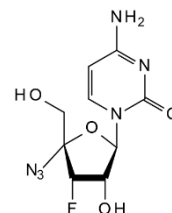
**4'-C-Azido-2'-deoxy-2'-fluoro-b-D-arabinocytidine**[1011529-10-4] C<sub>9</sub>H<sub>11</sub>FN<sub>5</sub>O<sub>4</sub> 286.22

NA32212

1mg	\$225.00
2mg	\$350.00
5mg	\$625.00

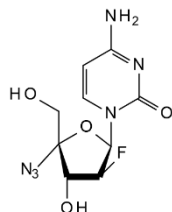
**4'-C-Azido-3'-deoxy-3'-fluorouridine**[1365258-17-8] C<sub>9</sub>H<sub>10</sub>FN<sub>5</sub>O<sub>5</sub> 287.2

NA32211

1g \$9000.00

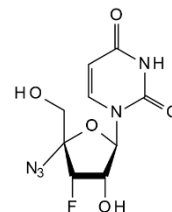
**4'-C-Azido-2'-deoxy-2'-fluoro-b-D-arabinouridine**[173379-73-2] C<sub>9</sub>H<sub>10</sub>FN<sub>5</sub>O<sub>5</sub> 287.2

NA32213

10mg \$800.00

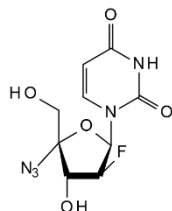
**2'-Azido-2'-deoxyguanosine-5'-triphosphate lithium salt - 100mM aqueous solution**C<sub>10</sub>H<sub>15</sub>N<sub>5</sub>O<sub>13</sub>P<sub>3</sub> 548.19 (free acid)

NA09430

500ug	\$120.00
1mg	\$220.50
2mg	\$409.50

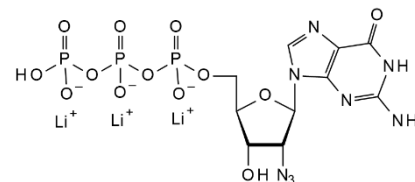

## Azidodeoxygu

## 2'-Azido-2'-deoxyguanosine

[60921-30-4] C<sub>10</sub>H<sub>12</sub>N<sub>6</sub>O<sub>4</sub> 308.25

NA02579

10mg	\$619.50
25mg	\$1045.00
50mg	\$1732.50



## 5'-Azido-5'-deoxyguanosine

[42204-44-4] C<sub>10</sub>H<sub>12</sub>N<sub>6</sub>O<sub>4</sub> 308.25

NA16030

1mg	\$125.00
2mg	\$230.00
5mg	\$425.00

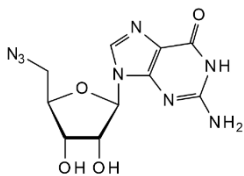

## 5'-Azido-5'-deoxy-2',3'-O-isopropylideneadenosine

[34245-48-2] C<sub>13</sub>H<sub>16</sub>NaO<sub>3</sub> 332.32

NA46265

1g \$2500.00

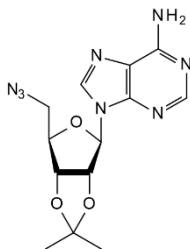

## 5'-Azido-5'-deoxy-2'-O-methyluridine

NA137608

Price On Application



## 3'-Azido-3'-deoxy-5'-O-MMT-D3-thymidine

C<sub>30</sub>H<sub>26</sub>N<sub>5</sub>O<sub>5</sub>D<sub>3</sub> 542.61

NA09240

Price On Application

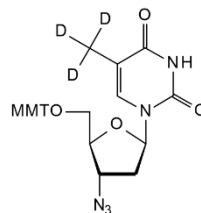

## 3'-Azido-3'-deoxythymidine-b-D-glucuronide sodium salt

• AZT Glucuronide

[133525-01-6] C<sub>16</sub>H<sub>20</sub>N<sub>5</sub>NaO<sub>10</sub> 465.35

NA06316

2mg	\$95.00
5mg	\$135.00
10mg	\$200.00

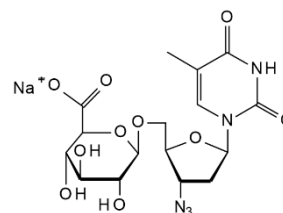

## 3'-Azido-3'-deoxythymidine-methyl-D3-b-D-glucuronide sodium salt

• AZT-methyl-D3 glucuronide

C<sub>16</sub>H<sub>17</sub>D<sub>3</sub>N<sub>5</sub>NaO<sub>10</sub> 468.36

NA04586

1mg	\$425.00
2mg	\$750.00
5mg	\$1625.00

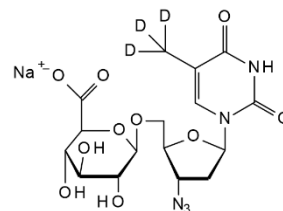

**3'-Azido-3'-deoxythymidine-methyl-D3-2,3,4-tri-O-acetyl-b-D-glucuronide methyl ester**C<sub>23</sub>H<sub>26</sub>D<sub>3</sub>N<sub>5</sub>O<sub>13</sub> 586.52

NA04579

1mg	\$288.80
2mg	\$535.50
5mg	\$1181.30

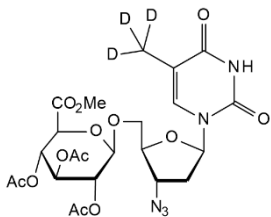
**3'-Azido-3'-deoxythymidine 5'-monophosphate sodium salt**

- Zidovudine 5'-monophosphate sodium salt
- AzTMP

[29706-85-2] C<sub>10</sub>H<sub>13</sub>N<sub>5</sub>NaO<sub>7</sub>P 369.23

NA06326

10mg	\$110.00
25mg	\$200.00
50mg	\$370.00

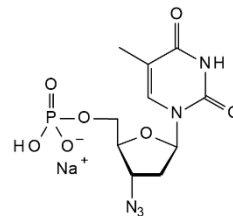
**3'-Azido-3'-deoxythymidine methyl-D3**

• AZT-D3

C<sub>10</sub>H<sub>10</sub>D<sub>3</sub>N<sub>5</sub>O<sub>4</sub> 270.26

NA04603

1mg	\$210.00
2mg	\$378.00
5mg	\$840.00

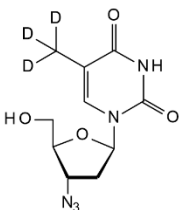

Refs: Mitsuya H, et al, Nature 325, p773, 1987

**3'-Azido-3'-deoxythymidine 2,3,4-tri-O-acetyl-b-D-glucuronide methyl ester**C<sub>23</sub>H<sub>29</sub>N<sub>5</sub>O<sub>13</sub> 583.5

NA04601

5mg	\$68.30
10mg	\$99.80
25mg	\$184.00

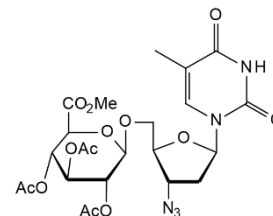
**3'-Azido-3'-deoxythymidine-5'-monophosphate lithium salt - 100 mM aqueous solution**[29706-85-2] C<sub>10</sub>H<sub>14</sub>N<sub>5</sub>O<sub>7</sub>P·xLi 347.22 (free acid basis)

NA32046

Price On Application

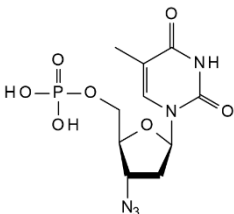
**3'-Azido-3'-deoxythymidine-5'-triphosphate lithium salt - 100mM aqueous solution**

• AzTTP

[92586-35-1] C<sub>10</sub>H<sub>16</sub>N<sub>5</sub>O<sub>13</sub>P<sub>3</sub>·xLi 507.18 (free acid basis)

NA32049

500ug	\$150.00
1mg	\$250.00
2mg	\$450.00

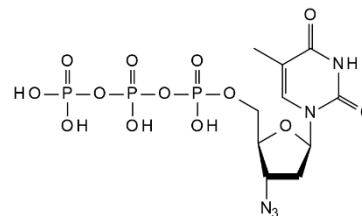

## Azidodeoxyth

**3'-Azido-3'-deoxythymidine 5'-triphosphate triethylammonium salt**

• Zidovudine 5'-triphosphate triethylammonium salt

[127753-52-0] C<sub>22</sub>H<sub>46</sub>N<sub>7</sub>O<sub>13</sub>P<sub>3</sub> 709.52

NA15338

1mg	\$441.00
2mg	\$798.00
5mg	\$1680.00

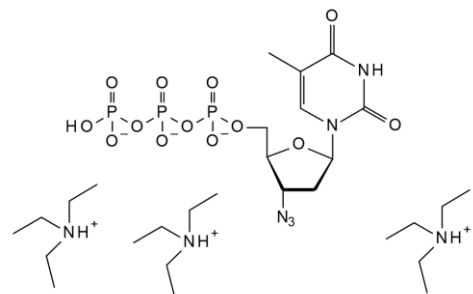
**3'-Azido-3'-deoxythymidine**• AZT  
• Zidovudine  
• Azitidine[30516-87-1][73971-82-1] C<sub>10</sub>H<sub>13</sub>N<sub>5</sub>O<sub>4</sub> 267.24

NA05636

10g	\$60.00
25g	\$95.00
50g	\$150.00

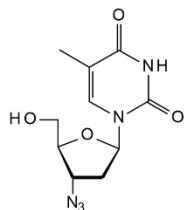

Refs: Mitsuya H, et al, Nature 325, p773, 1987

**5'-Azido-5'-deoxythymidine**[19316-85-9] C<sub>10</sub>H<sub>13</sub>N<sub>5</sub>O<sub>4</sub> 267.24

NA06452

10mg	\$65.00
25mg	\$110.00
50mg	\$175.00

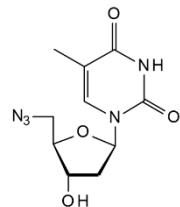
**3'-Azido-3'-deoxy-5'-O-tritylthymidine**

• Zidovudine Impurity 2

[29706-84-1] C<sub>29</sub>H<sub>27</sub>N<sub>5</sub>O<sub>4</sub> 509.56

NA10412

1g	\$100.00
2g	\$170.00
5g	\$330.00

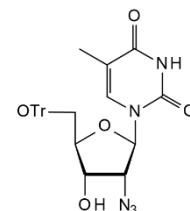
**2'-Azido-2'-deoxyuridine 5'-triphosphate**C<sub>9</sub>H<sub>14</sub>N<sub>5</sub>O<sub>14</sub>P<sub>3</sub> 509.15

NA09431

1ug	\$126.00
5ug	\$472.50
10ug	\$735.00

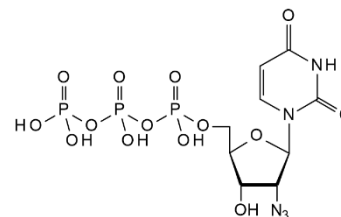
**2'-Azido-2'-deoxy-D-uridine**

see 2'-Azido-2'-deoxyuridine, NA06303 on page 88

**2'-Azido-2'-deoxyuridine**

• 2'-Azido-2'-deoxy-D-uridine

[26929-65-7] C<sub>9</sub>H<sub>11</sub>N<sub>5</sub>O<sub>5</sub> 269.21

NA06303

25mg	\$50.00
50mg	\$90.00
100mg	\$160.00

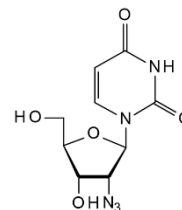

Refs: Van Calenbergh S, Verlinde CLMJ, Soenens J, et al, J. Med. Chem. 1995, Vol38, p3838-3849

**3'-Azido-3'-deoxy-L-uridine**C<sub>9</sub>H<sub>11</sub>N<sub>5</sub>O<sub>5</sub> 269.21

NA139066

Price On Application

**3'-Azido-3'-deoxyuridine**[70580-88-0] C<sub>9</sub>H<sub>11</sub>N<sub>5</sub>O<sub>5</sub> 269.21

NA139017

1mg	\$180.00
2mg	\$300.00
5mg	\$600.00

**5-Azido-2'-deoxyuridine**

NA32296

Price On Application

**3'-Azido-2',3'-dideoxyadenosine-5'-triphosphate lithium salt - 100 mM aqueous solution**

• 3'-Azido-ddATP.Li

C<sub>10</sub>H<sub>15</sub>N<sub>6</sub>O<sub>11</sub>P<sub>3</sub>·xLi 516.19 (free acid basis)

NA71659

500ug	\$175.00
1mg	\$325.00
2mg	\$550.00

**3'-Azido-2',3'-dideoxyadenosine**

- 9-(3-Azido-2,3-dideoxy-b-D-erythro-pentofuranosyl)adenine
- 3'-Azido-2'-deoxyadenosine

[66323-44-2] C<sub>10</sub>H<sub>12</sub>N<sub>6</sub>O<sub>2</sub> 276.26

NA06398

1mg	\$50.00
2mg	\$90.00
5mg	\$175.00

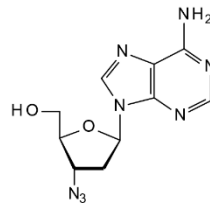

Refs: Herdewijn P, Pauwels R, Baba M, J. Med. Chem. 1987, Vol30, p3131-2137

**3'-Azido-2',3'-dideoxycytidine-5'-triphosphate lithium salt - 10 mM aqueous solution**

• 3'-Azido-ddCTP.Li

C<sub>9</sub>H<sub>15</sub>O<sub>12</sub>N<sub>6</sub>P<sub>3</sub>·xLi 492.17 (free acid basis)

NA71660

500ug	\$175.00
1mg	\$325.00
2mg	\$550.00

**5'-Azido-2',5'-dideoxycytidine**[4803-88-7] C<sub>9</sub>H<sub>12</sub>N<sub>6</sub>O<sub>3</sub> 252.23

NA45440

25mg	\$175.00
50mg	\$275.00
100mg	\$450.00

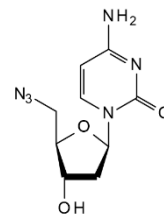

## Azidodideoxy

## 3'-Azido-2',3'-dideoxy-5'-O-DMT-5-methylcytidine N4-succinate

NA145617	10mg	\$50.00
	25mg	\$112.50
	50mg	\$205.00



## 3'-Azido-2',3'-dideoxy-5'-O-DMT-5-methylcytidine

NA145616	25mg	\$50.00
	50mg	\$90.00
	100mg	\$175.00



## 9-(3-Azido-2,3-dideoxy-b-D-erythro-pentofuranosyl)adenine

see 3'-Azido-2',3'-dideoxyadenosine, NA06398 on page 89

## 9-(3-Azido-2,3-dideoxy-b-D-erythro-pentofuranosyl)guanine

see 3'-Azido-2',3'-dideoxyguanosine, NA06550 on page 90

## 5'-Azido-2',5'-dideoxy-2'-fluorouridine

NA137610

Price On Application



## 3'-Azido-2',3'-dideoxyguanosine-5'-triphosphate lithium salt - 100mM aqueous solution

• 3'-Azido-ddGTP.Li

$C_{10}H_{15}NaO_{12}P_3 \cdot xLi$  532.19 (free acid basis)

NA71661	500ug	\$175.00
	1mg	\$325.00
	2mg	\$550.00



## 3'-Azido-2',3'-dideoxyguanosine

• 9-(3-Azido-2,3-dideoxy-b-D-erythro-pentofuranosyl)guanine

[66323-46-4]  $C_{10}H_{12}N_6O_3$  292.25

NA06550

1mg	\$89.30
2mg	\$157.50
5mg	\$315.00

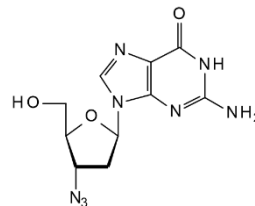

Refs: Perdewijn P, Balzarini J, Baba M, Pauwels R, Van Aershot A, Janssen G, De Clercq E, J. Med. Chem, 1988, 31, p2040



## 5'-Azido-2',5'-dideoxyinosine

[496809-83-7]  $C_{10}H_{11}N_7O_3$  277.24

NA45439

5mg	\$125.00
10mg	\$190.00
25mg	\$350.00

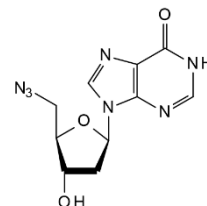

## 3'-Azido-2',3'-dideoxy-N2-isobutrylguanosine

NA145610

10mg	\$50.00
25mg	\$112.50
50mg	\$205.00



**3'-Azido-2',3'-dideoxythymidine-5'-triphosphate lithium salt - 100 mM aqueous solution**

• 3'-Azido-ddTTP.Li

C<sub>10</sub>H<sub>16</sub>N<sub>5</sub>O<sub>13</sub>P<sub>3</sub>·xLi 507.18 (free acid basis)

NA71662

500ug	\$175.00
1mg	\$325.00
2mg	\$550.00

**3'-Azido-2',3'-dideoxy-5'-O-p-toluoyluridine**C<sub>17</sub>H<sub>17</sub>N<sub>5</sub>O<sub>5</sub> 371.35

NA08211

Price On Application

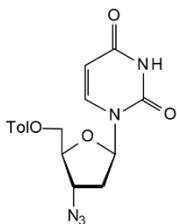
**3'-Azido-2',3'-dideoxyuridine-5'-triphosphate lithium salt - 100 mM aqueous solution**

• 3'-Azido-ddUTP.Li

C<sub>9</sub>H<sub>14</sub>N<sub>5</sub>O<sub>13</sub>P<sub>3</sub>·xLi 493.15 (free acid basis)

NA71663

500ug	\$175.00
1mg	\$325.00
2mg	\$550.00

**3'-Azido-2',3'-dideoxyuridine**[84472-85-5] C<sub>9</sub>H<sub>11</sub>N<sub>5</sub>O<sub>4</sub> 253.21

NA05737

10mg	\$160.00
25mg	\$300.00
50mg	\$475.00

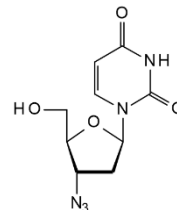

Refs: Boudinot FD, Schinazi RF, Gallo JM, McClure HM, Anderson DC, Doshi KJ, Kambampathi PC, Chu CK, AIDS Res Hum Retroviruses. 1990, 2, p219

**3'-O-Azidomethyl 2'-deoxyadenosine 5'-O-triphosphate sodium salt**

NA46068

Price On Application

**3'-O-Azidomethyl 2'-deoxycytidine 5'-O-triphosphate sodium salt**

NA46069

Price On Application

**3'-O-Azidomethyl 2'-deoxyguanosine 5'-O-triphosphate sodium salt**

NA46070

Price On Application



**Azidomethylid****3'-O-Azidomethyl 2'-deoxythymidine 5'-O-triphosphate sodium salt**

NA45920

Price On Application

**4'-Azidothymidine 5-triphosphate**[140158-13-0] C<sub>10</sub>H<sub>16</sub>N<sub>5</sub>O<sub>14</sub>P<sub>3</sub> 523.18

NA13340

Price On Application

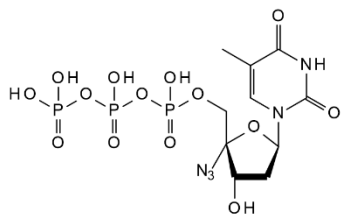
**5-Azidouridine**[1261272-24-5][1355028-82-8] C<sub>9</sub>H<sub>11</sub>N<sub>5</sub>O<sub>6</sub> 285.21

NA16510

5mg	\$94.50
10mg	\$157.50
25mg	\$315.00

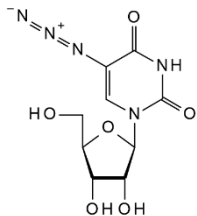
**Azithidine**

see 3'-Azido-3'-deoxythymidine, NA05636 on page 88

**6,6'-Azopurine**[26227-04-3] C<sub>10</sub>H<sub>6</sub>N<sub>10</sub> 266.22

NA16207

Price On Application

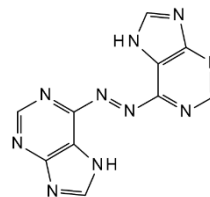
**AZT Glucuronide**

see 3'-Azido-3'-deoxythymidine-b-D-glucuronide sodium salt, NA06316 on page 86

**AZT-methyl-D3 glucuronide**

see 3'-Azido-3'-deoxythymidine-methyl-D3-b-D-glucuronide sodium salt, NA04586 on page 86

**AzTMP**

see 3'-Azido-3'-deoxythymidine 5'-monophosphate sodium salt, NA06326 on page 87

**AzTTP**

see 3'-Azido-3'-deoxythymidine-5'-triphosphate lithium salt - 100mM aqueous solution, NA32049 on page 87

**AZT**

see 3'-Azido-3'-deoxythymidine, NA05636 on page 88

**AZT-D3**

see 3'-Azido-3'-deoxythymidine methyl-D3, NA04603 on page 87

**Baraclude**

see Entecavir hydrate, NE10532 on page 267



**gamma-(BBT)-ATP**

• gamma-[2'(2-benzothiazoyl)-6'-hydroxybenzothiazole]-adenosine-5'-triphosphate sodium salt

$C_{24}H_{22}N_7O_{13}P_3S_2 \cdot xNa$  773.52 (free acid basis)

NB30742

1mg

\$204.80

**gamma-(BBT)-GTP**

• gamma-[2'(2-benzothiazoyl)-6'-hydroxybenzothiazole]-guanosine-5'-triphosphate sodium salt

$C_{24}H_{22}N_7O_{14}P_3S_2 \cdot xNa$  789.52 (free acid basis)

NB30743

1mg

\$204.80

**(-)-BCH-189**

see *Lamivudine*, NL06295 on page 302

**(+)-BCH 189**

see *ent-Lamivudine*, NE22686 on page 268

**gamma-[2'(2-benzothiazoyl)-6'-hydroxybenzothiazole]-adenosine-5'-triphosphate sodium salt**

see *gamma-(BBT)-ATP*, NB30742 on page 93

**gamma-[2'(2-benzothiazoyl)-6'-hydroxybenzothiazole]-guanosine-5'-triphosphate sodium salt**

see *gamma-(BBT)-GTP*, NB30743 on page 93

**[(2S,6R)-6-(N6-Benzoyladenin-9-yl)-4-tritylmorpholin-2-yl]methyl dimethyl-phosphoramidochloridate**

[956139-18-7]  $C_{38}H_{37}ClN_7O_4P$  722.17

NB58201

Price On Application

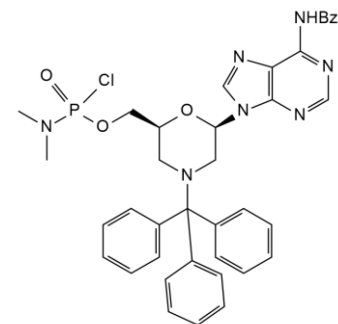
**N6-Benzoyl-L-adenosine**

[868663-26-7]  $C_{17}H_{17}N_5O_5$  371.35

NB09418

10g

\$2625.00

25g

\$4725.00

50g

\$6300.00

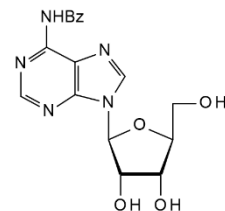
**N6-Benzoyladenosine**

[4546-55-8]  $C_{17}H_{17}N_5O_5$  371.35

NB06291

25g

\$60.00

50g

\$100.00

100g

\$150.00

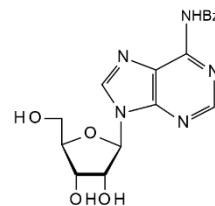

**Benzoylanhyd****5'-O-Benzoyl-2,3'-anhydrothymidine**[70838-44-7] C<sub>17</sub>H<sub>18</sub>N<sub>2</sub>O<sub>5</sub> 330.34

NB03505

25mg	\$65.00
50mg	\$80.00
100mg	\$120.00

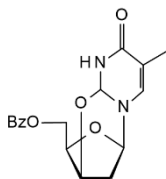

Refs: Czerniecki S, et.al, Nucleosides &amp; Nucleotides, 1995, 14, p1227

**N6-Benzoyl-5'-O-benzoyl-2'-deoxyadenosine**C<sub>24</sub>H<sub>21</sub>N<sub>5</sub>O<sub>5</sub> 459.47

NB08668

Price On Application

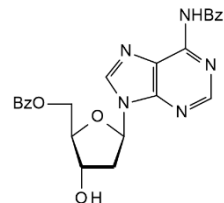
**5'-O-Benzoyl-2,2'-anhydrouridine**C<sub>16</sub>H<sub>14</sub>N<sub>2</sub>O<sub>6</sub> 330.29

NB08212

Price On Application

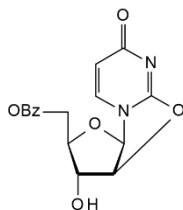
**N4-Benzoyl-5'-O-benzoyl-2'-deoxycytidine**C<sub>23</sub>H<sub>21</sub>N<sub>3</sub>O<sub>6</sub> 435.44

NB08667

Price On Application

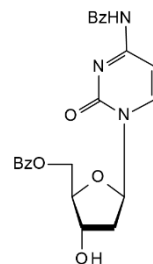
**N6-Benzoyl-ara-adenosine**see 9-(*b*-D-Arabinofuranosyl)-N6-benzoyladenine, NA08318 on page 73**2'(3')-O-(4-Benzoyl)benzoyladenosine-5'-triphosphate triethylammonium salt**

• BzATP triethylammonium salt

[81790-82-1][112898-15-4] C<sub>24</sub>H<sub>24</sub>N<sub>5</sub>O<sub>15</sub>P<sub>3</sub>·xNH<sub>3</sub> 715.39 (free acid basis)

NB29594	1mg	\$57.80
	2mg	\$73.50
	5mg	\$131.30

**N6-Benzoyl-2'-O-tert-butylidimethylsilyladenosine**

• 2'-TBDMS-Bz-rA

[69504-07-0] C<sub>23</sub>H<sub>31</sub>N<sub>5</sub>O<sub>5</sub>Si 485.61

NT57542

1g	\$195.00
2g	\$350.00
5g	\$625.00



**N4-Benzoyl-2'-O-tert-butylidimethylsilylcytidine**

• 2'-TBDMS-Bz-rC

[185398-21-4] C<sub>22</sub>H<sub>31</sub>N<sub>3</sub>O<sub>6</sub>Si 461.58

NT57545

Price On Application

**N6-Benzoyl-3'-O-tert-butylidimethylsilyl-2'-deoxyadenosine**

NB146140

500mg	\$900.00
1g	\$1300.00
2g	\$2000.00

**N6-Benzoyl-5'-O-tert-butylidimethylsilyl-2'-deoxyadenosine**

[51549-39-4]

NB63417

50g	\$700.00
100g	\$1170.00
250g	\$2600.00

**N4-Benzoyl-5'-O-tert-butylidimethylsilyl-2'-deoxycytidine**[51549-36-1] C<sub>22</sub>H<sub>31</sub>N<sub>3</sub>O<sub>5</sub>Si 445.6

NB08718

500mg	\$95.00
1g	\$131.30
2g	\$210.00

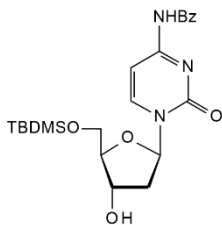
**N4-Benzoyl-5'-O-tert-butylidimethylsilyl-2'-deoxy-5-iodocytidine**C<sub>22</sub>H<sub>30</sub>I<sub>N<sub>3</sub>O<sub>5</sub>Si</sub> 571.48

NB09206

500mg	\$175.00
1g	\$295.00
2g	\$500.00

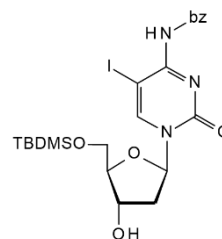
**N6-Benzoyl-2'-O-tert-butylidimethylsilyl-5'-O-DMT-adenosine**[81265-93-2] C<sub>44</sub>H<sub>49</sub>N<sub>5</sub>O<sub>7</sub>Si 787.97

NB15297

1g	\$60.00
2g	\$90.00
5g	\$150.00

**N6-Benzoyl-3'-O-tert-butylidimethylsilyl-5'-O-DMT-adenosine**

• N6-Bz-3'-TBDMS-5'-DMT rA

[81256-88-4] C<sub>44</sub>H<sub>49</sub>N<sub>5</sub>O<sub>7</sub>Si 787.97

NB15524

50mg	\$50.00
100mg	\$86.00
250mg	\$170.00



**Benzoylbutyl****N4-Benzoyl-2'-O-tert-butylidimethylsilyl-5'-O-DMT-cytidine**

• 5'-O-(4,4'-Dimethoxytrityl)-2'-O-(tertbutyldimethylsilyl)-N-benzoyl-Cytidine

[81256-87-3] C<sub>43</sub>H<sub>49</sub>N<sub>3</sub>O<sub>6</sub>Si 763.95

NB15302

100mg	\$55.00
250mg	\$80.00
500mg	\$125.00

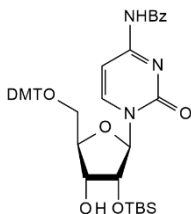
**N4-Benzoyl-3'-O-tert-butylidimethylsilyl-5'-O-DMT-cytidine**

• 5'-DMT-3'-TBDMS-Bz-rC

C<sub>43</sub>H<sub>49</sub>N<sub>3</sub>O<sub>6</sub>Si 763.95

NB33745

Price On Application

**N6-Benzoyl-5'-chloro-5'-deoxy-2',3'-O-isopropylideneadenosine**

NB46326

250mg	\$650.00
500mg	\$950.00
1g	\$1700.00

**[(2S,6R)-6-(N4-Benzoylcydin-1-yl)-4-tritylmorpholin-2-yl]methyl dimethylphosphoramidochloridate**[956139-21-2] C<sub>37</sub>H<sub>37</sub>ClN<sub>5</sub>O<sub>5</sub>P 698.15

NB58202

Price On Application

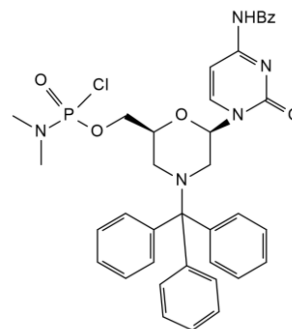
**N4-Benzoyl-L-cytidine**[1018812-31-1] C<sub>16</sub>H<sub>17</sub>N<sub>3</sub>O<sub>6</sub> 347.32

NB09417

100mg	\$85.00
250mg	\$150.00
500mg	\$250.00

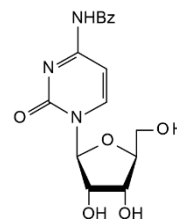
**N4-Benzoylcytidine**[13089-48-0] C<sub>16</sub>H<sub>17</sub>N<sub>3</sub>O<sub>6</sub> 347.32

NB01918

10g	\$45.00
25g	\$85.00
50g	\$150.00

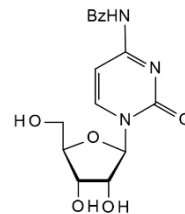

Refs: Gladkaya VA, Levitskaya Z, Shalaim AS, et al, Chem. Nat. Compd. 1990, 25, 4, p488

**N6-Benzoyl-7-deaza-2'-deoxyadenosine**

[95261-09-9]

NB74991

Price On Application

**N6-Benzoyl-7-deaza-2'-deoxy-5'-O-DMT-7-iodoadenosine**

NB137598

Price On Application

**N6-Benzoyl-7-deaza-2'-7-iodoadenosine**

NB137597

Price On Application

**N6-Benzoyl-2'-deoxy-a-adenosine**C<sub>17</sub>H<sub>17</sub>N<sub>5</sub>O<sub>4</sub> 355.36

NB08526

25mg	\$210.00
50mg	\$315.00
100mg	\$473.00

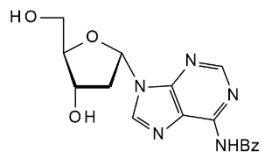
**N6-Benzoyl-2'-deoxyadenosine**[4546-72-9][305808-19-9] C<sub>17</sub>H<sub>17</sub>N<sub>5</sub>O<sub>4</sub> 355.35

NB06336

5g	\$55.00
10g	\$100.00
25g	\$200.00

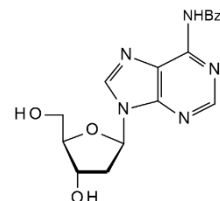
**N6-Benzoyl-3'-deoxyadenosine**[76902-49-3] C<sub>17</sub>H<sub>17</sub>N<sub>5</sub>O<sub>4</sub> 355.35

NB31303

25mg	\$80.00
50mg	\$131.50
100mg	\$231.00

**N6-Benzoyl-5'-O-2'-deoxyadenosine**C<sub>26</sub>H<sub>31</sub>N<sub>5</sub>O<sub>4</sub> 597.66

NB57521

Price On Application

**N4-Benzoyl-2'-deoxy-a-cytidine**C<sub>16</sub>H<sub>17</sub>N<sub>5</sub>O<sub>5</sub> 331.33

NB08374

50mg	\$210.00
100mg	\$315.00
250mg	\$577.50

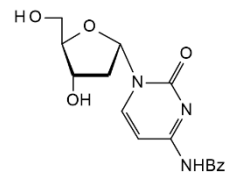

**Benzoyldeoxy****N4-Benzoyl-2'-deoxycytidine**[4836-13-9] C<sub>16</sub>H<sub>17</sub>N<sub>3</sub>O<sub>5</sub> 331.33

NB02991	5g	\$63.00
	10g	\$99.80
	25g	\$173.50

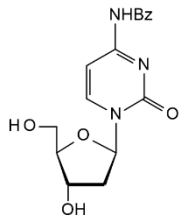
**Refs:**

Koga M, Wilk A, Moore MF, Scremin CL, Zhou L, Beaucauge SL, J. Org. Chem. 1995, 60, p1520

**N4-Benzoyl-3'-deoxycytidine**[161110-00-5] C<sub>16</sub>H<sub>17</sub>N<sub>3</sub>O<sub>5</sub> 331.32

NB02825	5mg	\$84.00
	10mg	\$147.00
	25mg	\$252.00

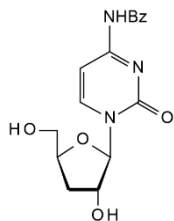
**5'-Benzoyl-3'-deoxy-2',3'-didehydrothymidine**see *Benzoyl stavudine*, NB15927 on page 112**N-Benzoyl-2'-deoxy-5'-dimethoxytrityl-adenosine-3'-[[B-thiobenzoyl-ethyl)-(1-pyrrolidinyl)]-thiophosphoramidite**see *N6-Benzoyl-2'-deoxy-5'-O-DMT-adenosine 3'-thiophosphoramidite*, NB46054 on page 99**N-Benzoyl-2'-deoxy-5'-dimethoxytrityl-cytidine-3'-[[B-thiobenzoyl-ethyl)-(1-pyrrolidinyl)]-thiophosphoramidite**see *N4-Benzoyl-2'-deoxy-5'-O-DMT-cytidine 5'-thiophosphoramidite*, NB46055 on page 101**N6-Benzoyl-2'-deoxy-5'-O-DMT-adenosine 3'-phosphonate triethylammonium salt**C<sub>38</sub>H<sub>35</sub>N<sub>5</sub>O<sub>8</sub>P·C<sub>6</sub>H<sub>16</sub>N 822.89

NB10416	250mg	\$105.00
	500mg	\$185.00
	1g	\$315.00

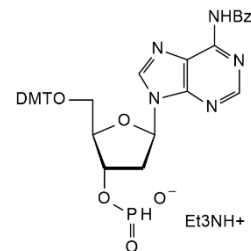
**N6-Benzoyl-2'-deoxy-5'-O-DMT adenosine-3'-Q Linker CPG 1000 Å**

NB11617	250mg	\$60.00
	500mg	\$100.00
	1g	\$157.50

**N6-Benzoyl-2'-deoxy-5'-O-DMT-adenosine 3'-O-succinate triethylammonium salt**[74405-42-8] C<sub>42</sub>H<sub>39</sub>N<sub>5</sub>O<sub>9</sub>·C<sub>6</sub>H<sub>15</sub>N 858.98

NB10413	1g	\$85.00
	2g	\$166.00
	3g	\$243.00

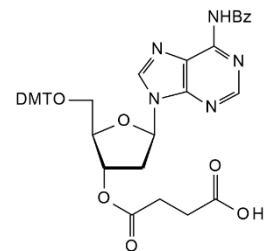

**N6-Benzoyl-3'-deoxy-5'-O-DMT-adenosine 2'-O-succinoyl-long chain alkylamino-CPG**

• 3'-dA-CPG

NB39290

Price On Application

**N5-Benzoyl-2'-deoxy-5'-O-DMT-adenosine 3'-succinyl CPG 500 Å**

NB11627

500mg	\$75.00
1g	\$126.00
2g	\$180.00

**N6-Benzoyl-2'-deoxy-5'-O-DMT-adenosine 3'-succinyl CPG 1400 Å**

NB11607

1g	\$126.00
5g	\$367.50
10g	\$630.00

**N6-Benzoyl-2'-deoxy-5'-O-DMT-adenosine 3'-succinyl CPG 2000 Å**

NB11616

250mg	\$60.00
500mg	\$100.00
1g	\$157.50

**N6-Benzoyl-2'-deoxy-5'-O-DMT-adenosine 3'-thiophosphoramidite**

• N-Benzoyl-2'-deoxy-5'-dimethoxytrityl-adenosine-3'-[(B-thiobenzoyl-ethyl)-(1-pyrroldinyl)]-thiophosphoramidite

C<sub>51</sub>H<sub>51</sub>N<sub>6</sub>O<sub>7</sub>PS<sub>2</sub> 955.09

NB46054

250mg

\$475.00

**N6-Benzoyl-2'-deoxy-3'-O-DMT-adenosine**

[140712-79-4]

NB06925

500mg	\$450.00
1g	\$755.00
2g	\$780.00

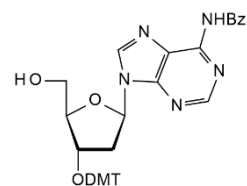
**N6-Benzoyl-2'-deoxy-5'-O-DMT-a-adenosine**C<sub>38</sub>H<sub>35</sub>N<sub>5</sub>O<sub>6</sub> 657.73

NB08529

10mg	\$131.30
25mg	\$262.50
50mg	\$420.00

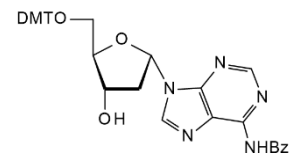

## Benzoyldeoxy

## N6-Benzoyl-2'-deoxy-5'-O-DMT-adenosine

- 5'-O-DMT-N6-benzoyl-2'-deoxy-D-adenosine
- N6-Benzoyl-5'-O-DMT-2'-deoxy-D-adenosine

[64325-78-6] C<sub>38</sub>H<sub>35</sub>N<sub>5</sub>O<sub>6</sub> 657.71

NB02601	5g	\$70.00
	10g	\$110.00
	25g	\$225.00

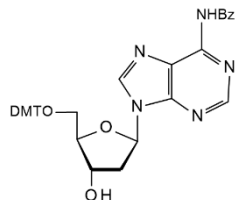

## N6-Benzoyl-3'-deoxy-5'-O-DMT-adenosine

[84138-86-3] C<sub>38</sub>H<sub>35</sub>N<sub>5</sub>O<sub>6</sub> 657.71

NB31304	50mg	\$131.50
	100mg	\$231.00
	250mg	\$500.00



## N4-Benzoyl-2'-deoxy-5'-O-DMT-cytidine 3'-phosphonate triethylammonium salt

C<sub>37</sub>H<sub>35</sub>N<sub>3</sub>O<sub>5</sub>P·C<sub>6</sub>H<sub>15</sub>N 798.86

NB10415	250mg	\$105.00
	500mg	\$185.00
	1g	\$315.00

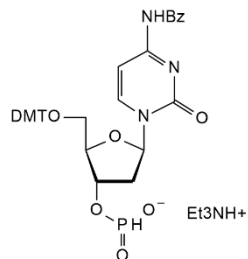

## N4-Benzoyl-2'-deoxy-5'-O-DMT-cytidine 3'-O-succinate triethylamine salt

C<sub>41</sub>H<sub>39</sub>N<sub>3</sub>O<sub>10</sub>·C<sub>6</sub>H<sub>15</sub>N 834.95

NB10414	250mg	\$50.00
	500mg	\$85.00
	1g	\$150.00

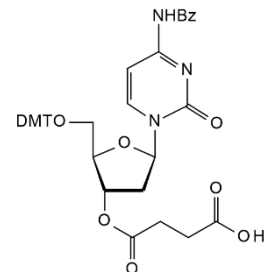

## N4-Benzoyl-2'-deoxy-5'-O-DMT-cytidine 3'-succinyl CPG 1000 Å

NB11645	1g	\$84.00
	5g	\$367.50
	10g	\$630.00



## N4-Benzoyl-2'-deoxy-5'-O-DMT-cytidine 3'-succinyl CPG 1400 Å

NB11619	250mg	\$100.00
	500mg	\$175.00
	1g	\$262.50



## N4-Benzoyl-2'-deoxy-5'-O-DMT-cytidine 3'-succinyl CPG 500 Å

NB11613	500mg	\$85.00
	1g	\$126.00
	2g	\$200.00





**N4-Benzoyl-2'-deoxy-5'-O-DMT-cytidine 5'-thiophosphoramidite**

• N-Benzoyl-2'-deoxy-5'-dimethoxytrityl-cytidine-3'-[(B-thiobenzoyl-ethyl)-(1-pyrrolidinyl)]-thiophosphoramidite

$C_{50}H_{51}N_4O_8PS_2$  931.07

NB46055

250mg

\$475.00

**N4-Benzoyl-2'-deoxy-5'-O-DMT-cytidine**

[67219-55-0]  $C_{37}H_{35}N_3O_7$  633.69

NB02600

5g

\$50.00

10g

\$80.00

25g

\$150.00

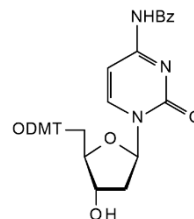
**N4-Benzoyl-2'-deoxy-3'-O-DMT-cytidine**

NB06922

25mg

\$50.00

50mg

\$80.00

100mg

\$140.00

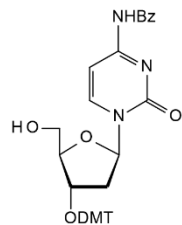
**N4-Benzoyl-3'-deoxy-5'-O-DMT-cytidine**

[86234-45-9]  $C_{37}H_{35}N_3O_7$  633.69

NB02459

10mg

\$157.50

25mg

\$262.50

50mg

\$420.00

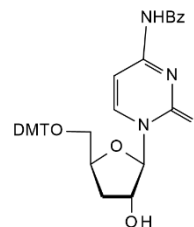
**N4-Benzoyl-2'-deoxy-5'-O-DMT-a-cytidine**

$C_{37}H_{35}N_3O_7$  633.71

NB08528

5mg

\$75.00

10mg

\$125.00

25mg

\$210.00

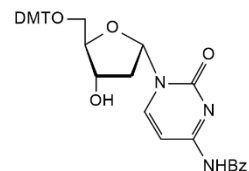
**N2-Benzoyl-9-(2'-deoxy-5'-O-DMT-2'-deoxy-b-D-ribofuranosyl)purine**

$C_{38}H_{35}N_5O_6$  657.71

NB08322

50mg

\$157.50

100mg

\$263.00

250mg

\$420.00

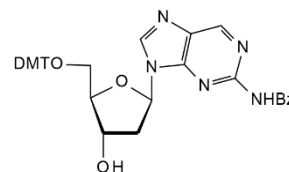

## Benzoyldeoxy

## N6-Benzoyl-2'-deoxy-5'-O-DMT-2'-fluoroadenosine

• DMT-2'-F-Bz-dA

[136834-21-4] C<sub>38</sub>H<sub>34</sub>FN<sub>5</sub>O<sub>6</sub> 675.72

NB08366

250mg	\$75.00
500mg	\$125.00
1g	\$220.00

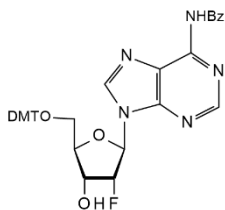

## N6-Benzoyl-3'-deoxy-5'-O-DMT-3'-fluoroadenosine

NB63548

Price On Application



## N6-Benzoyl-9-(2'-deoxy-5'-O-DMT-2'-fluoro-b-D-arabinofuranosyl)adenine 3'-O-succinate triethylammonium salt

C<sub>42</sub>H<sub>38</sub>FN<sub>5</sub>O<sub>9</sub>·C<sub>6</sub>H<sub>16</sub>N 878

NB08474

5mg	\$63.00
10mg	\$99.80
25mg	\$157.50

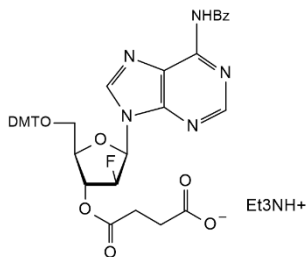

## N6-Benzoyl-9-(2'-deoxy-5'-O-DMT-2'-fluoro-b-D-arabinofuranosyl)adenine

NB08473

5mg	\$94.50
10mg	\$136.50
25mg	\$210.00

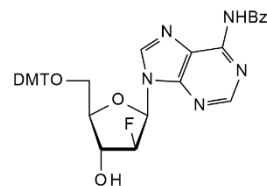

## N4-Benzoyl-1-(2'-deoxy-5'-O-DMT-2'-fluoro-b-D-arabinofuranosyl)cytosine

C<sub>37</sub>H<sub>34</sub>FN<sub>3</sub>O<sub>7</sub> 651.7

NB08469

10mg	\$63.00
25mg	\$94.50
50mg	\$157.50

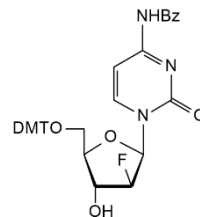

## N4-Benzoyl-1-(2'-deoxy-5'-O-DMT-2'-fluoro-b-D-arabinofuranosyl)-5-methylcytosine-3'-O-succinate triethylammonium salt

C<sub>42</sub>H<sub>40</sub>FN<sub>3</sub>O<sub>10</sub>·C<sub>6</sub>H<sub>16</sub>N 868

NB08467

10mg	\$94.50
25mg	\$157.50
50mg	\$262.50

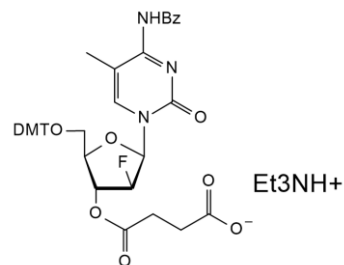

**N4-Benzoyl-1-(2'-deoxy-5'-O-DMT-2'-fluoro-b-D-arabinofuranosyl)-5-methylcytosine**C<sub>38</sub>H<sub>36</sub>FN<sub>3</sub>O<sub>7</sub> 665.72

NB08466

10mg	\$94.50
25mg	\$157.50
50mg	\$262.50

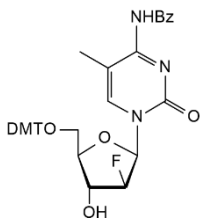
**N4-Benzoyl-2'-deoxy-5'-O-DMT-2'-fluorocytidine**C<sub>37</sub>H<sub>34</sub>FN<sub>3</sub>O<sub>7</sub> 651.7

NB08367

250mg	\$50.00
500mg	\$95.00
1g	\$180.00

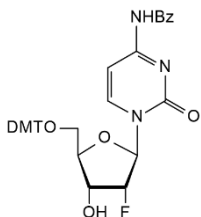
**N4-Benzoyl-2'-deoxy-5'-O-DMT-2'-fluoro-5-methylcytidine**C<sub>38</sub>H<sub>36</sub>FN<sub>3</sub>O<sub>7</sub> 665.72

NB08515

25mg	\$90.00
50mg	\$165.00
100mg	\$295.00

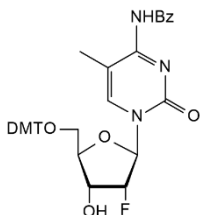
**N2-Benzoyl-2'-deoxy-5'-O-DMT-guanosine**[109464-23-5] C<sub>38</sub>H<sub>35</sub>N<sub>5</sub>O<sub>7</sub> 673.71

NB01948

10g \$3000.00

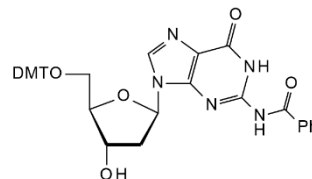
**N4-Benzoyl-2'-deoxy-5'-O-DMT-3'-O-(methanesulfonyl)cytidine**

NB145739

50mg	\$50.00
100mg	\$460.00
250mg	\$1025.00

**N4-Benzoyl-2'-deoxy-5'-O-DMT-5-methylcytidine**[104522-82-2] C<sub>38</sub>H<sub>37</sub>N<sub>3</sub>O<sub>7</sub> 647.72

NB03006

50mg	\$89.50
100mg	\$158.00
250mg	\$262.50

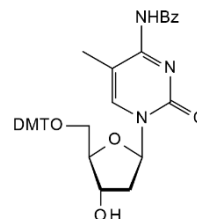
**N4-Benzoyl-2'-deoxy-5'-O-DMT-5-(octa-1,7-diyndyl)cytidine**

NB145745

100mg	\$50.00
250mg	\$115.00
500mg	\$210.00



**Benzoyldeoxy****N6-Benzoyl-2'-deoxy-5'-O-DMT-8-oxo-adenosine**C<sub>38</sub>H<sub>35</sub>N<sub>5</sub>O<sub>7</sub> 673.71

NB10390

25mg	\$89.50
50mg	\$157.50
100mg	\$263.00

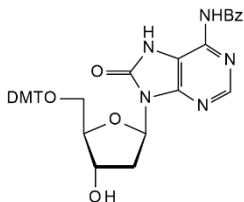
**N6-Benzoyl-9-(2'-deoxy-2'-fluoro-b-D-arabinofuranosyl)adenine**C<sub>17</sub>H<sub>16</sub>FN<sub>5</sub>O<sub>4</sub> 373.35

NB08472

5mg	\$47.30
10mg	\$89.30
25mg	\$136.50

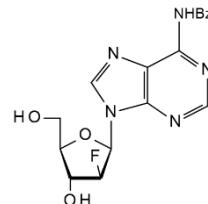
**N4-Benzoyl-2'-deoxy-5'-O-DMT-2'-trifluoroacetamidocytidine**C<sub>39</sub>H<sub>35</sub>F<sub>3</sub>N<sub>4</sub>O<sub>8</sub> 744.71

NB08250

Price On Application

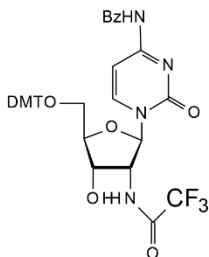
**N4-Benzoyl-1-(2'-deoxy-2'-fluoro-b-D-arabinofuranosyl)cytosine**C<sub>16</sub>H<sub>16</sub>FN<sub>3</sub>O<sub>5</sub> 349.32

NB08465

10mg	\$60.00
25mg	\$95.00
50mg	\$160.00

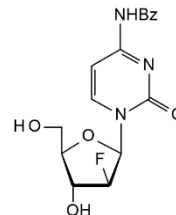
**N6-Benzoyl-2'-deoxy-2'-fluoroadenosine**[136834-20-3] C<sub>17</sub>H<sub>16</sub>FN<sub>5</sub>O<sub>4</sub> 373.34

NB46150

250mg	\$95.00
500mg	\$150.00
1g	\$250.00

**N4-Benzoyl-2'-deoxy-2'-fluorocytidine**C<sub>16</sub>H<sub>16</sub>FN<sub>3</sub>O<sub>5</sub> 349.31

NB57534

Price On Application

**N6-Benzoyl-3'-deoxy-3'-fluoroadenosine**

[129054-67-7]

NB61549

50mg	\$1250.00
100mg	\$2075.00
250mg	\$3250.00

**(2'R)-N-Benzoyl-2'-deoxy-2'-fluoro-2'-methylcytidine 3',5'-d**[817204-32-3] C<sub>31</sub>H<sub>26</sub>FN<sub>3</sub>O<sub>7</sub> 571.55

NB98842

Price On Application



**N6-Benzoyl-9-(3'-O-Deoxy-3'-fluoro-3'-D-xylofuranosyl)adenine**

NB137584

Price On Application

**N4-Benzoyl-1-(3'-Deoxy-3'-fluoro-b-D-xylofuranosyl)cytosine**

NB137582

Price On Application

**5'-O-Benzoyl-2'-deoxyinosine**

NB145906

25mg	\$50.00
50mg	\$80.00
100mg	\$130.00

**N4-Benzoyl-2'-deoxy-5-iodocytidine**[158042-39-8] C<sub>16</sub>H<sub>18</sub>IN<sub>3</sub>O<sub>4</sub> 443.24

NB09266

1g	\$325.00
2g	\$450.00
5g	\$750.00

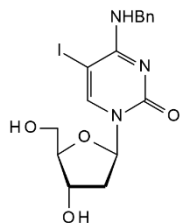
**3'-O-Benzoyl-2'-deoxy-N2-isobutyrylguanosine**[63660-23-1] C<sub>21</sub>H<sub>23</sub>N<sub>5</sub>O<sub>6</sub> 441.44

NB08023

50mg	\$85.00
100mg	\$125.00
250mg	\$225.00

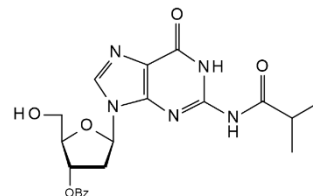
**5'-O-Benzoyl-2'-deoxy-N2-isobutyrylguanosine**C<sub>21</sub>H<sub>23</sub>N<sub>5</sub>O<sub>6</sub> 441.45

NB06917

25mg	\$95.00
50mg	\$150.00

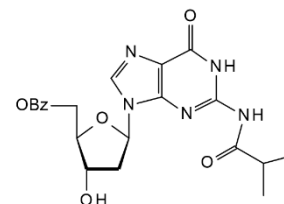
**N6-Benzoyl-2'-deoxy-3'-O-levulinoyladenine**C<sub>22</sub>H<sub>23</sub>N<sub>5</sub>O<sub>6</sub> 453.46

NB06923

Price On Application

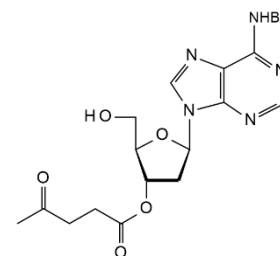

**Benzoyldeoxy****N6-Benzoyl-2'-deoxy-5'-O-levulinoyladenine**C<sub>22</sub>H<sub>23</sub>N<sub>5</sub>O<sub>6</sub> 453.46

NB06924

Price On Application

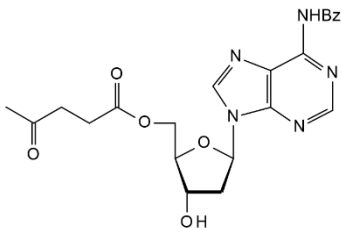
**N4-Benzoyl-2'-deoxy-3'-O-levulinoylcytidine**C<sub>21</sub>H<sub>23</sub>N<sub>3</sub>O<sub>7</sub> 429.43

NB06920

Price On Application

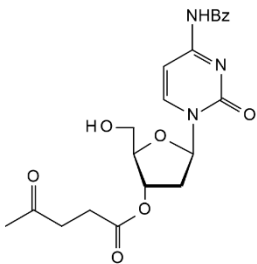
**N4-Benzoyl-2'-deoxy-5'-O-levulinoylcytidine**C<sub>21</sub>H<sub>23</sub>N<sub>3</sub>O<sub>7</sub> 429.43

NB06921

1g

\$60.00

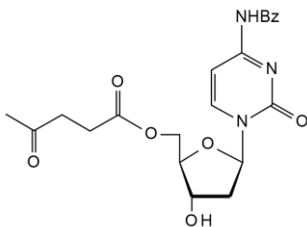
**N6-Benzoyl-2'-deoxy-8-oxoadenosine**[142948-08-1] C<sub>17</sub>H<sub>17</sub>N<sub>5</sub>O<sub>5</sub> 371.35

NB08306

25mg	\$100.00
50mg	\$168.00
100mg	\$310.00

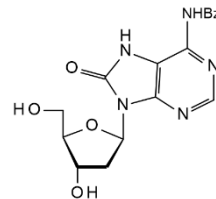
**N6-Benzoyl-2'-deoxy-5'-O-pixyladenosine**C<sub>36</sub>H<sub>29</sub>N<sub>5</sub>O<sub>5</sub> 611.66

NB08553

25mg	\$84.00
50mg	\$157.50
100mg	\$1575.00

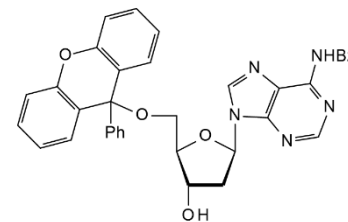
**N4-Benzoyl-2'-deoxy-5'-O-pixylcytidine**C<sub>35</sub>H<sub>29</sub>N<sub>3</sub>O<sub>6</sub> 587.64

NB08554

Price On Application

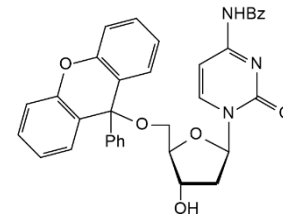

**N4-Benzoyl-2'-deoxy-5'-O-tritylcytidine**C<sub>35</sub>H<sub>31</sub>N<sub>5</sub>O<sub>5</sub> 573.65

NB08967

Price On Application

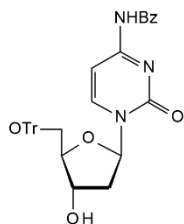
**N6-Benzoyl-2',3'-dideoxyadenosine**C<sub>17</sub>H<sub>17</sub>N<sub>5</sub>O<sub>3</sub> 339.36

NB08369

50mg	\$210.00
100mg	\$394.00
250mg	\$787.50

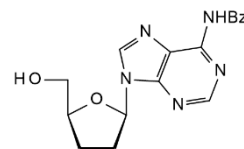
**5'-O-Benzoyl-2',3'-dideoxy-3'-fluorouridine**C<sub>16</sub>H<sub>15</sub>FN<sub>2</sub>O<sub>5</sub> 334.35

NB08204

Price On Application

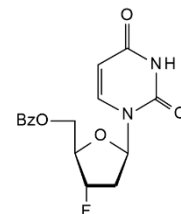
**N6-Benzoyl-5'-O-DMT-adenosine**[81246-82-4] C<sub>38</sub>H<sub>35</sub>N<sub>5</sub>O<sub>7</sub> 673.73

NB07167

1g	\$65.00
2g	\$110.00
5g	\$175.00

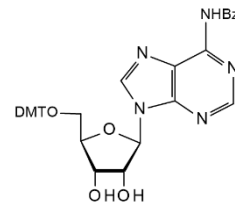
**3'-O-Benzoyl-2'-deoxyuridine**

NB08368

500mg	\$95.00
1g	\$168.00
2g	\$315.00

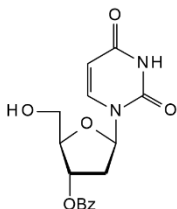
**5'-O-Benzoyl-2'-deoxyuridine**C<sub>16</sub>H<sub>16</sub>N<sub>2</sub>O<sub>6</sub> 332.32

NB09433

Price On Application

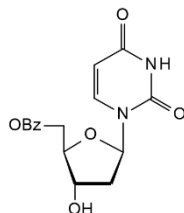

**BenzoylDMTcy****N4-Benzoyl-5'-O-DMT-cytidine**[81246-76-6] C<sub>37</sub>H<sub>35</sub>N<sub>3</sub>O<sub>8</sub> 649.69

NB04589

500mg	\$95.00
1g	\$157.50
2g	\$262.50

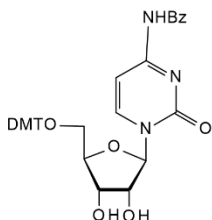
**N6-Benzoyl-5'-O-DMT-2'-deoxy-D-adenosine**see *N6-Benzoyl-2'-deoxy-5'-O-DMT-adenosine*, NB02601 on page 100**N6-Benzoyl-3'-N-DMT-2',3'-dideoxyadenosine**C<sub>38</sub>H<sub>36</sub>N<sub>6</sub>O<sub>5</sub> 656.75

NB09434

Price On Application

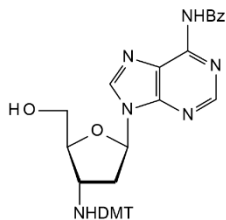
**N4-Benzoyl-5'-O-DMT-2'-O-(2-methoxyethyl)cytidine**

• 5'-O-DMT-2'-MOE-C(Bz)

[251647-49-1] C<sub>40</sub>H<sub>41</sub>N<sub>5</sub>O<sub>9</sub> 707.77

NB36301

500mg	\$175.00
1g	\$235.00
2g	\$450.00

**N4-Benzoyl-5'-O-DMT-2'-O-(2-Methoxyethyl)-5-methylcytidine**

• DMT-2'-O-MOE-C(Bz)

[182496-01-1] C<sub>41</sub>H<sub>43</sub>N<sub>5</sub>O<sub>9</sub> 721.79

NB36300

500mg	\$225.00
1g	\$350.00
2g	\$625.00

**N6-Benzoyl-5'-O-DMT-2'-O-methyladenosine**[110764-72-2] C<sub>39</sub>H<sub>37</sub>N<sub>5</sub>O<sub>7</sub> 687.76

NB08555

250mg	\$50.00
500mg	\$85.00
1g	\$150.00

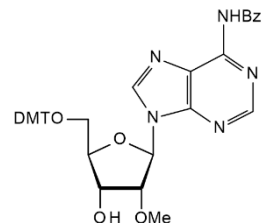
**N6-Benzoyl-5'-O-DMT-N3-methyladenosine**C<sub>39</sub>H<sub>39</sub>N<sub>5</sub>O<sub>7</sub> 689.77

NB08557

Price On Application

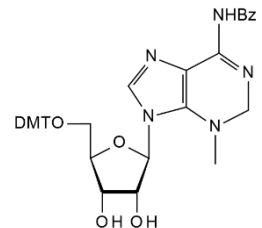



**N4-Benzoyl-5'-O-DMT-2'-O-methylcytidine**[110764-74-4] C<sub>38</sub>H<sub>37</sub>N<sub>3</sub>O<sub>8</sub> 663.72

NB08370

500mg	\$125.00
1g	\$190.00
2g	\$300.00

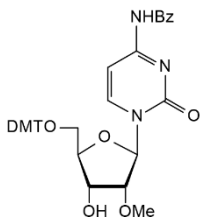
**2'-O-Benzoyl-5'-O-DMT-4-thiouridine**C<sub>37</sub>H<sub>34</sub>N<sub>2</sub>O<sub>6</sub>S 666.76

NB09435

50mg	\$157.50
100mg	\$294.00
250mg	\$577.50

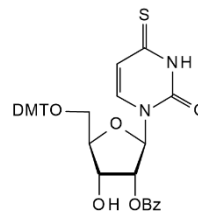
**N4-Benzoyl-5'-O-DMT-5-methylcytidine**C<sub>38</sub>H<sub>37</sub>N<sub>3</sub>O<sub>8</sub> 663.73

NB09436

100mg	\$50.00
250mg	\$95.00
500mg	\$175.00

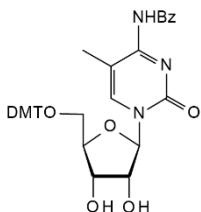
**N2-Benzoylguanosine**[3676-72-0] C<sub>17</sub>H<sub>17</sub>N<sub>5</sub>O<sub>6</sub> 387.35

NB06331

250mg	\$67.50
500mg	\$105.00
1g	\$189.00

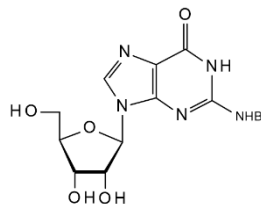

Refs: McLaughlin LW, et al,

**N4-Benzoyl-5'-O-DMT-2'-O-methyl-5-methylcytidine**

• N4-Bz-5-Me-DMT-2'-O-Me-C

C<sub>39</sub>H<sub>39</sub>N<sub>3</sub>O<sub>8</sub> 677.74

NB09205

250mg	\$87.50
500mg	\$150.00
1g	\$250.00

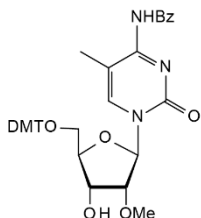
**N6-Benzoyl-8-hydroxy-2'-O-methyladenosine**

NB145742

Price On Application

**N-Benzoyl-5'-O-DMTR-2'-O-(2-methoxyethyl)-adenosine**see *N-Benzoyl-5'-O-(bis(4-methoxyphenyl)phenylmethyl)-2'-O-(2-methoxyethyl)adenosine*, NB16316 on page 111

## Benzoylhydro

## N6-Benzoyl-7'-hydroxymorpholino adenosine monomer

[956139-16-5]  $C_{36}H_{32}N_6O_3$  596.68  
 NB138535 2g \$1500.00

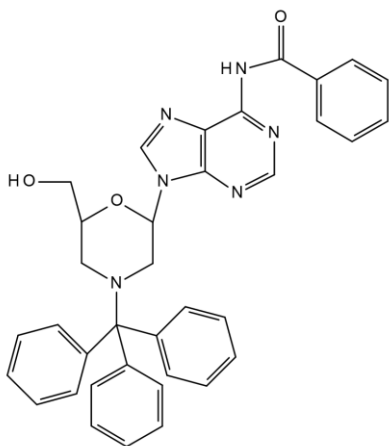

## N4-Benzoyl-7'-hydroxymorpholino cytidine monomer

[125515-31-3]  $C_{35}H_{32}N_4O_4$  572.65  
 NB138534 2g \$1300.00

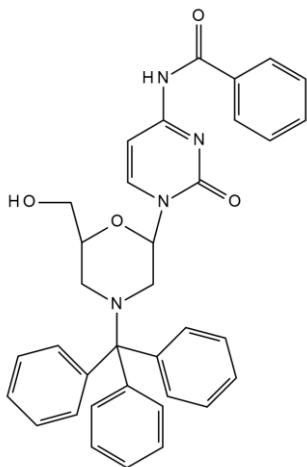

## N6-Benzoyl-2',3'-isopropylideneadenosine

$C_{20}H_{21}N_5O_5$  411.41  
 NB08544 1g \$80.00  
 2g \$150.00  
 5g \$325.00

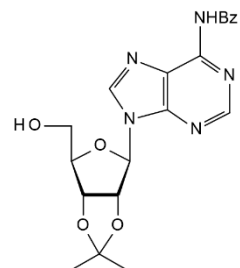

## 5-O-Benzoyl-1,2-O-isopropylidene-3-O-methyl-α-D-xylofuranose

NB137592

Price On Application



## N6-Benzoyl-9-(α-D-mannopyranosyl)adenine

$C_{18}H_{19}N_5O_6$  401.37  
 NB09534 25g \$3019.00  
 50g \$5250.00  
 100g \$9135.00

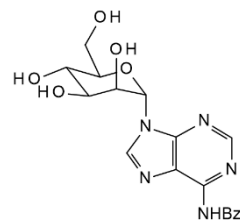

**N4-Benzoyl-1-( $\alpha$ -D-mannopyranosyl)cytosine**C<sub>17</sub>H<sub>19</sub>N<sub>5</sub>O<sub>7</sub> 377.35

NB09533

25g	\$3019.00
50g	\$5250.00
100g	\$9135.00

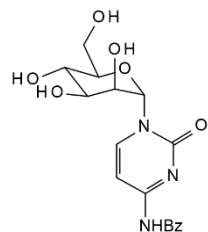
**N6-Benzoyl-2'-O-methyladenosine**[85079-00-1] C<sub>18</sub>H<sub>19</sub>N<sub>5</sub>O<sub>5</sub> 385.37

NB57530

1g	\$160.00
2g	\$290.00
5g	\$575.00

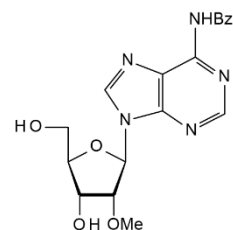
**N-Benzoyl-5'-O-(bis(4-methoxyphenyl)phenylmethyl)-2'-O-(2-methoxyethyl)adenosine**

• N-Benzoyl-5'-O-DMTR-2'-O-(2-methoxyethyl)-adenosine

[251647-48-0] C<sub>41</sub>H<sub>41</sub>N<sub>5</sub>O<sub>8</sub> 731.79

NB16316

500mg	\$425.00
1g	\$650.00
2g	\$1100.00

**N6-Benzoyl-3'-O-methyladenosine**C<sub>18</sub>H<sub>19</sub>N<sub>5</sub>O<sub>5</sub> 385.37

NB08332

50mg	\$110.50
100mg	\$200.00
250mg	\$455.00

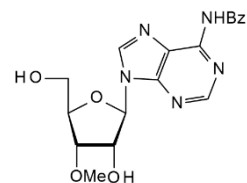
**N6-Benzoyl-2'-C-methyladenosine**

NB137591

Price On Application

**N4-Benzoyl-2'-C-methylcytidine**

NB137590

Price On Application



**Benzoylmethy****N4-Benzoyl-2'-O-methylcytidine**[52571-45-6] C<sub>17</sub>H<sub>19</sub>N<sub>3</sub>O<sub>6</sub> 361.35

NB06418	1g	\$85.00
	2g	\$150.00
	5g	\$250.00

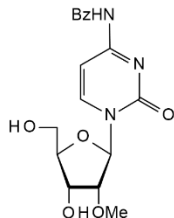
**N4-Benzoyl-5-methylcytidine**C<sub>17</sub>H<sub>19</sub>N<sub>3</sub>O<sub>6</sub> 361.35

NB08333	250mg	\$120.00
	500mg	\$210.00
	1g	\$315.00

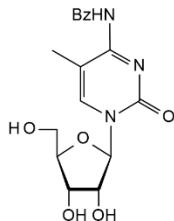
**N6-Benzoyl-9-(3'-O-methyl-b-D-xylofuranosyl)adenine**

NB137578

Price On Application

**N4-Benzoyl-1-(3-O-methyl-b-D-xylofuranosyl)cytosine**

NB137576

Price On Application

**N6-Benzoyl-7'-OH-N-trityl morpholino adenosine**

[956139-16-5]

NB138671	5g	\$3250.00
	10g	\$5200.00

**N4-Benzoyl-7'-OH-N-trityl morpholino cytosine**

[125515-31-3]

NB138670	5g	\$2500.00
	10g	\$3950.00

**3-Benzoylpyridine**

• Phenyl 3-pyridyl ketone

[5424-19-1] C<sub>12</sub>H<sub>9</sub>NO 183.21

NB70237	10g	\$50.00
	25g	\$72.50
	50g	\$130.00

**Benzoyl stavudine**

• 5'-Benzoyl-3'-deoxy-2',3'-didehydrothymidine

[122567-97-9] C<sub>17</sub>H<sub>16</sub>N<sub>2</sub>O<sub>5</sub> 328.32

NB15927	100mg	\$1250.00
	250mg	\$1875.00
	500mg	\$2500.00



**N6-Benzoyl-3',5'-O-(1,1,3,3-tetraisopropyl-1,3-disiloxanediyl)adenosine**

- N6-Benzoyl-3',5'-O-TIPPS-adenosine
- 3',5'-O-TIPPS-N6-benzoyl-adenosine

[79154-57-7] C<sub>29</sub>H<sub>43</sub>N<sub>5</sub>O<sub>6</sub>Si<sub>2</sub> 613.87

NB09330	1g	\$65.00
	2g	\$110.00
	5g	\$195.00

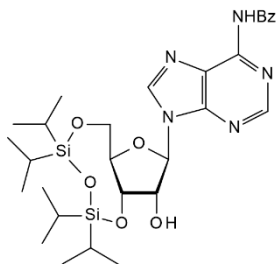
**N4-Benzoyl-3',5'-O-(1,1,3,3-tetraisopropyl-1,3-disiloxanediyl)cytidine**[69304-43-4] C<sub>28</sub>H<sub>43</sub>N<sub>3</sub>O<sub>7</sub>Si<sub>2</sub> 589.83

NB12322	1g	\$78.00
	2g	\$125.00
	5g	\$250.00

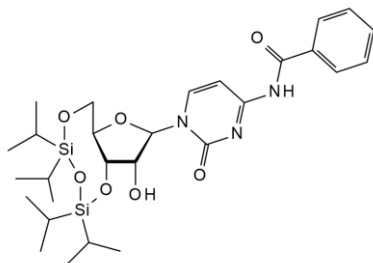
**N4-Benzoyl-1-(b-L-threonyl)cytosine**

NB137588

Price On Application

**3'-O-Benzoylthymidine**[17331-53-2] C<sub>17</sub>H<sub>18</sub>N<sub>2</sub>O<sub>6</sub> 346.34

NB08509

500mg	\$95.00
1g	\$165.00
2g	\$315.00

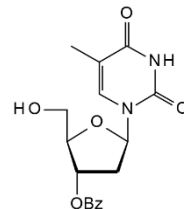
**5'-O-Benzoyl-D3-thymidine**C<sub>17</sub>H<sub>15</sub>N<sub>2</sub>O<sub>6</sub>D<sub>3</sub> 349.36

NB08970

Price On Application

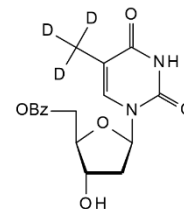
**5'-O-Benzoylthymidine**[65475-51-6] C<sub>17</sub>H<sub>18</sub>N<sub>2</sub>O<sub>6</sub> 346.34

NB08969

Price On Application

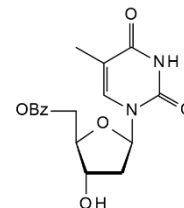
**N6-Benzoyl-3',5'-O-TIPPS-adenosine**

see N6-Benzoyl-3',5'-O-(1,1,3,3-tetraisopropyl-1,3-disiloxanediyl)adenosine, NB09330 on page 113

**Benzyltrity****N6-Benzoyl-5'-O-trityl-adenosine**C<sub>36</sub>H<sub>31</sub>N<sub>5</sub>O<sub>5</sub> 613.66

NB57523

Price On Application

**N4-Benzoyl-5'-O-Trityl-cytidine**C<sub>35</sub>H<sub>31</sub>N<sub>5</sub>O<sub>6</sub> 589.64

NB57524

Price On Application

**N6-Benzyladenosine 5'-O-diphosphate sodium salt**

• 6-Bn-ADP

[40811-89-0] C<sub>17</sub>H<sub>21</sub>N<sub>5</sub>O<sub>10</sub>P<sub>2</sub> 517.32

NB45915

1mg	\$225.00
2mg	\$290.00
5mg	\$675.00

**N6-Benzyladenosine 5'-monophosphate sodium salt**

• 6-Benzylamino-9-b-D-ribofuranosylpurine-5'-monophosphate disodium monohydrate

[13484-66-7] C<sub>17</sub>H<sub>18</sub>N<sub>5</sub>Na<sub>2</sub>O<sub>7</sub>·H<sub>2</sub>O 499.32

NB30216

1mg	\$295.00
2mg	\$420.00
5mg	\$975.00

**N6-Benzyladenosine 5'-O-triphosphate sodium salt**[40922-97-2] C<sub>17</sub>H<sub>22</sub>N<sub>5</sub>O<sub>13</sub>P<sub>3</sub> 597.3

NB45917

1mg	\$325.00
2mg	\$430.00
5mg	\$975.00

**N6-Benzyladenosine triphosphate triethylammonium salt**[40922-97-2] C<sub>19</sub>H<sub>26</sub>N<sub>5</sub>O<sub>11</sub>P<sub>3</sub>·C<sub>18</sub>H<sub>48</sub>N<sub>3</sub> 899.95

NB04595

Price On Application

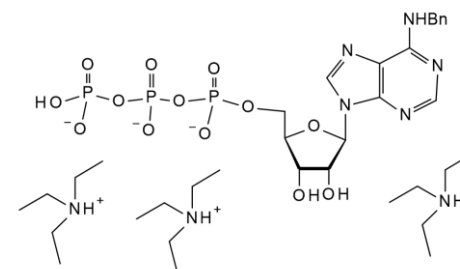
**N6-Benzyladenosine**

• 6-Benzylaminopurine riboside

[4294-16-0] C<sub>17</sub>H<sub>19</sub>N<sub>5</sub>O<sub>4</sub> 357.36

NB06325

250mg	\$50.00
500mg	\$90.00
1g	\$130.00

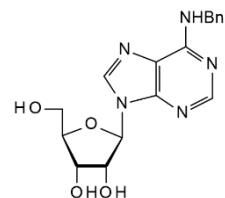

Refs: Strnad M, J. Plant Growth Reg. 1996, 15, 4, p179-188



B

**6-Benzylamino-9-(b-D-arabinofuranosyl)purine**

• 9-(b-D-Arabinofuranosyl)-6-benzylaminopurine

C<sub>17</sub>H<sub>19</sub>N<sub>5</sub>O<sub>4</sub> 357.37

NB06159

100mg	\$105.00
500mg	\$265.00
1g	\$420.00

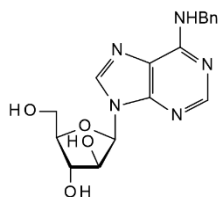
**6-Benzylamino-9-(2'-deoxy-b-D-ribofuranosyl)purine**C<sub>17</sub>H<sub>19</sub>N<sub>5</sub>O<sub>3</sub> 341.36

NB10030

100mg	\$126.00
250mg	\$210.00
500mg	\$315.00

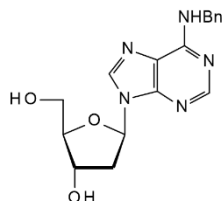
**6-Benzylamino-9-(2'-deoxy-b-D-ribofuranosyl)purine**see *N6-Benzyl-2-deoxyadenosine*, NB05230 on page 116**6-Benzylamino-9-(a-D-glucopyranosyl)purine**[4294-17-1] C<sub>18</sub>H<sub>21</sub>N<sub>5</sub>O<sub>5</sub> 387.4

NB04599

5mg	\$157.50
10mg	\$252.00
25mg	\$577.50

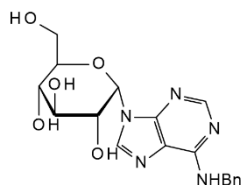
**6-Benzylaminopurine riboside**see *N6-Benzyladenosine*, NB06325 on page 114**6-Benzylamino-9-b-D-ribofuranosylpurine-5'-monophosphate disodium monohydrate**see *N6-Benzyladenosine-5'-monophosphate sodium salt*, NB30216 on page 114**5'-O-Benzyl-2,2'-anhydrouridine**C<sub>16</sub>H<sub>16</sub>N<sub>2</sub>O<sub>5</sub> 316.31

NB08298

Price On Application

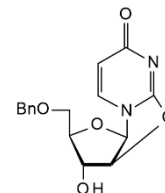
**O6-Benzyl-8-bromo-3',5'-O(1,1,3,3-tetrakis(isopropyl)-1,3-disiloxanediyl)2'-deoxyguanine**

• 8-Bromo-2'-deoxy-6-O-(phenylmethyl)-3',5'-O-[1,1,3,3-tetrakis(1-methylethyl)-1,3-disiloxanediyl]guanosine

[328394-26-9] C<sub>29</sub>H<sub>44</sub>BrN<sub>5</sub>O<sub>5</sub>Si<sub>2</sub> 678.77

NB18375

5mg	\$140.00
10mg	\$254.50
25mg	\$463.00

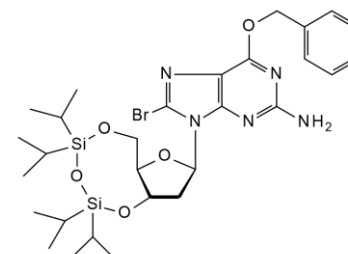
**N2-Benzyl-2'-O-tert-butylidimethylsilyl-5'-O-DMT-guanosine 3'-CE phosphoramidite**

[778611-78-2]

NB139126

Price On Application



**Benzylchloro****7-Benzyl-4-chloro-5-iodo-7H-pyrrolo[2,3-d]pyrimidine**

[1244855-59-1]

NB44294

500mg	\$75.00
1g	\$119.70
2g	\$191.40

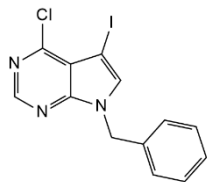
**7-Benzyl-4-chloro-5,6,7,8-tetrahydropyrido[3,4-d]pyrimidine**

[192869-80-0] 259.73

NB57451

Price On Application

**N6-Benzyl-2-deoxyadenosine**

- 9-(2-Deoxy-b-D-ribofuranosyl)-6-benzylaminopurine
- 6-Benzylamino-9-(2'-deoxy-b-D-ribofuranosyl)purine

C<sub>17</sub>H<sub>19</sub>N<sub>5</sub>O<sub>3</sub> 341.36

NB05230

100mg	\$116.00
250mg	\$210.00
500mg	\$370.00

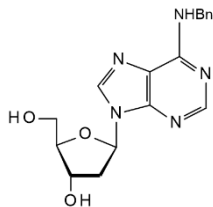
**6-O-Benzyl-2'-deoxyguanosine**

- 2'-Deoxy-6-O-(phenylmethyl)guanosine

[129732-90-7] C<sub>17</sub>H<sub>19</sub>N<sub>5</sub>O<sub>4</sub> 357.36

NB16627

5mg	\$140.00
10mg	\$254.50
25mg	\$463.00

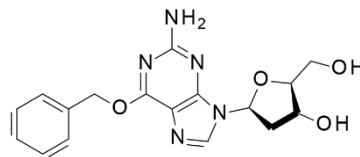

Refs: Kokkinakis, D, et al, Clin. Cancer Res, 9, 3801 (2003)

**5'-O-Benzyl-N2-DMF-2'-deoxyguanosine**C<sub>20</sub>H<sub>24</sub>N<sub>6</sub>O<sub>4</sub> 412.44

NB10283

Price On Application

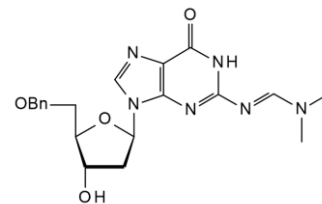
**N6-Benzyl-5'-ethylcarboxamidoadenosine**

- N6-Benzyl-NECA
- 1-Deoxy-N-ethyl-1-[6-[(phenylmethyl)amino]-9H-purin-9-yl]-b-D-ribofuranuronamide

[152918-32-6] C<sub>19</sub>H<sub>22</sub>N<sub>6</sub>O<sub>4</sub> 398.42

NB06327

10mg	\$89.30
25mg	\$157.50
50mg	\$262.50

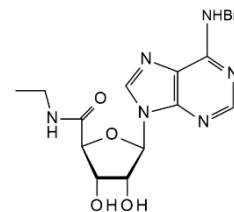

Refs: Gallo-Rodriguez, et al, J. Med. Chem. 1994, 37, p636



**O6-Benzyl guanosine**

- O6-Benzylguanosine
- 2-Amino-6-(benzyloxy)-9-β-D-ribofuranosyl-purine
- 6-O-(Phenylmethyl)guanosine

[4552-61-8] C<sub>17</sub>H<sub>19</sub>N<sub>5</sub>O<sub>5</sub> 373.36

NB16621

10mg	\$139.80
25mg	\$254.50
50mg	\$462.00

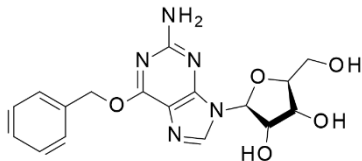

Refs: Hebert, M, et al, J. Biol. Chem, 273, 5557 (1998)

**O6-Benzylguanosine**see *O6-Benzyl guanosine*, NB16621 on page 117**6-Benzyl-4-hydroxy-2-mercaptopyrimidine**see *6-Benzyl-2-thiouracil*, NB67066 on page 118**N6-Benzyl-NECA**see *N6-Benzyl-5'-ethylcarboxamidoadenosine*, NB06327 on page 116**2,4-bis(Benzyloxy)-6-chloropyrimidine**

NB44331

Price On Application

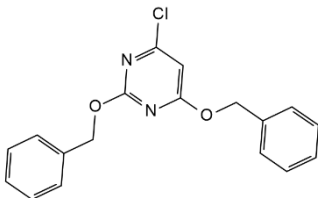
**8-Benzyloxy-2'-deoxyguanosine**[96964-90-8] C<sub>17</sub>H<sub>19</sub>N<sub>5</sub>O<sub>5</sub> 373.36

NB06296

5mg	\$90.00
10mg	\$150.00
25mg	\$300.00

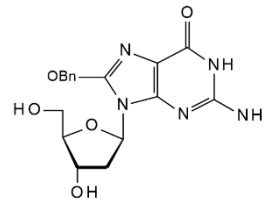

Refs: Torres MC, Varaprasad CV, Johnson F, et al, Carcinogenesis 1999, 20, 1, p167

**6-Benzylxypurine**[57500-07-9] C<sub>12</sub>H<sub>10</sub>N<sub>4</sub>O 226.23

NB11740

Price On Application

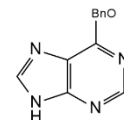
**4-(1-Benzylpiperidin-4-Ylamino)-2-(Methylthio)Pyrimidine-5-Carboxylic Acid**[1033194-54-5] C<sub>19</sub>H<sub>22</sub>N<sub>4</sub>O<sub>2</sub>S 358.46

NB57391

25mg	\$93.00
50mg	\$186.00
100mg	\$298.00

**2-Benzylthio-6-chloropurine**[51998-91-5] C<sub>15</sub>H<sub>9</sub>ClN<sub>4</sub>S 416.24

NB29023

Price On Application



**Benzylthiour****6-Benzyl-2-thiouracil**

• 6-Benzyl-4-hydroxy-2-mercaptopyrimidine

[6336-50-1] C<sub>11</sub>H<sub>10</sub>N<sub>2</sub>OS 218.279

NB67066	250mg	\$57.50
	500mg	\$90.00
	1g	\$144.00

**Biotin-5-cytidine-5'-triphosphate lithium salt - 1 mM aqueous solution**

• Biotin-5-CTP

C<sub>22</sub>H<sub>35</sub>N<sub>6</sub>O<sub>16</sub>P<sub>3</sub>S·xLi 764.53 (free acid basis)

NB32057	250ug	\$375.00
	500ug	\$625.00
	750ug	\$787.50

**Biotin-16-AA-CTP**see *Biotin-16-cytidine-5'-triphosphate lithium salt - 1 mM aqueous solution, NB32055 on page 118***Biotin-11-CTP.Li**see *Biotin-11-cytidine-5'-triphosphate lithium salt - 1 mM aqueous solution, NB32056 on page 118***Biotin-5-CTP**see *Biotin-5-cytidine-5'-triphosphate lithium salt - 1 mM aqueous solution, NB32057 on page 118***Biotin-11-cytidine-5'-triphosphate lithium salt - 1mM aqueous solution**

• Biotin-11-CTP.Li

C<sub>28</sub>H<sub>46</sub>N<sub>7</sub>O<sub>17</sub>P<sub>3</sub>S·xLi 877.69 (free acid basis)

NB32056	800ug	\$800.00
---------	-------	----------

**Biotin-16-cytidine-5'-triphosphate lithium salt - 1 mM aqueous solution**

• Biotin-16-AA-CTP

C<sub>32</sub>H<sub>52</sub>N<sub>8</sub>O<sub>18</sub>P<sub>3</sub>S 961.79

NB32055	1mg	\$795.00
---------	-----	----------

**Biotin-18-cytidine-5'-triphosphate triethylammonium salt - 5mM aqueous solution**C<sub>34</sub>H<sub>55</sub>N<sub>8</sub>O<sub>18</sub>P<sub>3</sub>S 988.83

NB46238	250ug	\$375.00
---------	-------	----------

**Biotin-11-dCTP**see *Biotin-11-deoxycytidine-5'-triphosphate, lithium salt - 1 mM aqueous solution, NB32062 on page 118***Biotin-16-dCTP**see *Biotin-16-deoxycytidine-5'-triphosphate, lithium salt - 1 mM aqueous solution, NB32061 on page 119***Biotin-5-dCTP**see *Biotin-5-deoxycytidine-5'-triphosphate, lithium salt - 1 mM aqueous solution, NB32078 on page 119***Biotin-11-deoxycytidine-5'-triphosphate, lithium salt - 1 mM aqueous solution**

• Biotin-11-dCTP

C<sub>28</sub>H<sub>46</sub>N<sub>7</sub>O<sub>16</sub>P<sub>3</sub>S 861.69

NB32062	800ug	\$720.00
---------	-------	----------



**Biotin-16-deoxycytidine-5'-triphosphate, lithium salt - 1 mM aqueous solution**

## • Biotin-16-dCTP

C<sub>32</sub>H<sub>53</sub>N<sub>6</sub>O<sub>17</sub>P<sub>3</sub>S 946.79

NB32061 1mg \$750.00

**Biotin-5-deoxycytidine-5'-triphosphate, lithium salt - 1 mM aqueous solution**

## • Biotin-5-dCTP

C<sub>22</sub>H<sub>35</sub>N<sub>6</sub>O<sub>15</sub>P<sub>3</sub>S 748.53

NB32078 800ug \$880.00

**Biotin-16-deoxyuridine-5'-triphosphate, lithium salt - 1 mM aqueous solution**

## • Biotin-16-dUTP

C<sub>32</sub>H<sub>52</sub>N<sub>7</sub>O<sub>18</sub>P<sub>3</sub>S·xLi 947.78 (free acid basis)

NB32058 1mg \$625.00

**Biotin-5-deoxyuridine-5'-triphosphate, lithium salt - 1 mM aqueous solution**

## • Biotin-5-dUTP

C<sub>22</sub>H<sub>34</sub>N<sub>6</sub>O<sub>16</sub>P<sub>3</sub>S·xLi 749.52 (free acid basis)

NB32060 Price On Application

**Biotin-11-2-deoxyuridine-5-triphosphate tetralithium salt**C<sub>24</sub>H<sub>41</sub>N<sub>6</sub>O<sub>17</sub>P<sub>3</sub>S·4Li 886.41

NB09511 1mg \$3150.00

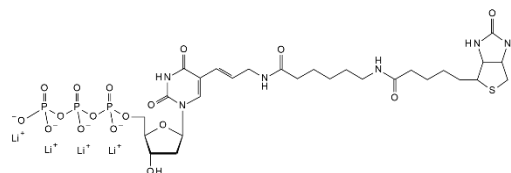
**Biotin-11-deoxyuridine-5'-triphosphate, triethylammonium salt - 1 mM aqueous solution**

## • Biotin-11-dUTP

C<sub>34</sub>H<sub>56</sub>N<sub>7</sub>O<sub>18</sub>P<sub>3</sub>S 975.83NB32059 1mg \$350.00  
2mg \$690.00  
5mg \$1650.00**Biotin-11-dUTP**see *Biotin-11-deoxyuridine-5'-triphosphate, triethylammonium salt - 1 mM aqueous solution, NB32059* on page 119**Biotin-16-dUTP**see *Biotin-16-deoxyuridine-5'-triphosphate, lithium salt - 1 mM aqueous solution, NB32058* on page 119**Biotin-5-dUTP**see *Biotin-5-deoxyuridine-5'-triphosphate, lithium salt - 1 mM aqueous solution, NB32060* on page 119**Biotin-11-uridine-5'-triphosphate, lithium salt - 1 mM aqueous solution**

## • Biotin-11-UTP

C<sub>29</sub>H<sub>45</sub>N<sub>6</sub>O<sub>16</sub>P<sub>3</sub>S·xLi 878.67 (free acid basis)

NB32053 Price On Application



**Biotinuridin****Biotin-16-uridine-5'-triphosphate, lithium salt - 1 mM aqueous solution**

## • Biotin-16-UTP

C<sub>32</sub>H<sub>52</sub>N<sub>7</sub>O<sub>19</sub>P<sub>3</sub>S·xLi 963.78 (free acid basis)

Price On Application

NB32052

**Biotin-5-uridine-5'-triphosphate, lithium salt - 1 mM aqueous solution**

## • Biotin-5-UTP

C<sub>22</sub>H<sub>34</sub>N<sub>5</sub>O<sub>17</sub>P<sub>3</sub>S·xLi 765.52 (free acid basis)

Price On Application

NB32054

**Biotin-18-uridine-5'-triphosphate triethylammonium salt - 5mM aqueous solution**

## • Biotin-18-UTP

C<sub>33</sub>H<sub>53</sub>N<sub>7</sub>O<sub>19</sub>P<sub>3</sub>S 976.8

Price On Application

NB46239

**Biotin-11-UTP**see *Biotin-11-uridine-5'-triphosphate, lithium salt - 1 mM aqueous solution, NB32053 on page 119***Biotin-16-UTP**see *Biotin-16-uridine-5'-triphosphate, lithium salt - 1 mM aqueous solution, NB32052 on page 120***Biotin-18-UTP**see *Biotin-18-uridine-5'-triphosphate triethylammonium salt - 5mM aqueous solution, NB46239 on page 120***Biotin-5-UTP**see *Biotin-5-uridine-5'-triphosphate, lithium salt - 1 mM aqueous solution, NB32054 on page 120***12-N-biotinyl(aminododecanoyl) Coenzyme A ammonium salt**see *Biotinyl coenzyme A, NB63246 on page 120***Biotinyl coenzyme A**

## • 12-N-biotinyl(aminododecanoyl) Coenzyme A ammonium salt

C<sub>43</sub>H<sub>82</sub>N<sub>13</sub>O<sub>19</sub>P<sub>3</sub>S<sub>2</sub> 1242.24

NB63246

1mg	\$495.00
2mg	\$970.00
5mg	\$1875.00

**8-(4-Biphenylamino)-2'-deoxyguanosine**see *N-(2'-Deoxyguanosin-8-yl)-4-amino(biphenyl), ND11672 on page 207***2,4-Bis(benzyloxy)-5-bromopyrimidine**see *5-Bromo-2,4-di(benzyloxy)pyrimidine, NB57419 on page 126***3',5'-Bis-O-(tert-butylidimethylsilyl)-5-bromo-2'-deoxyuridine**

## • 5-Bromo-2'-deoxy-3',5'-bis-O-[(1,1-dimethylethyl)dimethylsilyl]-uridine

[154925-95-8] C<sub>21</sub>H<sub>39</sub>BrN<sub>2</sub>O<sub>5</sub>Si<sub>2</sub> 535.62

NB16512

50mg	\$125.00
100mg	\$227.00
250mg	\$412.50

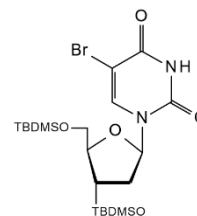

**3',5'-Bis-O-(tert-butyl dimethylsilyl)-2'-deoxyuridine**

• 2'-Deoxy-3',5'-bis-O-[(1,1-dimethylethyl)dimethylsilyl]uridine

[64911-18-8] C<sub>21</sub>H<sub>40</sub>N<sub>2</sub>O<sub>5</sub>Si<sub>2</sub> 456.72

NB18821

25mg	\$124.00
50mg	\$226.00
100mg	\$410.00

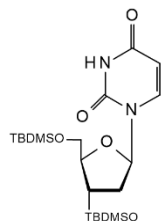

Refs: Zhang, W, et al. Chem. Res. Toxicol, 8, 148 (1995)

**1-[3,5-Bis-O-(4-chlorobenzoyl)-2-deoxy-a-D-erythro-pentofuranosyl]-5-fluoro-2,4(1H,3H)-pyrimidinedione**

see 3',5'-Di-O-p-chlorobenzoyl-2'-deoxy a-5-fluorouridine, ND22464 on page 236

**7-[3,5-Bis-O-[(2,4-dichlorophenyl)methyl]-2-C-methyl-b-D-ribofuranosyl]-4-chloro-5-iodo-7H-pyrrolo[2,3-d]pyrimidine**

[847551-25-1]

NB14088

Price On Application

**7-[3,5-Bis-O-[(2,4-dichlorophenyl)methyl]-2-C-methyl-beta-D-ribofuranosyl]-4-chloro-5-methyl-7H-pyrrolo[2,3-d]pyrimidine**

[443642-54-4]

NB14091

Price On Application

**7-[5-O-[Bis(4-methoxyphenyl)phenylmethyl]-2-deoxy-.beta.-D-erythro-pentofuranosyl]-1H-pyrrolo[2,3-d]pyrimidine-2,4(3H,7H)-dione**

see 7-Deaza-2'-deoxy-5'-O-DMT-xanthosine, ND10364 on page 165

**5'-O-[Bis(4-methoxyphenyl)phenylmethyl]-2'-deoxy-N-[2-[4-(1-methylethyl)phenoxy]acetyl]guanosine**

see 2'-Deoxy-5'-O-DMT-N2-(4-isopropylphenoxyacetyl)guanosine, ND156947 on page 187

**5'-O-[Bis(4-methoxyphenyl)phenylmethyl]-2'-deoxy-N-(2-phenoxyacetyl)adenosine**

see 2'-Deoxy-5'-O-DMT-N6-phenoxyacetyladenosine, ND08050 on page 188

**5'-O-[Bis(4-methoxyphenyl)phenylmethyl]-2'-O-(2-methoxyethyl)-N-(2-methyl-1-oxopropyl)guanosine**

see 5'-O-DMT-N2-isobutyryl-2'-O-(2-methoxyethyl)guanosine, ND31620 on page 259

**2',3'-Bis-S-(9-phenyl-9H-xanthen-9-yl)-2',3'-dithio-uridine**

see 2',3'-Di(9-phenylxanthen-9-yl)dithiouridine, ND16531 on page 253

**6-Bn-ADP**

see N6-Benzyladenosine 5'-O-diphosphate sodium salt, NB45915 on page 114

**N-Boc-5'-chloro-5'-deoxy-2,3-O-isopropylideneadenosine**

NB46266

Price On Application

**3-N-Boc-5'-O-dimethoxytrityl-3'-fluorothymidine**

[138685-99-1]

NB14259

Price On Application



**BocDMTnosylt****3-N-Boc-5'-O-DMT-3'-O-nosylthymidine**

• 1-(2-Deoxy-3-O-(4-nitrobenzenesulfonyl)-5-O-DMT-b-D-ribofuranosyl)-3-(tert-butylloxycarbonyl)thymine

[444717-23-1] C<sub>42</sub>H<sub>43</sub>N<sub>5</sub>O<sub>13</sub>S 829.87

NB09438	100mg	\$1050.00
	250mg	\$1812.50
	500mg	\$3250.00

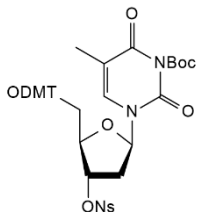

Refs: Mosdzianowski C, et.al, Eur. J. Med, 2001, 28, p1228

**BODIPY FL ATP-gamma-S thioester**

see Adenosine 5'-O-(3-thiotriphosphate), BODIPY FL thioester sodium salt - 5mM buffered aqueous solution, NA58152 on page 26

**Br-cADP-ribose**

see 8-Bromocyclic adenosine diphosphate ribose sodium salt, NB05042 on page 123

**5Br-dUDP**

see 5-Bromo-2'-deoxyuridine 5'-diphosphate sodium salt - 10mM aqueous solution, NB31485 on page 125

**5-BrdUMP . 2Na**

see 5-Bromo-2'-deoxyuridine-5'-monophosphate sodium salt, NB09916 on page 125

**5Br-dUTP**

see 5-Bromo-2'-deoxyuridine-5'-triphosphate sodium salt, NB31486 on page 125

**8-Br-5'-GMP**

see 8-Bromoguanosine-5'-monophosphate, NB71641 on page 127

**Brivudine**

see 5-(E)-(2-Bromovinyl)-2'-deoxyuridine, NB03851 on page 129

**8-Bromoadenine-9-b-D-ribofuranoside**

see 8-Bromoadenosine, NB03414 on page 123

**8-Bromoadenosine 3',5'-cyclic monophosphate sodium salt**

[76939-46-3] C<sub>10</sub>H<sub>10</sub>BrN<sub>5</sub>O<sub>8</sub>P·Na 430.08

NB07971

10mg	\$75.00
25mg	\$162.50
50mg	\$275.00

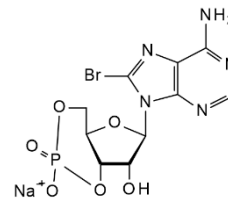
**8-Bromoadenosine 3',5'-cyclic monophosphate**

[23583-48-4] C<sub>10</sub>H<sub>11</sub>BrN<sub>5</sub>O<sub>8</sub>P 408.11

NB07972

50mg	\$90.00
100mg	\$150.00
250mg	\$250.00

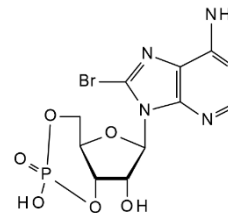
**8-Bromoadenosine 3',5'-cyclic monophosphorothioate, Rp-isomer sodium salt**

• Rp-8-Br-cAMPS

[129735-00-8] C<sub>10</sub>H<sub>10</sub>BrN<sub>5</sub>O<sub>5</sub>PS·Na 446.15

NB13568

1mg	\$250.00
2mg	\$390.00
5mg	\$900.00

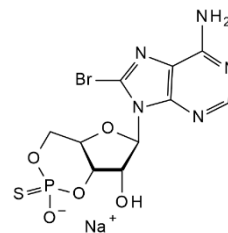

**8-Bromoadenosine 3',5'-cyclic monophosphorothioate, Sp-isomer sodium salt**

• Sp-8-Br-cAMP

[127634-20-2] C<sub>10</sub>H<sub>10</sub>BrN<sub>5</sub>O<sub>9</sub>PS-Na 446.51

NB08953

1mg	\$260.00
2mg	\$420.00
5mg	\$750.00

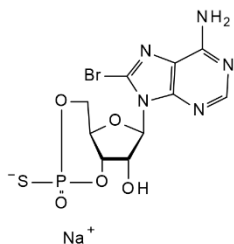
**6-Bromo-4-chloropyrido[2,3-d]pyrimidine**

[1215787-31-7]

NB44335

Price On Application

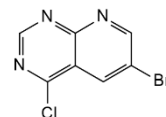
**5-Bromo-2-cyano-3-nitropyridine**

• 5-Bromo-3-nitropyridine-2-carbonitrile

[573675-25-9] C<sub>6</sub>H<sub>2</sub>BrN<sub>3</sub>O<sub>2</sub> 228

NB67409

25g	\$50.00
50g	\$95.00
100g	\$180.00

**2-Bromoadenosine**[146-76-9] C<sub>10</sub>H<sub>12</sub>BrN<sub>5</sub>O<sub>4</sub> 346.14

NB08372

2mg	\$160.00
5mg	\$300.00
10mg	\$450.00

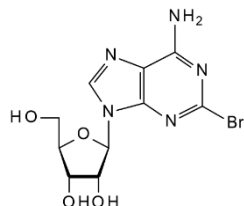
**8-Bromoadenosine**

- 6-Amino-8-bromopurine riboside
- 8-Bromoadenine-9-b-D-ribofuranoside

[2946-39-6] C<sub>10</sub>H<sub>12</sub>BrN<sub>5</sub>O<sub>4</sub> 346.14

NB03414

1g	\$47.30
2g	\$73.50
5g	\$157.50

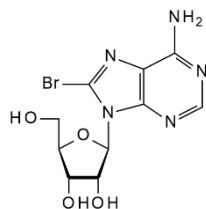

Refs: Ikehara M, Uesugi S, Chem. Pharm. Bull. 1969

**8-Bromocyclic adenosine diphosphate ribose sodium salt**

• Br-cADP-ribose

[151898-26-9] C<sub>15</sub>H<sub>19</sub>BrN<sub>5</sub>NaO<sub>13</sub>P<sub>2</sub> 642.19

NB05042

300ug	\$207.00
600ug	\$318.00
900ug	\$378.00

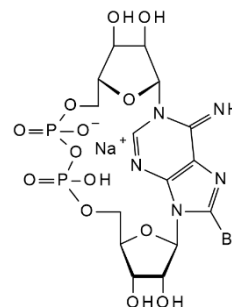

**Bromocytidin****5-Bromocytidine**[3066-86-2] C<sub>9</sub>H<sub>12</sub>BrN<sub>3</sub>O<sub>5</sub> 322.11

NB06281

500mg	\$80.00
1g	\$105.00
2g	\$178.50

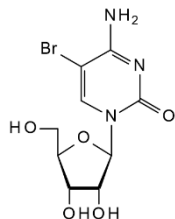

Refs: Ferrer E, Wiersma M, Kazimierczak B, Bioconjugate Chem. 1997, Vol8, No5, p757-761

**8-Bromo-2'-deoxyadenosine**[14985-44-5] C<sub>10</sub>H<sub>12</sub>BrN<sub>5</sub>O<sub>3</sub> 330.14

NB05283

250mg	\$50.00
500mg	\$90.00
1g	\$155.00

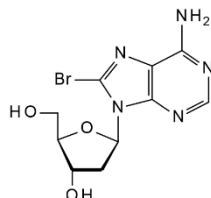

Refs: Guy AC, Duplaa AM, Harel P, et al, Helv. Chim. Acta 1988, Vol71, Issue 6, p1566-1572

**5-Bromo-2'-deoxycytidine**[1022-79-3] C<sub>9</sub>H<sub>12</sub>BrN<sub>3</sub>O<sub>4</sub> 306.11

NB06450

500mg	\$55.00
1g	\$90.00
2g	\$150.00

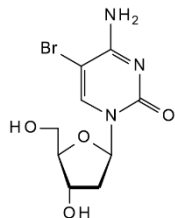

Refs: Sanders PG, Wilkie NM, Davison AJ, J. Gen. Virol. 1982, Vol63, p277-295

**5-Bromo-2'-deoxy-3',5'-bis-O-[(1,1-dimethylethyl)dimethylsilyl]-uridine**

see 3',5'-Bis-O-(tert-butyl)dimethylsilyl)-5-bromo-2'-deoxyuridine, NB16512 on page 120

**5-Bromo-2'-deoxy-5'-O-DMT-uridine**C<sub>30</sub>H<sub>29</sub>BrN<sub>2</sub>O<sub>7</sub> 609.48

NB08371

250mg	\$92.50
500mg	\$160.00
1g	\$294.00

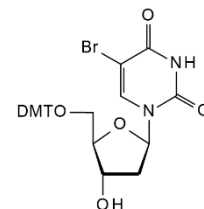
**5-Bromo-2'-deoxy-2'-fluorouridine**

NB15625

Price On Application

**8-Bromo-2'-deoxyguanosine**[13389-03-2] C<sub>10</sub>H<sub>12</sub>BrN<sub>5</sub>O<sub>4</sub> 346.14

NB05782

500mg	\$75.00
1g	\$135.00
2g	\$250.00

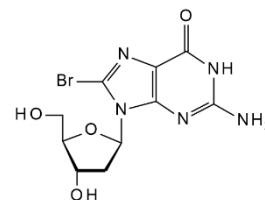

Refs: Esposito et al, Org. Biomol. Chem, 2004, 2, p313; Lin J, Med. Chem, 1985, 28, p1194

**2'-Bromo-2'-deoxy-3'-O-methanesulfonyluridine**

NB15687

25mg	\$367.50
50mg	\$630.00
100mg	\$1050.00





**2-Bromo-2'-deoxy-5-methyluridine-3,5-diacetate**

NB02564

Price On Application

**8-Bromo-2'-deoxy-6-O-(phenylmethyl)-3',5'-O-[1,1,3,3-tetrakis(1-methylethyl)-1,3-disiloxanediyl]guanosine**see *O6-Benzyl-8-bromo-3',5'-O(1,1,3,3-tetrakis(isopropyl)-1,3-disiloxanediyl)2'-deoxyguanine*, NB18375 on page 115**5-Bromo-2'-deoxy-4-thiouridine**

[676556-11-9]

NB63589

Price On Application

**5-Bromo-deoxyuridine CPG**

NB11641

10mg	\$50.00
25mg	\$75.00
50mg	\$100.00

**5-Bromo-2'-deoxyuridine 5'-diphosphate sodium salt - 10mM aqueous solution**

• 5Br-dUDP

C<sub>8</sub>H<sub>13</sub>N<sub>2</sub>O<sub>11</sub>P<sub>2</sub>B 397.96

NB31485

0.7mg \$595.00

**5-Bromo-2'-deoxyuridine-5'-monophosphate sodium salt**

• 5-BrdUMP. 2Na

[51432-32-7] C<sub>9</sub>H<sub>12</sub>BrN<sub>2</sub>O<sub>8</sub>PNa<sub>2</sub> 433.06

NB09916

50mg	\$50.00
100mg	\$80.00
250mg	\$150.00

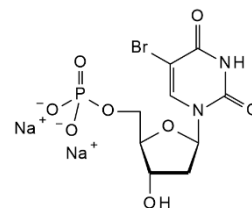
**5-Bromo-2'-deoxyuridine-5'-triphosphate sodium salt**

• 5Br-dUTP

C<sub>9</sub>H<sub>14</sub>N<sub>2</sub>O<sub>14</sub>P<sub>3</sub>Br 547.04

NB31486

5mg \$600.00

**2'-Bromo-2'-deoxyuridine**

• 2'-Bromo-D-uridine

[4753-02-0][72218-68-9] C<sub>9</sub>H<sub>11</sub>BrN<sub>2</sub>O<sub>5</sub> 307.1

NB02946

100mg	\$58.00
200mg	\$74.00
500mg	\$160.00

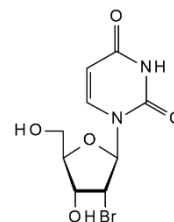

Refs: Robins MJ, Jones RA, Mengel R, J. Am. Chem. Soc. 1976, p8213



**Bromodeoxyur****5-Bromo-2'-deoxyuridine**

• 2'-Deoxy-5-bromouridine

[59-14-3] C<sub>9</sub>H<sub>11</sub>BrN<sub>2</sub>O<sub>5</sub> 307.1

NB06315	5g	\$95.00
	10g	\$170.00
	25g	\$315.00

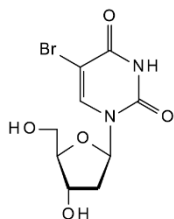

Refs: Bonhoeffer S, Mohri H, Ho D, et al, J. Immunology 2000, 164, 10, p5049-5054; Boccadoro M, et al, Tumor 1986, 72, p135

**5-Bromo-2,4-di(benzyloxy)pyrimidine**

• 2,4-Bis(benzyloxy)-5-bromopyrimidine

[41244-53-5] C<sub>18</sub>H<sub>15</sub>BrN<sub>2</sub>O<sub>2</sub> 371.23

NB57419	250mg	\$85.00
	500mg	\$135.00
	1g	\$334.70

**4-Bromo-3,5-dichloropyridine**[343781-45-3] C<sub>5</sub>H<sub>2</sub>BrCl<sub>2</sub>N 226.89

NB67655	10g	\$52.80
	25g	\$122.50
	50g	\$196.00

**5-Bromo-2',3'-dideoxyuridine**

[28616-93-5]

NB02934

Price On Application

**5-Bromo-2-fluoronicotinic acid**

• 5-Bromo-2-fluoropyridine-3-carboxylic acid

[29241-66-5] C<sub>6</sub>H<sub>3</sub>BrFNO<sub>2</sub> 220

NB67359	2g	\$40.00
	5g	\$60.00
	10g	\$100.00

**5-Bromo-2-fluoropyridine-3-carboxylic acid**

see 5-Bromo-2-fluoronicotinic acid, NB67359 on page 126

**8-Bromo-GTP**

see 8-Bromoguanosine-5'-triphosphate sodium salt - 10 mM aqueous solution, NB143914 on page 127

**8-Bromoguanosine 3',5'-cyclic monophosphate sodium salt**[51116-01-9] C<sub>10</sub>H<sub>10</sub>BrN<sub>5</sub>NaO<sub>7</sub>P 446.08

NB07973	5mg	\$89.30
	10mg	\$157.50
	25mg	\$262.50

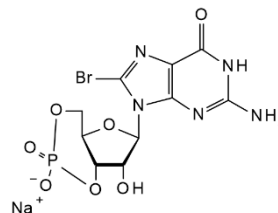
**8-Bromoguanosine hydrate**[332359-99-6] C<sub>10</sub>H<sub>12</sub>BrN<sub>5</sub>O<sub>5</sub>·xH<sub>2</sub>O 362.14 (anhydrous basis)

NB28930	2g	\$37.80
	5g	\$78.80
	10g	\$126.00



**8-Bromoguanosine-5'-monophosphate**

• 8-Br-5'-GMP

[21870-09-7] C<sub>10</sub>H<sub>13</sub>BrN<sub>5</sub>O<sub>8</sub>P 442.12

NB71641

Price On Application

**8-Bromoinosine**[55627-73-1] C<sub>10</sub>H<sub>11</sub>BrN<sub>4</sub>O<sub>5</sub> 347.13

NB08274

100mg	\$63.00
250mg	\$105.00
500mg	\$160.00

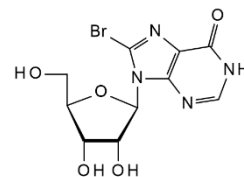
**8-Bromoguanosine-5'-triphosphate sodium salt - 10 mM aqueous solution**

• 8-Bromo-GTP

[23197-98-0] C<sub>10</sub>H<sub>15</sub>N<sub>5</sub>O<sub>14</sub>P<sub>3</sub>Br·xNa 602.08 (free acid basis)  
1.5mg

NB143914

\$525.00

**5-Bromo-2-(2-methoxyethylamino)pyrimidine**

[886365-79-3]

NB44319

Price On Application

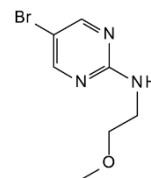
**8-Bromoguanosine**

• 2-Amino-8-bromo-6-hydroxypurine riboside

[4016-63-1] C<sub>10</sub>H<sub>12</sub>BrN<sub>5</sub>O<sub>5</sub> 362.14

NB06311

1g	\$50.00
2g	\$74.00
5g	\$100.00

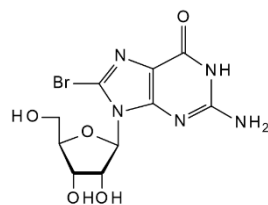

Refs: Scott JE, Zhang Pu, Hovatta O, Reproductive BioMedicine Online Vol8, No3, 03/2004, p319-324

**5-Bromo-2-(3-methoxypropylamino)pyrimidine**

[1189482-51-6]

NB44334

Price On Application

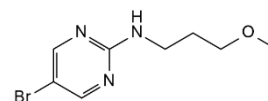
**4-Bromo-2-methoxypyrimidine**

[959240-72-3]

NB44324

Price On Application

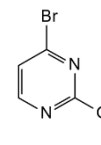

**Bromomethyla****8-Bromo-2'-O-methyladenosine**

NB145743

25mg	\$50.00
50mg	\$85.00
100mg	\$150.00

**2-Bromo-4-methylpyrimidine**

[130645-48-6]

NB44336

Price On Application

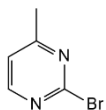
**5-Bromo-7-(2-C-methyl-b-D-ribofuranosyl)-7H-pyrrolo[2,3-d]pyrimidin-4-amine**

[443642-47-5]

NB14095

Price On Application

**5-Bromo-2-methylsulfanyl-pyrimidine-4-carboxylic acid**

[50593-92-5]

NB44268

5g	\$129.70
10g	\$207.50
25g	\$332.00

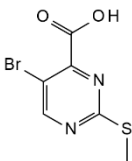
**5-Bromo-3-nitropyridine-2-carbonitrile**

see 5-Bromo-2-cyano-3-nitropyridine, NB67409 on page 123

**4-(4-Bromophenyl)pyrimidin-2-amine**

see 2-Amino-4-(4-bromophenyl)pyrimidine, NA57404 on page 39

**4-(4-Bromophenyl)pyrimidine-2-thiol**[832741-25-0] C<sub>10</sub>H<sub>7</sub>BrN<sub>2</sub>S 267.15

NB57410

250mg	\$95.00
500mg	\$150.00
1g	\$372.00

**5-Bromo-2,4-(1H,3H)-pyrimidinedione**

see 5-Bromouridine, NB03843 on page 129

**5-Bromopyrimidine-4,6(1H,5H)-dione**

[52176-13-3]

NB44313

Price On Application

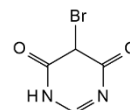
**8-Bromo-9-[3',5'-O-(1,1,3,3-tetraisopropyl-1,3-disiloxanediyl)-2'-deoxy-b-D-ribofuranosyl]guanine**C<sub>22</sub>H<sub>38</sub>BrN<sub>5</sub>O<sub>5</sub>Si<sub>2</sub> 588.64

NB04668

5mg	\$99.80
10mg	\$157.50
25mg	\$262.50

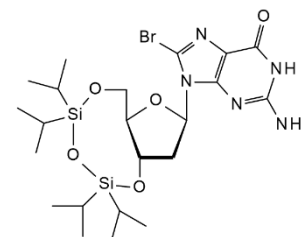
**5-Bromo-2',3',5'-tri-O-acetyluridine**

see 2',3',5'-Tri-O-acetyl-5-bromouridine, NT15543 on page 370

**2'-Bromo-D-uridine**

see 2'-Bromo-2'-deoxyuridine, NB02946 on page 125

**5-Bromouridine**

• 5-Bromo-2,4-(1H,3H)-pyrimidinedione

[957-75-5] C<sub>8</sub>H<sub>11</sub>BrN<sub>2</sub>O<sub>6</sub> 323.1

NB03843

1g	\$45.00
2g	\$70.00
5g	\$115.00

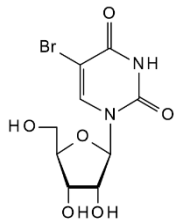

Refs: Haschemeyer AEV, Sobell HM, Acta Crystallogr. 1965, 18, p525-532

**5-(E)-(2-Bromovinyl)-2'-deoxyuridine**

• Brivudine

[69304-47-8] C<sub>11</sub>H<sub>13</sub>BrN<sub>2</sub>O<sub>5</sub> 333.14

NB03851

250mg	\$50.00
500mg	\$65.00
1g	\$90.00

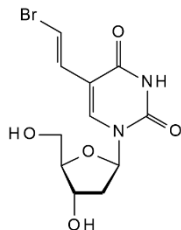
**Bucladesine calcium salt**

see N6,2'-O-Dibutyryladenine 3',5'-cyclic monophosphate calcium salt, NC11728 on page 235

**Bucladesine Na**

see N6,2'-O-Dibutyryladenine 3',5'-cyclic monophosphate sodium salt, ND07996 on page 235

**2-[[4-[2-(tert-Butoxycarbonyl)ethyl]phenylethyl]amino]2',3'-O-isopropylideneadenosine-5'-N-ethylcarboxamide**

• 4-[2-[[6-Amino-9-[N-ethyl-2,3-O-(1-methylethylidene)-b-D-ribofuranuronamidosyl]-9H-purin-2-yl]amino]ethyl]benzenepropanoic acid 1,1-dimethylethyl ester

[120225-76-5] C<sub>30</sub>H<sub>41</sub>N<sub>7</sub>O<sub>6</sub> 595.69

NB16642

5mg	\$70.00
10mg	\$127.20
25mg	\$231.50

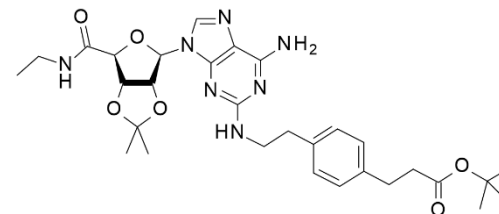
**2'-O-tert-Butyldimethylsilyladenine**

[69504-13-8]

NB15545

Price On Application

**3'-O-tert-Butyldimethylsilyladenine**

[69504-14-9]

NB15546

Price On Application



**Butyldimethyl****5'-O-tert-Butyldimethylsilyl-2,2'-anhydrouridine**C<sub>15</sub>H<sub>24</sub>N<sub>2</sub>O<sub>5</sub>Si 340.45

NB08205

Price On Application

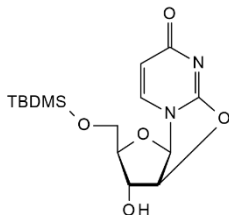
**5'-O-tert-Butyldimethylsilyl-2'-deoxy-5-iodouridine**C<sub>15</sub>H<sub>25</sub>I<sub>2</sub>N<sub>2</sub>O<sub>5</sub>Si 468.37

NB08643

500mg	\$95.00
1g	\$170.70
2g	\$325.50

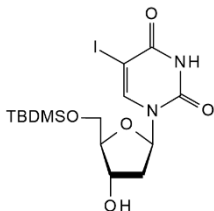
**2'-O-tert-Butyldimethylsilyl-3'-deoxy-5'-O-trityluridine**C<sub>34</sub>H<sub>40</sub>N<sub>2</sub>O<sub>5</sub>Si 584.78

NB07424

25mg	\$89.50
50mg	\$168.00
100mg	\$263.00

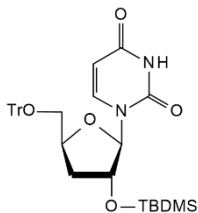

Refs: Lin TS, et.al, J. Med. Chem, 1991,34, p693

**2'-O-(tert-Butyldimethylsilyl)-3'-deoxy-5'-O-trityluridine**

• 3'-Deoxy-2'-O-[(1,1-dimethylethyl)dimethylsilyl]-5'-O-(triphenylmethyl)uridine

[130860-12-7] C<sub>34</sub>H<sub>40</sub>N<sub>2</sub>O<sub>5</sub>Si 584.78

NB16513

25mg	\$140.00
50mg	\$254.50
100mg	\$462.00

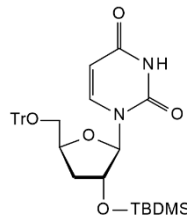

Refs: Lin, T-S, et al, J. Med. Chem, 34, 693 (1991)

**5'-O-tert-Butyldimethylsilyl-2'-deoxyuridine**C<sub>15</sub>H<sub>26</sub>N<sub>2</sub>O<sub>5</sub>Si 342.47

NB08646

Price On Application

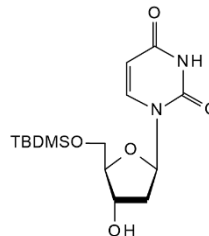
**5'-O-tert-Butyldimethylsilyl-2',3'-dideoxy-3'-fluorouridine**C<sub>15</sub>H<sub>25</sub>FN<sub>2</sub>O<sub>4</sub>Si 344.45

NB08272

Price On Application

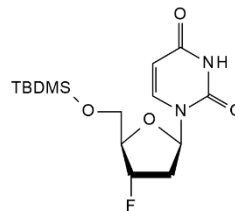

**2'-O-tert-Butyldimethylsilyl-5'-O-DMT-adenosine**

[81794-13-0]

NB15553	1g	\$385.00
	2g	\$750.00
	5g	\$1475.00

**3'-O-tert-Butyldimethylsilyl-5'-O-DMT-adenosine**

[81794-12-9]

NB15555	1g	\$645.00
	2g	\$1150.00
	5g	\$2250.00

**2'-O-tert-Butyldimethylsilyl-5'-O-DMT-N2-isobutyrylguanosine**

see 5'-O-(4,4'-Dimethoxytrityl)-2'-O-(tertbutyldimethylsilyl)-N-isobutyryl-Guanosine, ND57513 on page 250

**3'-O-tert-Butyldimethylsilyl-5'-O-DMT-N2-isobutyrylguanosine**

• 5'-DMT-3'-TBDMS-ibu-rG

C<sub>41</sub>H<sub>51</sub>N<sub>5</sub>O<sub>8</sub>Si 769.96

NB33744

Price On Application

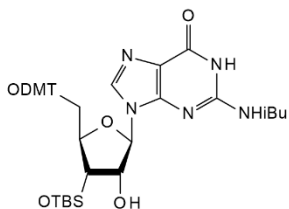
**2'-O-tert-Butyldimethylsilyl-5'-O-DMT-N6-(2-Isopentenyl)adenosine 3'-CE phosphoramidite**

NB139127

250mg	\$950.00
500mg	\$1500.00
1g	\$1950.00

**2'-O-tert-Butyldimethylsilyl-5'-O-DMT-C2-methyladenosine 3'-CE phosphoramidite**[1028723-99-0] C<sub>47</sub>H<sub>64</sub>N<sub>7</sub>O<sub>7</sub>Si 867.14

NB139123

250mg	\$950.00
500mg	\$1500.00
1g	\$1950.00

**2'-tert-Butyldimethylsilyl-5'-DMT-N6-methyladenosine**C<sub>38</sub>H<sub>47</sub>N<sub>5</sub>O<sub>6</sub>Si 697.9

ND57512

Price On Application

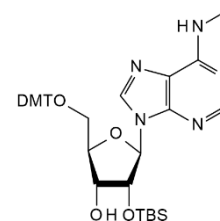
**2'-O-tert-Butyldimethylsilyl-5'-O-DMT-1-methylguanosine 3'-CE phosphoramidite**[1356084-46-2] C<sub>47</sub>H<sub>64</sub>N<sub>7</sub>O<sub>8</sub>PSi 914.11

NB139125

250mg	\$950.00
500mg	\$1500.00
1g	\$1950.00



**Butyldimethyl****2'-O-tert-Butyldimethylsilyl-5'-O-DMT-N2-methylguanosine 3'-CE phosphoramidite**

NB139128	250mg	\$950.00
	500mg	\$1500.00
	1g	\$1950.00

**2'-O-tert-Butyldimethylsilyl-5'-O-DMT-3-methyluridine 3'-CE phosphoramidite**[179762-50-6] C<sub>46</sub>H<sub>63</sub>N<sub>4</sub>O<sub>9</sub>PSi 875.07

NB139124	250mg	\$950.00
	500mg	\$1500.00
	1g	\$1950.00

**2'-O-tert-Butyldimethylsilyl-5'-O-DMT-uridine**[81246-80-2] C<sub>36</sub>H<sub>44</sub>N<sub>2</sub>O<sub>8</sub>Si 660.83

NB15303	1g	\$75.00
	2g	\$130.00
	5g	\$225.00

**3'-O-tert-Butyldimethylsilyl-5'-O-DMT-uridine**

• 5'-O-(4,4'-Dimethoxytrityl)-3'-O-tert-butyldimethylsilyl uridine

[81246-81-3] C<sub>36</sub>H<sub>44</sub>N<sub>2</sub>O<sub>8</sub>Si 660.83

NB33743

Price On Application

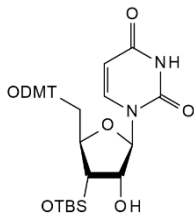
**2'-O-tert-Butyldimethylsilyl-N2-isobutrylguanosine**[182007-86-9] C<sub>20</sub>H<sub>33</sub>N<sub>5</sub>O<sub>6</sub>Si 467.59

NB57544

1g	\$60.00
2g	\$104.00
5g	\$225.00

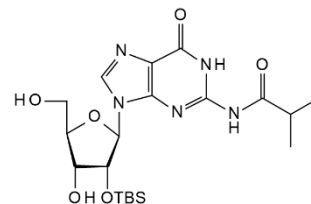
**9-(5'-O-t-Butyldimethylsilyl-2',3'-O-isopropylidene-b-D-ribofuranosyl)-6-chloro-7-deazaguanine**[115479-40-8] C<sub>20</sub>H<sub>33</sub>ClN<sub>4</sub>O<sub>4</sub>Si 457.04

NB10265

2mg	\$84.00
5mg	\$157.50
10mg	\$210.00

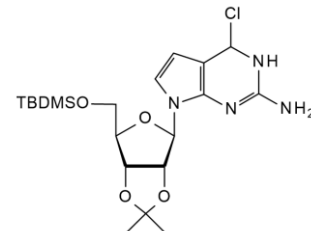
**2'-O-tert-Butyldimethylsilyl-5-methyluridine**[922508-26-7] C<sub>18</sub>H<sub>28</sub>N<sub>2</sub>O<sub>6</sub>Si 372.49

NT57546

Price On Application

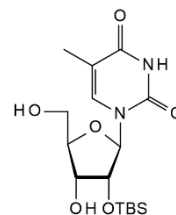



**2'-O-(tert-Butyldimethylsilyl)-3'-O-(phenoxythioncarbonyl)-5'-O-trityluridine**

• 2'-O-[(1,1-Dimethylethyl)dimethylsilyl]-5'-O-(triphenylmethyl)uridine 3'-O-phenyl carbonothioate

[130860-11-6] C<sub>41</sub>H<sub>44</sub>N<sub>2</sub>O<sub>7</sub>SSi 736.95

NB16514

25mg	\$110.00
50mg	\$200.50
100mg	\$364.00

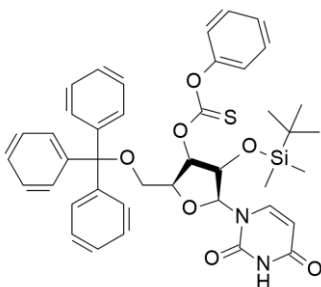

Refs: Lin, T-S, et al, J. Med. Chem. 34, 693 (1991)

**2'-O-tert-Butyldimethylsilyl-5'-O-trityluridine**

• 2'-O-[(1,1-Dimethylethyl)dimethylsilyl]-5'-O-(triphenylmethyl)uridine

[117136-35-3] C<sub>34</sub>H<sub>40</sub>N<sub>2</sub>O<sub>6</sub>Si 600.78

NB16515

50mg	\$110.50
100mg	\$201.00
250mg	\$365.00

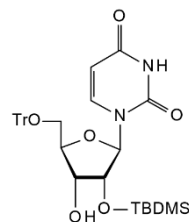

Refs: Lin, T-S, et al, J. Med. Chem. 34, 693 (1991)

**2'-O-tert-Butyldimethylsilyluridine**[54925-71-2] C<sub>15</sub>H<sub>26</sub>N<sub>2</sub>O<sub>6</sub>Si 358.46

NB46819

1g	\$1000.00
2g	\$1600.00
5g	\$2500.00

**5'-O-tert-Butyldimethylsilyl-D3-thymidine**C<sub>16</sub>H<sub>25</sub>N<sub>2</sub>O<sub>5</sub>SiD<sub>3</sub> 359.52

NB08944

Price On Application

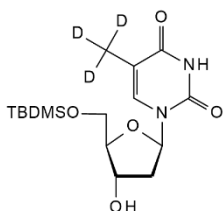
**5'-O-tert-Butyldimethylsilylthymidine**[40733-28-6] C<sub>16</sub>H<sub>26</sub>N<sub>2</sub>O<sub>5</sub>Si 356.5

NB08945

1g	\$125.00
2g	\$195.00
5g	\$275.00

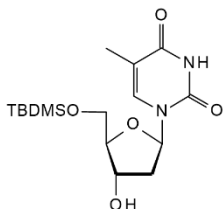
**5'-O-tert-Butyldimethylsilyluridine**

NB09608

Price On Application

**9-(5'-tert-Butyldiphenylsilyl-2'-deoxy-D-xylofuranosyl)guanine**

NB145599

Price On Application



**Butyldipheny****3'-O-tert-Butyldiphenylsilyl-2'-O-methyluridine**

NB64783

Price On Application

**5'-O-tert-Butylmethylsilyl-2'-deoxy-5-iodocytidine**[666848-11-9] C<sub>15</sub>H<sub>26</sub>IN<sub>3</sub>O<sub>4</sub>Si 467.38

NB08949

Price On Application

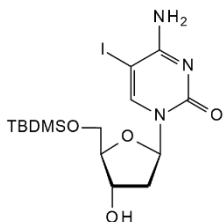
**2-tert-Butylpyrimidine-5-carbaldehyde**[104461-06-5] C<sub>9</sub>H<sub>12</sub>N<sub>2</sub>O 164.2

NB57438

50mg	\$65.00
100mg	\$104.00
250mg	\$127.50

**2-(Butylthio)pyrimidine-5-carbaldehyde**[915920-13-7] C<sub>9</sub>H<sub>12</sub>N<sub>2</sub>OS 196.27

NB57433

1g	\$81.40
2g	\$130.10
5g	\$323.00

**BzATP triethylammonium salt**

see 2'-(3'-O-(4-Benzoyl)benzoyl)adenosine-5'-triphosphate triethylammonium salt, NB29594 on page 94

**N4-Bz-5-Me-DMT-2'-O-Me-C**see *N4-Benzoyl-5'-O-DMT-2'-O-methyl-5-methylcytidine*, NB09205 on page 109**N6-Bz-3'-TBDMS-5'-DMT rA**see *N6-Benzoyl-3'-O-tert-butyltrimethylsilyl-5'-O-DMT-adenosine*, NB15524 on page 95**Caged GTP**

- Guanosine 5'-triphosphate P<sub>3</sub>-[1-(2-nitrophenyl)ethyl]ester
- Guanosine 5'-(tetrahydrogen triphosphate) P<sup>+</sup>-[1-(2-nitrophenyl)ethyl]ester

[124830-99-5] C<sub>18</sub>H<sub>23</sub>N<sub>6</sub>O<sub>16</sub>P<sub>3</sub> 672.33

NC19632

1mg	\$1102.50
2mg	\$1974.00
5mg	\$3570.00

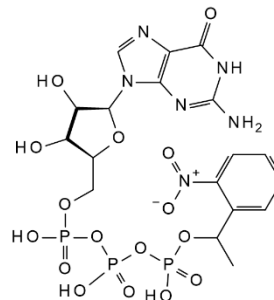

Refs: John, J, et al, J. Biol. Chem, 264, 13086

**Calcium dibutryladenosine cyclophosphate**see *N6,2'-O-Dibutryladenosine 3',5'-cyclic monophosphate calcium salt*, NC11728 on page 235**Calcium 5'-guanylate**see *Guanosine 5'-monophosphate calcium salt*, NG40772 on page 284**cAMP sodium salt**see *Adenosine 3',5'-cyclic monophosphate sodium salt*, NA08992 on page 21**cAMPS. TEA, Sp-isomer**see *Adenosine 3',5'-cyclic monophosphorothioate Sp-isomer triethylammonium salt*, NA08995 on page 22**cAMP TEA, Rp isomer**see *Adenosine 3',5'-cyclic monophosphothioate Rp-isomer triethylammonium salt*, NA08993 on page 22**cAMP**see *Adenosine 3',5'-cyclic monophosphate*, NA08991 on page 22

**Capecitabine 2',3'-cyclic carbonate**

• 5'-Deoxy-5-fluoro-N-[(pentyloxy)carbonyl]cytidine cyclic 2',3'-carbonate

[921769-65-5] C<sub>18</sub>H<sub>20</sub>FN<sub>3</sub>O<sub>7</sub> 385.34

NC16644

5mg	\$140.00
10mg	\$254.50
25mg	\$463.00

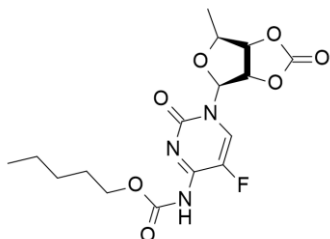
**Capecitabine**

see 5'-Deoxy-5-fluoro-N4-(pentyloxycarbonyl)cytidine, ND09160 on page 201

**Capectabine**

see 2',3'-Di-O-acetyl-5'-deoxy-5-fluorocytidine, ND05721 on page 227

**Capryl coenzyme A**

see Decanoyl coenzyme A, free acid, ND47196 on page 170

**Caprylyl coenzyme A**

see Octanoyl coenzyme A, NO47202 on page 337

**N6-Carbamoylthreonyl-adenosine sodium salt**[24719-82-2] C<sub>15</sub>H<sub>19</sub>N<sub>5</sub>O<sub>8</sub>·Na 434.34

NC06332

1mg	\$105.00
2mg	\$190.00
5mg	\$367.50

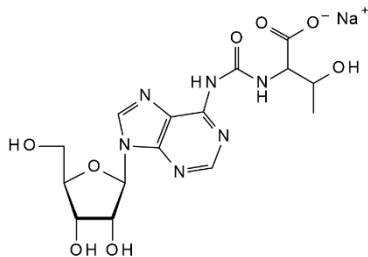

Refs: Morin et.al, RNA, 1998, 4, p24

**N2-Carbamoylthreonyl-2'-deoxyguanosine**

NC63100

Price On Application

**N2-Carbamoylthreonyl-2'-deoxyguanosine**

NC63104

Price On Application

**N2-Carbamoylthreonylguanosine sodium salt**

NC63113

Price On Application

**Carbocyclic adenosine**

- 9-(2,3-Dihydroxy-4-[hydroxymethyl]cyclopentyl)adenine
- Aristeromycin

[19186-33-5] C<sub>11</sub>H<sub>15</sub>N<sub>5</sub>O<sub>3</sub> 265.27

NC29204

Price On Application

**Carbocyclic cytidine**

see Carbodine, NC15795 on page 136

**Carbocyclic****Carbocyclic 2'-deoxyguanosine 5'-triphosphate**[118905-01-4] C<sub>11</sub>H<sub>16</sub>N<sub>5</sub>O<sub>8</sub>P 345.25

NC29202

Price On Application

**Carbocyclic 2'-deoxyguanosine**C<sub>11</sub>H<sub>15</sub>N<sub>5</sub>O<sub>3</sub> 265.27

NC29203

Price On Application

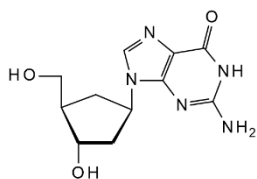
**Carbocyclic inosine**

- Coaristeromycin
- 9-[(1R,2S,3R,4R)-2,3-Dihydroxy-4-(hydroxymethyl)cyclopentyl]-3H-purin-6-one

[16975-94-3] C<sub>11</sub>H<sub>14</sub>N<sub>4</sub>O<sub>4</sub> 266.25

NC29205

Price On Application

**Carbodine**

- 4-amino-1-[(1R,2S,3R,4R)-2,3-dihydroxy-4-(hydroxymethyl)cyclopentyl]pyrimidin-2-one
- Carbocyclic cytidine

[71184-20-8] C<sub>10</sub>H<sub>15</sub>N<sub>3</sub>O<sub>4</sub> 241.24

NC15795

Price On Application



Refs: Bioorganic & Medicinal Chemistry Letters  
Volume 20, Issue 8, 15 April 2010, Pages 2601-2604.

**E-5-(2-Carbomethoxyvinyl)-2'-deoxy-5'-O-DMT-uridine**[869355-22-6] C<sub>34</sub>H<sub>34</sub>N<sub>2</sub>O<sub>9</sub> 614.66

NC08240

50mg	\$89.50
100mg	\$158.00
250mg	\$262.50

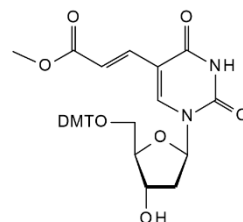
**E-5-(2-Carbomethoxyvinyl)-2'-deoxyuridine**[86163-17-9] C<sub>13</sub>H<sub>16</sub>N<sub>2</sub>O<sub>7</sub> 312.28

NC08275

250mg	\$70.00
500mg	\$100.00
1g	\$173.30

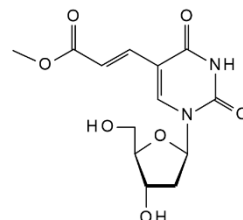
**Carbovir**

- rel-2-Amino-1,9-dihydro-9-[(1R,4S)-4-(hydroxymethyl)-2-cyclopenten-1-yl]-6H-purin-6-one

[118353-05-2] C<sub>11</sub>H<sub>13</sub>N<sub>5</sub>O<sub>2</sub> 247.25

NC16517

0.5mg	\$175.00
1mg	\$250.00
2mg	\$450.00

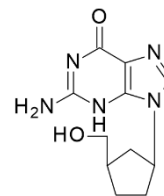

Refs: Suo, Z. et al, J. Biol. Chem, 273, 27250 (1998); Ray, A. et al, Antimicrob. Agents Chemother, 48, 1089 (2004); Lynx, M. et al, Biochem. Pharmacol, 71, 1342 (2006)

**5'-Carboxy-2-chloro-2'-3'-O-isopropylideneadenosine**

• 2-Chloroadenosine-5'-carboxy-2',3'-acetonide

[72209-20-2] C<sub>13</sub>H<sub>14</sub>ClN<sub>5</sub>O<sub>5</sub> 355.74

NC06333

25mg	\$75.00
50mg	\$118.50
100mg	\$205.00

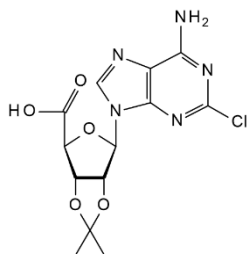
**5-Carboxy-2'-deoxyuridine**

• Trifluridine Related Compound A

[14599-46-3] C<sub>10</sub>H<sub>12</sub>N<sub>2</sub>O<sub>7</sub> 272.21

NC58344

1mg	\$195.00
2mg	\$370.00
5mg	\$750.00

**2-p-(2-Carboxyethyl)phenethylamino-5'-N-ethylcarboxamidoadenosine hydrochloride hydrate**

• CGS 21680 A Hydrochloride hydrate

[124182-57-6] C<sub>23</sub>H<sub>30</sub>ClN<sub>7</sub>O<sub>6</sub>·xH<sub>2</sub>O 535.98 (anhydrous basis)

NC10755

25mg	\$300.00
50mg	\$410.00
100mg	\$625.00

**2-p-(2-Carboxyethyl)phenethylamino-5'-N-ethylcarboxamidoadenosine hydrochloride**

- CGS 21680 hydrochloride
- 4-[2-[[6-Amino-9-(N-ethyl-b-D-ribofuranuronamidoyl)-9H-purin-2-yl]amino]ethyl]benzenepropanoic acid hydrochloride

[124431-80-7] C<sub>23</sub>H<sub>30</sub>ClN<sub>7</sub>O<sub>6</sub> 535.98

NC16650

1mg	\$65.00
2mg	\$95.00
5mg	\$125.00

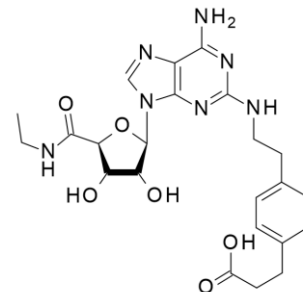

ClH



Refs: Baggolini, M, et al, J. Clin. Invest, 84, 1045 (1989); Kainoh, M, et al, Biochem. Pharmacol, 39, 477 (1990); Bouma, M, et al, J. Immunol, 153, 4159 (1994); Ollivier, V, et al, J. Biol. Chem, 271, 20828 (1996)

**5'-Carboxy-2-iodo-2',3'-O-isopropylideneadenosine**

- 2-Iodoadenosine 5'-carboxy-2',3'-acetonide
- 2-Iodo-9-(2,3-O-isopropylidene-b-D-ribofuranosyl uronic acid)adenine

[141018-26-0] C<sub>13</sub>H<sub>14</sub>I<sub>2</sub>N<sub>5</sub>O<sub>5</sub> 447.19

NC05725

5mg	\$89.30
10mg	\$168.00
25mg	\$262.50

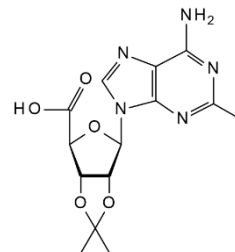

**Carboxyisopr****5'-Carboxy-2',3'-O-isopropylideneadenosine**

• 2',3'-Isopropylideneadenosine-5'-carboxylic acid

[811431-33-1][19234-66-3] C<sub>13</sub>H<sub>15</sub>N<sub>5</sub>O<sub>5</sub> 321.3

NC07451

50mg	\$75.00
100mg	\$125.00
250mg	\$225.00

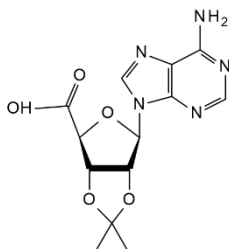
**N-Cbz gemcitabine**

- 2'-Deoxy-2',2'-difluoro-N-[(phenylmethoxy)carbonyl]-cytidine
- [1-(2-Deoxy-2,2-difluoro-b-D-erythro-pentofuranosyl)-1,2-dihydro-2-oxo-4-pyrimidinyl]-carbamic acid phenylmethyl ester

[138685-83-3] C<sub>17</sub>H<sub>17</sub>F<sub>2</sub>N<sub>3</sub>O<sub>6</sub> 397.33

NC16645

5mg	\$174.90
10mg	\$318.00
25mg	\$578.50

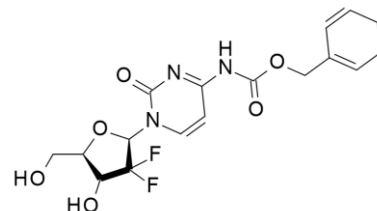
**3-Carboxy-1-b-D-ribofuranosylpyridinium salt**see *Nicotinic acid riboside*, NN16815 on page 335**E-5-(2-Carboxyvinyl)-2'-deoxyuridine hydroxysuccinimide ester**[869355-24-8] C<sub>16</sub>H<sub>17</sub>N<sub>3</sub>O<sub>9</sub> 395.32

NC10421

100mg	\$132.00
200mg	\$190.00
500mg	\$315.00

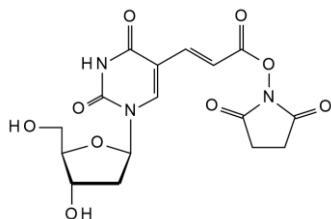
**1'-13CCytidine**[201996-57-8] <sup>13</sup>CC<sub>8</sub>H<sub>13</sub>N<sub>3</sub>O<sub>5</sub> 244.21

NC34301

25mg	\$194.50
50mg	\$304.50
100mg	\$494.00

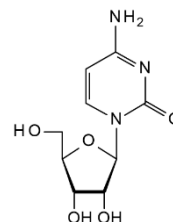
**2'-13CCytidine**[478511-19-2] <sup>13</sup>CC<sub>8</sub>H<sub>13</sub>N<sub>3</sub>O<sub>5</sub> 244.21

NC34302

50mg	\$350.00
100mg	\$570.00

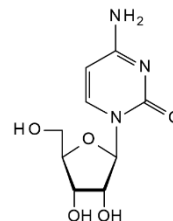
**E-5-(2-Carboxyvinyl)-2'-deoxyuridine**[74131-06-9] C<sub>12</sub>H<sub>14</sub>N<sub>2</sub>O<sub>7</sub> 298.25

NC08239

100mg	\$90.00
250mg	\$157.50
500mg	\$265.00

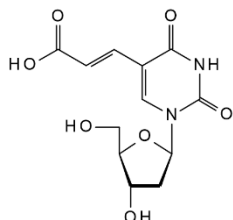
**CDP-choline sodium salt**see *Citicoline sodium salt*, NC05679 on page 153

**CDP-ethanolamine disodium salt**see *Cytidine 5'-diphosphate ethanolamine disodium salt, NC28916 on page 160***c-GpAp sodium salt**see *3',3'-Cyclic GAMP, NC137624 on page 157***CGS 21680 A Hydrochloride hydrate**see *2-p-(2-Carboxyethyl)phenethylamino-5'-N-ethylcarboxamidoadenosine hydrochloride hydrate, NC10755 on page 137***CGS 21680 hydrochloride**see *2-p-(2-Carboxyethyl)phenethylamino-5'-N-ethylcarboxamidoadenosine hydrochloride, NC16650 on page 137***2-Chloroadenosine-2',3'-acetonide**see *2-Chloro-2',3'-O-isopropylideneadenosine, NC06329 on page 148***2-Chloroadenosine-5'-carboxy-2',3'-acetonide**see *5'-Carboxy-2-chloro-2',3'-O-isopropylideneadenosine, NC06333 on page 137***8-Chloroadenosine 3',5'-cyclic monophosphate dihydrate**[41941-56-4]  $C_{10}H_{11}ClN_5O_6P \cdot 2H_2O$  399.69

NC10381

5mg	\$325.00
10mg	\$600.00
25mg	\$1400.00

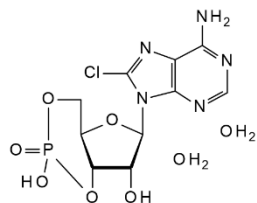
**8-Chloroadenosine 3',5'-cyclic monophosphate**

• 8-Cl-cAMP

[41941-56-4]  $C_{10}H_{11}ClN_5O_6P$  363.65

NC10380

1mg	\$78.80
2mg	\$126.00
4mg	\$210.00

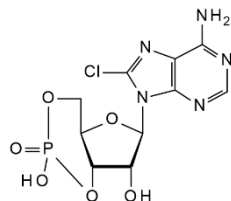
**2-Chloroadenosine hemihydrate**[81012-94-4]  $C_{10}H_{12}ClN_5O_4 \cdot \frac{1}{2}H_2O$  310.69

NC04681

2g	\$42.00
5g	\$78.80
10g	\$105.00

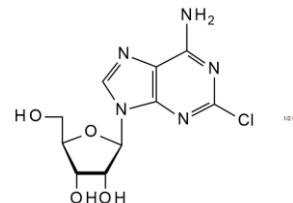
**2-Chloroadenosine 5'-monophosphate triethylamine salt**[21466-01-3]  $C_{10}H_{13}ClN_5O_7P \cdot C_{12}H_{30}N_2$  584.05

NC10383

2mg	\$117.60
5mg	\$262.50
10mg	\$472.50

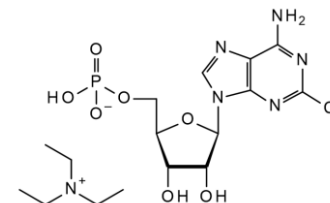
**8-Chloroadenosine-5'-monophosphate**

• 8-Cl-5'-AMP

[37676-40-7]  $C_{10}H_{13}ClN_5O_7P$  381.67

NC71639

Price On Application

**2-Chloro-adenosine 2',3',5'-triacetate**see *2',3',5'-Tri-O-acetyl-2-chloroadenosine, NT20146 on page 370*

**Chloroadenos****2-Chloroadenosine**

• 6-Amino-2-chloropurine riboside

[146-77-0] C<sub>10</sub>H<sub>12</sub>ClN<sub>5</sub>O<sub>4</sub> 301.69

NC06293

1g	\$52.50
2g	\$73.50
5g	\$140.00

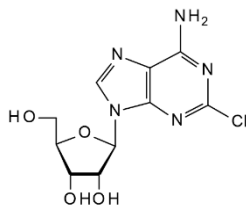

Refs: Yavuz O, Tuerkoezkan N, Bilgihan A, et al, Free Radical Biol. Med. 1997, 22, p337; Evans, et al, Neurosci. Lett. 1987, 83, p287; Szondy Z, Biochem. J. 1994, 304, p877

**8-Chloroadenosine**[34408-14-5] C<sub>10</sub>H<sub>12</sub>ClN<sub>5</sub>O<sub>4</sub> 301.69

NC03343

1mg	\$89.30
2mg	\$157.50
5mg	\$262.50

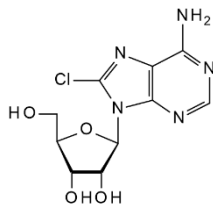

Refs: Chen LS, Sheppard TL, Nucleosides Nucleotides And Nucleic Acids 2002, Vol21, Pt8/9, p599-617; Choo-Chung et.al, Cancer Invest, 1989, 7, p161

**2-Chloro-6-amino-purine-2'-fluoro-2'-deoxy arabinoside**

see 6-Amino-2-chloro-9-(2'-deoxy-2'-fluoro-b-D-arabinofuranosyl)purine, NA07154 on page 40

**4-Chloro-5-aminopyrimidine**

• 4-Chloropyrimidin-5-amine

[54660-78-5] C<sub>4</sub>H<sub>4</sub>ClN<sub>3</sub> 129.55

NC57423

500mg	\$80.00
1g	\$217.90
2g	\$429.00

**2-Chloro-6-amino-9-(2',3',5'-tri-O-acetyl-b-D-ribofuranosyl)purine**

see 6-Amino-2-chloro-9-(2',3',5'-tri-O-acetyl-b-D-ribofuranosyl)purine, NA05212 on page 43

**5-Chloro-1-(b-D-arabinofuranosyl)cytidine**[17676-65-2] C<sub>9</sub>H<sub>12</sub>ClN<sub>3</sub>O<sub>5</sub> 277.66

NC07979

25mg	\$375.00
50mg	\$550.00
100mg	\$900.00

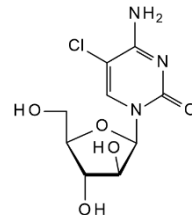
**2-Chloro-4-cyanopyrimidine**

see 2-Chloro-4-pyrimidinecarbonitrile, NC57397 on page 152

**2-Chloro-N6-cyclopentyladenosine hemihydrate**[37739-05-2] C<sub>15</sub>H<sub>20</sub>ClN<sub>5</sub>O<sub>4</sub>·½H<sub>2</sub>O 378.81

NC07978

2mg	\$70.00
5mg	\$150.00
10mg	\$250.00

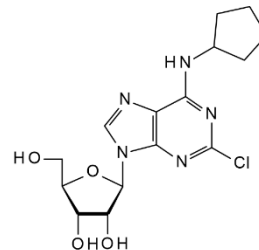
**5-Chlorocytidine**[25130-29-4] C<sub>9</sub>H<sub>12</sub>ClN<sub>3</sub>O<sub>5</sub> 277.66

NC03341

10mg	\$50.00
25mg	\$100.00
50mg	\$160.00

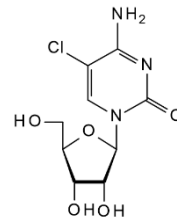

Refs: Fukuhara TK, Visser DW, J. Am. Chem. Soc. 1955, p2393; Badouard et.al, J. Chromatogr. 2005, 827, p26

C



**2-Chloro-3-deazaadenosine**

• 4-Amino-6-chloro-1-b-D-ribofuranosylimidazo[4,5-c]pyridine

[40656-71-1] C<sub>11</sub>H<sub>13</sub>ClN<sub>4</sub>O<sub>4</sub> 300.7

NC09808

1mg	\$75.00
2mg	\$130.00
5mg	\$250.00

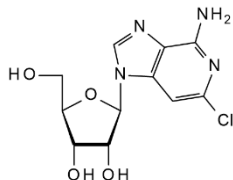
**6-Chloro-7-deaza-9-(5'-O-tert-butylidimethylsilyl-2',3'-O-isopropylidene-b-D-ribofuranosyl)purine**[115479-39-5] C<sub>20</sub>H<sub>30</sub>ClN<sub>5</sub>O<sub>4</sub>Si 440.02

NC06335

50mg	\$115.50
100mg	\$205.00
250mg	\$487.50

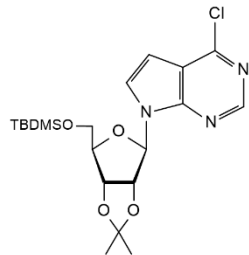
**6-Chloro-7-deazapurine-b-D-riboside**

see 6-Chloro-7-deaza-9-(b-D-ribofuranosyl)purine, NC05369 on page 141

**6-Chloro-7-deaza-9-(b-D-ribofuranosyl)purine**

• 6-Chloro-7-deazapurine-b-D-riboside

[16754-80-6] C<sub>11</sub>H<sub>12</sub>ClN<sub>5</sub>O<sub>4</sub> 285.69

NC05369

25mg	\$85.00
50mg	\$150.00
100mg	\$260.00

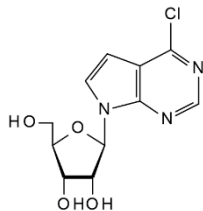
**6-Chloro-7-deaza-9-(2',3',5'-tri-O-acetyl-b-D-ribofuranosyl)purine**[16754-79-3] C<sub>17</sub>H<sub>18</sub>ClN<sub>5</sub>O<sub>7</sub> 411.79

NC06328

25mg	\$89.50
50mg	\$168.00
100mg	\$263.00

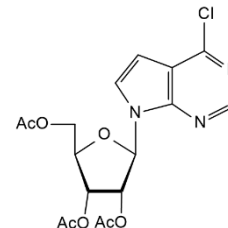
**2-Chloro-2'-deoxyadenosine 5'-triphosphate sodium salt**

• Cladribine triphosphate sodium salt

NC76589

Price On Application

**2-Chloro-2'-deoxyadenosine**

- Cladribine
- Leustatin
- 9-(2-Deoxy-b-D-ribofuranosyl)-2-chloroadenine

[4291-63-8] C<sub>10</sub>H<sub>12</sub>ClN<sub>5</sub>O<sub>3</sub> 285.69

NC06337

25mg	\$79.00
100mg	\$158.00
250mg	\$262.50

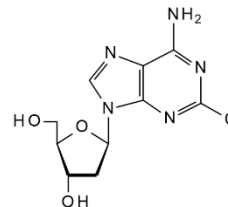

Refs: Kazimierczuk Z, Cottam HB, Revankar GR, et al. J. Am. Chem. Soc. 1984, 106, p6379; Set S, et al. J. Clin. Invest. 1985, 75, p377; Piro LD, et al. N. Engl. J. Med 1990, 322, p1117

**Chlorodeoxya****5'-Chloro-5'-deoxyadenosine**[892-48-8] C<sub>10</sub>H<sub>12</sub>ClN<sub>5</sub>O<sub>3</sub> 285.69

NC05644

5g	\$63.00
10g	\$105.00
25g	\$210.00

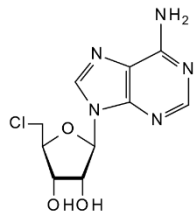
**8-Chloro-2'-deoxyadenosine**[85562-55-6] C<sub>10</sub>H<sub>12</sub>ClN<sub>5</sub>O<sub>3</sub> 285.69

NC03342

1mg	\$120.00
5mg	\$525.00
10mg	\$900.00

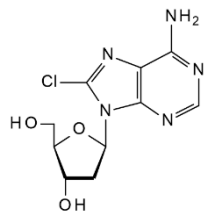
**1-(2'-Chloro-2'-deoxy-b-D-arabinofuranosyl)cytosine**[58461-30-6] C<sub>9</sub>H<sub>12</sub>ClN<sub>3</sub>O<sub>4</sub> 261.66

NC29834

Price On Application

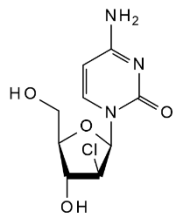
**2'-Chloro-2'-deoxycytidine**[10212-19-8] C<sub>9</sub>H<sub>12</sub>ClN<sub>3</sub>O<sub>4</sub> 261.66

NC03763

250mg	\$1500.00
500mg	\$2000.00
1g	\$3500.00

**5-Chloro-2'-deoxycytidine**[32387-56-7] C<sub>9</sub>H<sub>12</sub>ClN<sub>3</sub>O<sub>4</sub> 261.67

NC08279

5mg	\$120.00
10mg	\$190.00
25mg	\$375.00

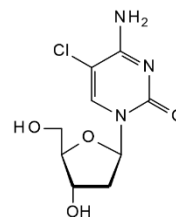

Refs: Hale et al, Biochem. Pharmacol, 2002, 64, p1493

**5-Chloro-5'-deoxycytidine**

• 5'-Deoxy-5-chloro-D-cytidine

C<sub>9</sub>H<sub>12</sub>ClN<sub>3</sub>O<sub>4</sub> 261.67

NC06308

50mg	\$100.00
100mg	\$189.00
250mg	\$420.00

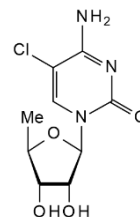

Refs: Cohen HM, Griffiths AD, Tawfik DS, et al, Org. Biomolec. Chem. 2005



**6-Chloro-9-(2'-deoxy-3',5'-di-O-toluoyl-b-ribofuranosyl)purine**[91713-46-1] C<sub>28</sub>H<sub>23</sub>ClN<sub>4</sub>O<sub>5</sub> 506.95

NC06411

50mg	\$89.50
100mg	\$158.00
250mg	\$262.50

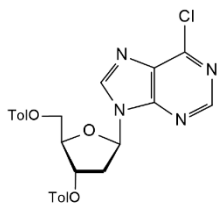
**6-Chloro-3'-deoxy-3'-fluorinosine**C<sub>10</sub>H<sub>10</sub>ClFN<sub>4</sub>O<sub>3</sub> 288.66

NC15615

Price On Application

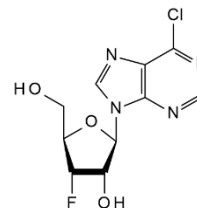
**6-Chloro-9-(2-deoxy-b-L-erythro-pentofuranosyl)-9H-purin-2-amine**[141771-78-0] C<sub>10</sub>H<sub>12</sub>ClN<sub>5</sub>O<sub>3</sub> 285.69

NC02987

Price On Application

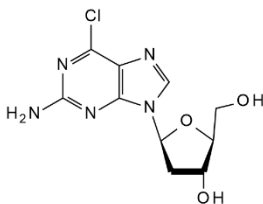
**8-Chloro-2'-deoxyguanosine**[437715-62-3] C<sub>10</sub>H<sub>12</sub>ClN<sub>5</sub>O<sub>4</sub> 301.69

NC06596

1mg	\$183.80
2mg	\$294.00
5mg	\$577.50

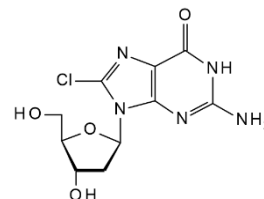

Refs: Masuda et.al, J. Biol. Chem, 2001, 276, p40486

**2-Chloro-2'-deoxy-2'-fluoroadenosine**

[156357-18-5]

NC76633

Price On Application

**6-Chloro-6-deoxyinosine**

see 6-Chloro-9-(b-D-ribofuranosyl)purine, NC06562 on page 153

**5-Chloro-5'-deoxy-5'-iodo-2',3'-O-isopropylidencytidine**C<sub>12</sub>H<sub>15</sub>ClIIN<sub>3</sub>O<sub>4</sub> 427.63

NC04650

50mg	\$94.50
100mg	\$168.00
250mg	\$315.00

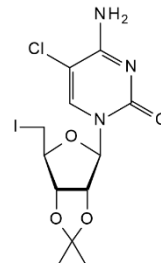

## Chlorodeoxyi

## 5-Chloro-5'-deoxy-5'-iodo-2',3'-O-isopropylideneuridine

[61787-10-8] C<sub>12</sub>H<sub>14</sub>ClIN<sub>2</sub>O<sub>5</sub> 428.61

NC02619

50mg	\$147.00
100mg	\$263.00
250mg	\$420.00

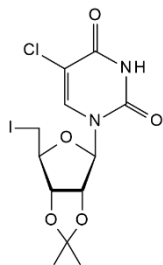

## 5-Chloro-5'-deoxy-5'-iodo-2',3'-O-(1-methylethylidene)uridine

see 5'-Deoxy-5'-iodo-2',3'-O-isopropylidene-5-chlorouridine, ND16525 on page 209

## 5-Chloro-5'-deoxy-2',3'-O-isopropylidencytidine

• 2',3'-O-Isopropylidene-5-chlorocytidine

C<sub>12</sub>H<sub>16</sub>ClN<sub>3</sub>O<sub>4</sub> 301.73

NC04653

50mg	\$105.00
100mg	\$189.00
250mg	\$382.50

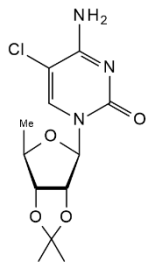

## 6-Chloro-7-[2-deoxy-3,5-bis-O-(4-methylbenzoyl)-b-D-erythro-pentofuranosyl]-7H-purine

see 3,5-Di-O-toluoyl 6-chloropurine-7-b-D-deoxyribose, ND16703 on page 254

## 2-Chloro-6-(2'-deoxy-b-D-ribofuranosyl)-3,5-diaminopyrazine

[173256-61-6] C<sub>9</sub>H<sub>13</sub>ClN<sub>4</sub>O<sub>3</sub> 260.68

NC06415

1mg	\$52.50
2mg	\$84.00
5mg	\$136.50

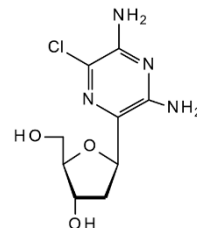

## 6-Chloro-9-(2'-deoxy-b-D-ribofuranosyl)purine

• 6-Chloropurine-2'-deoxyriboside

[4594-45-0] C<sub>10</sub>H<sub>11</sub>ClN<sub>4</sub>O<sub>3</sub> 270.68

NC06422

50mg	\$65.00
100mg	\$95.00
250mg	\$175.00

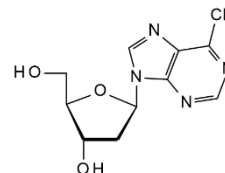

Refs: Maruenda H, Chenna A, Liem LK, Singer B, J. Org. Chem, 1998, 63, p4385

## 5-Chloro-1-(2-deoxy-b-D-threo-pentofuranosyl)-2,4(1H,3H)-pyrimidinedione

see 3'-epi-5-chloro-2'-deoxyuridine, NE16712 on page 268

## 3'-Chloro-3'-deoxy-5'-O-tritylthymidine

C<sub>29</sub>H<sub>27</sub>ClN<sub>2</sub>O<sub>4</sub> 503

NC07419

50mg	\$89.50
100mg	\$168.00
250mg	\$262.50

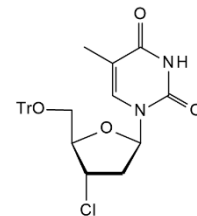

**2'-Chloro-2'-deoxyuridine**[4753-04-2] C<sub>9</sub>H<sub>11</sub>ClN<sub>2</sub>O<sub>5</sub> 262.65

NC04257

100mg	\$95.00
250mg	\$175.00
500mg	\$250.00

**5-Chloro-2'-deoxyuridine**[50-90-8] C<sub>9</sub>H<sub>11</sub>ClN<sub>2</sub>O<sub>5</sub> 262.65

NC04688

50mg	\$79.00
100mg	\$126.00
250mg	\$252.50

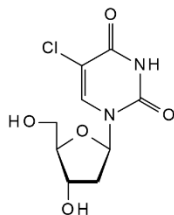

Refs: Young DW, Morris EM, Struct. Crystallogr. Cryst. Chem. 1973, B29, p1259

**5-Chloro-5'-deoxyuridine**

• 5'-Deoxy-5-chloro-D-uridine

C<sub>9</sub>H<sub>11</sub>ClN<sub>2</sub>O<sub>5</sub> 262.65

NC04680

50mg	\$131.50
100mg	\$205.00
250mg	\$420.00

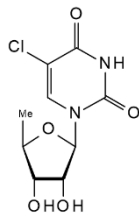

Refs: Vickers, Zhang MF, VisserJ, et al, Nucleosides Nucleotides and Nucleic Acids 2004, 23, p361

**6-Chloro-9-(3',5'-di-O-benzoyl-2'-Deoxy-2'-fluoro-b-D-arabinofuranosyl)purine**C<sub>24</sub>H<sub>18</sub>ClF<sub>2</sub>N<sub>4</sub>O<sub>5</sub> 496.89

NC08475

Price On Application

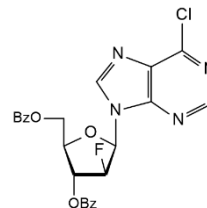
**5-Chloro-2',3'-dideoxy-3'-fluorouridine**[119644-22-3] C<sub>9</sub>H<sub>10</sub>ClF<sub>2</sub>N<sub>2</sub>O<sub>4</sub> 264.64

NC58336

50mg	\$600.00
100mg	\$1000.00
250mg	\$1750.00

**2-Chloro-5-(ethoxycarbonyl)-4-methylpyrimidine**see *Ethyl 2-chloro-4-methylpyrimidine-5-carboxylate, NE57420 on page 271***2-Chloro-5'-N-ethylcarboxamide-2',3'-O-isopropylidene adenosine**

- 1-(6-Amino-2-chloro-9H-purin-9-yl)-1-deoxy-N-ethyl-2,3-O-(1-methylethylidene)-b-D-ribofuranuronamide
- 2-Chloro-2',3'-O-isopropylideneadenosine-5'-N-ethylcarboxamide

[120225-75-4] C<sub>15</sub>H<sub>19</sub>ClN<sub>6</sub>O<sub>4</sub> 382.8

NC16518

5mg	\$140.00
10mg	\$225.00
25mg	\$495.00

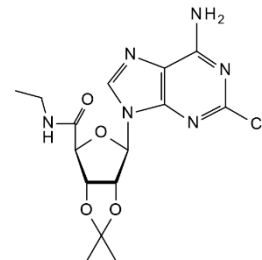

Refs: Hutchison, A.J, et al, J. Med. Chem. 33, 1919 (1990)



**ChloroFluoro****2-Chloro-4-[2-(4-Fluorophenyl)Ethyl]-6-Methylpyrimidine**[372183-70-5] C<sub>13</sub>H<sub>12</sub>ClFN<sub>2</sub> 250.7

NC57394

50mg	\$102.50
100mg	\$164.00
250mg	\$250.00

**4-Chloro-5-fluoropyrimidine**[347418-42-2] C<sub>4</sub>H<sub>2</sub>ClFN<sub>2</sub> 132.52

NC57386

500mg	\$65.00
1g	\$95.00
2g	\$180.00

**(S)-5-chloro-N2-(1-(5-fluoropyrimidin-2-yl)ethyl)-N4-(5-methyl-1H-pyrazol-3-yl)pyrimidine-2,4-diamine**

[935666-88-9]

NC44330

5mg	\$100.00
10mg	\$150.00
25mg	\$300.00

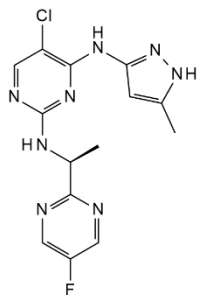
**6-Chloroguanine riboside**

see 2-Amino-6-chloro-9-(b-D-ribofuranosyl)purine, NA04201 on page 43

**6-Chloroguanosine**

see 2-Amino-6-chloro-9-(b-D-ribofuranosyl)purine, NA04201 on page 43

**8-Chloroguanosine**[2104-68-9] C<sub>10</sub>H<sub>12</sub>ClN<sub>5</sub>O<sub>5</sub> 317.69

NC06679

2mg	\$189.00
5mg	\$367.50
10mg	\$630.00

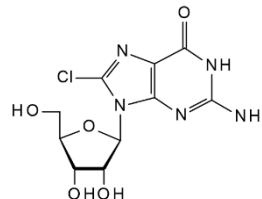

Refs: Gerster JF Hinshaw BC, Robins RK, et al, J. Org. Chem. 1968, p1070

**2-Chloro-4-hydroxy-5-fluoropyrimidine**[155-12-4] C<sub>4</sub>H<sub>2</sub>ClFN<sub>2</sub>O 148.52

NC11515

10g	\$525.00
25g	\$1050.00
50g	\$1575.00

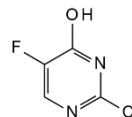
**6-Chloro-2-hydroxy-9-(2',3',5'-tri-O-acetyl-b-D-ribofuranosyl)purine**[161923-50-8] C<sub>18</sub>H<sub>17</sub>ClN<sub>4</sub>O<sub>8</sub> 428.78

NC04527

10mg	\$115.50
25mg	\$210.00
50mg	\$367.50

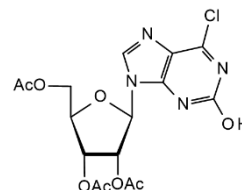
**Chloro-IB-MECA**

see 2-Chloro-N6-(3-iodobenzyl)-adenosine-5'-N-methyluronamide, NC30706 on page 147

**4-Chloro-6-imidazol-1-yl-pyrimidine**

[114834-02-5] 180.59

NC57449

500mg	\$65.00
1g	\$148.70
2g	\$237.90

**2-Chloroinosine**[13276-43-2] C<sub>10</sub>H<sub>11</sub>ClN<sub>4</sub>O<sub>5</sub> 302.67

NC03338

50mg	\$60.00
100mg	\$90.00
250mg	\$150.00

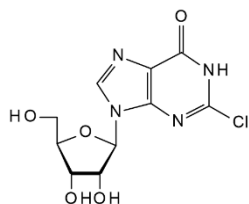

Refs: Gerster JF, Robins RK, J. Org. Chem. 1966, Vol31, p3258

**8-Chloroinosine**[116285-77-9] C<sub>10</sub>H<sub>11</sub>ClN<sub>4</sub>O<sub>5</sub> 302.67

NC03330

1mg	\$157.50
5mg	\$420.00
10mg	\$724.50

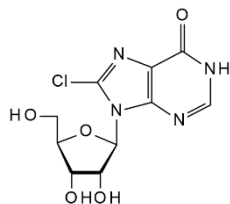

Refs: Langeveld CH, Jongenelen CAM, Heimans JJ, et al, Cancer Res. 1992, Vol52, Issue 14, p3994-3999

**2-Chloro-N6-(3-iodobenzyl)-adenosine-5'-N-methyluronamide**

• Chloro-IB-MECA

[163042-96-4] C<sub>18</sub>H<sub>18</sub>ClIN<sub>6</sub>O<sub>4</sub> 544.73

NC30706

10mg	\$50.00
25mg	\$80.00
50mg	\$120.00

**4-7H-Chloro-5-iodo-7-(2-C-methyl-b-D-ribofuranosyl)-7H-pyrrolo[2,3-d]pyrimidin-2-amine**

[847551-58-0]

NC14083

Price On Application

**5-Chloro-2-iodopyrimidine**

[874676-81-0]

NC70377

1g	\$50.00
2g	\$80.00
5g	\$125.00

**4-Chloro-5-iodo-pyrrolo[2,3-d]pyrimidine-7-carboxylic acid tert-butyl ester**

[1244855-76-2]

NC44293

250mg	\$97.50
500mg	\$155.00
1g	\$247.50

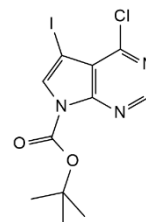
**6-Chloro-2-iodo-9-b-D-ribofuranosyl-9H-purine triacetate**

see 6-Chloro-2-iodo-9-(2',3',5'-tri-O-acetyl-b-D-ribofuranosyl)purine, NC16519 on page 148

**Chloriodotr****6-Chloro-2-iodo-9-(2',3',5'-tri-O-acetyl-b-D-ribofuranosyl)purine**C<sub>16</sub>H<sub>16</sub>ClI<sub>2</sub>N<sub>4</sub>O<sub>7</sub> 538.68

NC07420

50mg	\$89.50
100mg	\$168.00
250mg	\$262.50

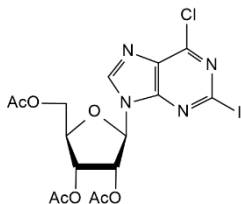
**6-Chloro-2-iodo-9-(2',3',5'-tri-O-acetyl-b-D-ribofuranosyl)purine**

• 6-Chloro-2-iodo-9-b-D-ribofuranosyl-9H-purine triacetate

[5987-76-8] C<sub>16</sub>H<sub>16</sub>ClI<sub>2</sub>N<sub>4</sub>O<sub>7</sub> 538.68

NC16519

50mg	\$140.00
100mg	\$255.00
250mg	\$462.50

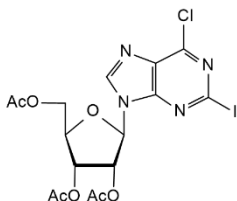
**2-Chloroisonicotinic acid**

see 2-Chloro-4-pyridinecarboxylic acid, NC70186 on page 152

**2-Chloroisonicotinic acid**

• 2-Chloro-4-pyridinecarboxylic acid

[6313-54-8] C<sub>6</sub>H<sub>4</sub>ClNO<sub>2</sub> 157.55

NC70185

100g	\$60.00
250g	\$100.00
500g	\$180.00

**2-Chloro-2',3'-O-isopropylideneadenosine-5'-N-ethylcarboxamide**

see 2-Chloro-5'-N-ethylcarboxamide-2',3'-O-isopropylidene adenosine, NC16518 on page 145

**2-Chloro-2',3'-O-isopropylideneadenosine**

• 2-Chloroadenosine-2',3'-acetone

[24639-06-3] C<sub>13</sub>H<sub>16</sub>ClN<sub>5</sub>O<sub>4</sub> 341.76

NC06329

50mg	\$132.00
100mg	\$195.00
250mg	\$375.00

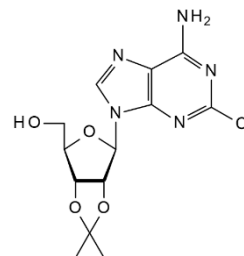
**5-Chloro-2',3'-O-isopropylidene cytidine**C<sub>12</sub>H<sub>16</sub>ClN<sub>3</sub>O<sub>5</sub> 317.73

NC04761

50mg	\$89.50
100mg	\$168.00
250mg	\$250.00

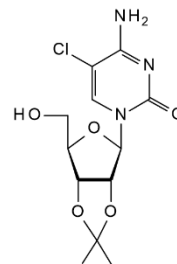
**6-Chloro-9-(2',3'-O-isopropylidene-b-D-ribofuranosyl)purine**

• 6-Chloropurine-9-(2,3-isopropylidene-b-D-ribofuranoside)

[39824-26-5] C<sub>13</sub>H<sub>15</sub>ClN<sub>4</sub>O<sub>4</sub> 326.74

NC04682

250mg	\$62.50
500mg	\$110.00
1g	\$210.00

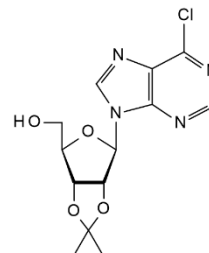



**5-Chloro-1-(2,3-O-isopropylidene-b-D-ribofuranosyl)uracil**

see 5-Chloro-2',3'-O-isopropylideneuridine, NC04756 on page 149

**5-Chloro-2',3'-O-isopropylideneuridine**

• 5-Chloro-1-(2,3-O-isopropylidene-b-D-ribofuranosyl)uracil

[81356-82-3] C<sub>12</sub>H<sub>15</sub>ClN<sub>2</sub>O<sub>6</sub> 318.72

NC04756

50mg	\$89.50
100mg	\$158.00
250mg	\$262.50

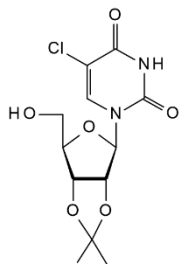
**2-Chloro-6-methoxypurine riboside**

see 2-Chloro-6-O-methylinosine, NC16520 on page 149

**2-Chloro-6-methoxy-9-b-D-ribofuranosyl-9H-purine**

see 2-Chloro-6-O-methylinosine, NC16520 on page 149

**4'-Chloromethyl-2'-deoxy-3',5'-di-O-isobutyryl-2'-fluorocytidine**

see ALS-8176, NA63420 on page 33

**2-Chloro-6-O-methylinosine**

- 2-Chloro-6-methoxy-9-b-D-ribofuranosyl-9H-purine
- 2-Chloro-6-methoxypurine riboside
- NSC 31144

[15465-92-6] C<sub>11</sub>H<sub>13</sub>ClN<sub>4</sub>O<sub>5</sub> 316.7

NC16520

100mg	\$140.00
250mg	\$255.00
500mg	\$465.00

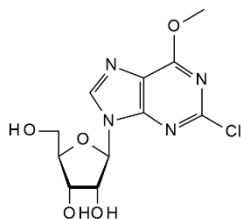

Refs: Long, M, et al, Biochem. Pharmacol, 71, 1671 (2006)

**4-Chloro-5-methyl-7-(2-C-methyl-b-D-ribofuranosyl)-7H-pyrrolo[2,3-d]pyrimidine**

[443642-55-5]

NC14090

Price On Application

**6-Chloro-9-methylpurine**[2346-74-9] C<sub>6</sub>H<sub>5</sub>ClN<sub>4</sub> 168.58

NC11301

50mg	\$115.00
100mg	\$150.00
250mg	\$325.00

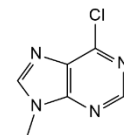
**2-Chloro-6-methyl-pyrimidine-4-carboxylic acid methyl ester**

see Methyl 2-chloro-6-methylpyrimidine-4-carboxylate, NM57398 on page 313

**6-Chloro-N4-methyl-4,5-pyrimidinediamine**

[52602-68-3]

NC44314

Price On Application

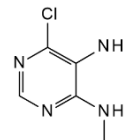
**4-Chloro-6-methyl-7H-pyrrolo[2,3-d]pyrimidine**

[35808-68-5]

NC44312

Price On Application

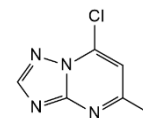

## Chloromethyl

## 6-Chloro-9-(2-C-methyl-beta-D-ribofuranosyl)-9H-purine

[205171-05-7] C<sub>11</sub>H<sub>13</sub>ClN<sub>4</sub>O<sub>4</sub> 300.7

NC14079

2g	\$1250.00
5g	\$2475.00
10g	\$3705.00



## 5-Chloro-7-(2-C-methyl-b-D-ribofuranosyl)-7H-pyrrolo[2,3-d]pyrimidin-4-amine

[443642-46-4] C<sub>12</sub>H<sub>15</sub>ClN<sub>4</sub>O<sub>4</sub> 314.72

NC14096

Price On Application



## 4-Chloro-7-(2-C-methyl-b-D-ribofuranosyl)-7H-pyrrolo[2,3-d]pyrimidine

[443642-33-9] C<sub>12</sub>H<sub>14</sub>ClN<sub>4</sub>O<sub>4</sub> 299.71

NC14084

Price On Application

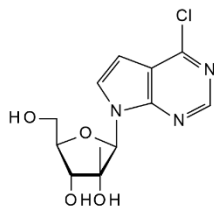

## 7-Chloro-3-methyl-3H-1,2,3-triazolo[4,5-d]pyrimidine

[21323-71-7]

NC44308

Price On Application

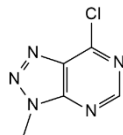

## 7-Chloro-5-methyl-[1,2,4]triazolo[1,5-a]pyrimidine

[24415-66-5]

NC44309

Price On Application

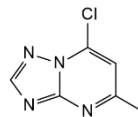

## 2-[2-(4-Chlorophenyl)ethoxy]adenosine

- Sonedenoson
- MRE 0094

[131865-88-8] C<sub>18</sub>H<sub>20</sub>ClN<sub>5</sub>O<sub>5</sub> 421.83

NC16521

10mg	\$65.00
25mg	\$100.00
50mg	\$150.00

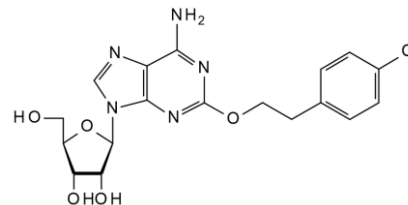

Refs: Gao, Z. et al, Biochem. Pharmacol, 68, 1985 (2004)



## 4-(4-Chlorophenyl)pyrimidin-2-amine

see 2-Amino-4-(4-chlorophenyl)pyrimidine, NA57403 on page 42

## 4-(4-Chlorophenyl)pyrimidine-2-thiol

[175203-08-4]

NC44282

1g	\$87.90
2g	\$140.70
5g	\$225.00

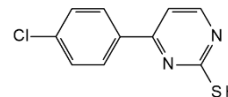

**8-(4-Chlorophenylthio)adenosine 3',5'-cyclic monophosphate**

• pCPT-cAMP

[93882-12-3] C<sub>16</sub>H<sub>15</sub>ClN<sub>5</sub>O<sub>6</sub>PS 471.81

NC10429

25mg	\$121.00
50mg	\$205.00
100mg	\$315.00

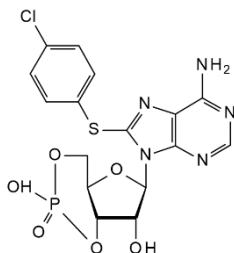
**8-(4-Chlorophenylthio)guanosine 3',5'-cyclic monophosphate sodium salt**

• 8-pCPT-cGMP

[51239-26-0] C<sub>16</sub>H<sub>14</sub>ClN<sub>5</sub>O<sub>7</sub>PS·Na 509.79

NC10430

5mg	\$78.80
10mg	\$115.50
25mg	\$171.00

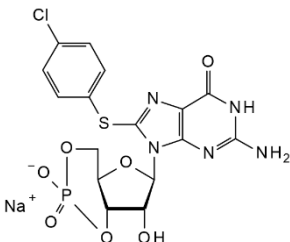
**8-(4-Chlorophenylthio)guanosine 3',5'-cyclic monophosphothioate Sp-isomer sodium salt**[160385-87-5] C<sub>16</sub>H<sub>14</sub>ClN<sub>5</sub>O<sub>6</sub>PS<sub>2</sub>·Na 525.86

NC10428

1mg	\$125.00
2mg	\$210.00
5mg	\$475.00

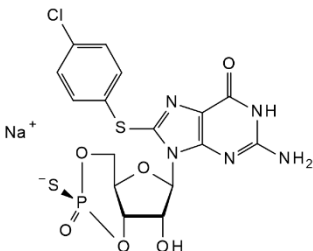

Refs: Protected by patent DE4217679 and foreign equivalents, exclusively licensed or issued to BIOLOG LSI,

**8-(4-Chlorophenylthio)-2'-O-methyladenosine 3',5'-cyclic monophosphate sodium salt**

• 8CPT-2Me-cAMP sodium salt

[510774-50-2][634207-53-7] C<sub>17</sub>H<sub>16</sub>ClN<sub>5</sub>O<sub>6</sub>PS·Na 507.82

NC10431

1mg	\$175.00
2mg	\$250.00
5mg	\$525.00

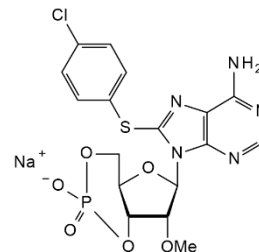

Refs: Protected by patent no. EP 02077219.0 and foreign equivalents, exclusively licensed to BIOLOG LSI for research purposes only,

**4-[(1Z)-2-(4-Chlorophenyl)vinyl]pyridine**

[2502-99-0][45459-15-8]

NC65881

10mg	\$50.00
25mg	\$100.00
50mg	\$180.00

**5-Chloropicolinic acid methyl ester**

see 5-Chloro-2-pyridinecarboxylic acid methyl ester, NC66914 on page 152

**6-Chloropurine-2'-deoxyriboside**

see 6-Chloro-9-(2'-deoxy-b-D-ribofuranosyl)purine, NC06422 on page 144

**6-Chloropurine-9-b-D-glucoside**[66981-23-5] C<sub>11</sub>H<sub>13</sub>ClN<sub>4</sub>O<sub>5</sub> 420.16

NC29022

Price On Application



**Chloropurine****6-Chloropurine-9-(2,3-isopropylidene-b-D-ribofuranoside)**

see 6-Chloro-9-(2',3'-O-isopropylidene-b-D-ribofuranosyl)purine, NC04682 on page 148

**6-Chloropurine-9-(5-methyl-beta-D-ribofuranoside)**

see 6-(5'-Methyl-b-D-ribofuranosyl)-6-chloropurine, NM144826 on page 323

**6-Chloropurine riboside 5'-monophosphate disodium salt**[5843-59-4] C<sub>10</sub>H<sub>10</sub>ClN<sub>4</sub>Na<sub>2</sub>O<sub>7</sub>PH<sub>2</sub>O 428.63

NC29021	25mg	\$2300.00
	50mg	\$2725.00
	100mg	\$3200.00

**6-Chloropurine riboside**

see 6-Chloro-9-(b-D-ribofuranosyl)purine, NC06562 on page 153

**2-Chloropurine**[1681-15-8] C<sub>5</sub>H<sub>3</sub>ClN<sub>4</sub> 154.56

NC15936	100mg	\$75.00
	250mg	\$125.00
	500mg	\$200.00

**5-Chloro-2-pyridinecarboxylic acid methyl ester**

• 5-Chloropicolinic acid methyl ester

[132308-19-1] C<sub>7</sub>H<sub>6</sub>ClNO<sub>2</sub> 171.58

NC66914	1g	\$90.00
	2g	\$144.00
	5g	\$265.00

**2-Chloro-4-pyridinecarboxylic acid**

• 2-Chloroisonicotinic acid

[6313-54-8] C<sub>6</sub>H<sub>4</sub>ClNO<sub>2</sub> 157.55

NC70186

Price On Application

**2-Chloro-4-pyridinecarboxylic acid**

see 2-Chloroisonicotinic acid, NC70185 on page 148

**4-Chloropyrimidin-5-amine**

see 4-Chloro-5-aminopyrimidine, NC57423 on page 140

**2-Chloro-4-pyrimidinecarbonitrile**

• 2-Chloro-4-cyanopyrimidine

[75833-38-4] C<sub>5</sub>H<sub>2</sub>ClN<sub>3</sub> 139.54

NC57397	250mg	\$70.00
	500mg	\$110.00
	1g	\$292.00

**2-Chloropyrimidine-4-carboxamide**[22536-66-9] C<sub>5</sub>H<sub>4</sub>ClN<sub>2</sub>O 157.56

NC57418	100mg	\$82.00
	250mg	\$97.50
	500mg	\$155.00



**6-Chloro-9-(b-D-ribofuranosyl)purine**

- 6-Chloropurine riboside
- 6-Chloro-6-deoxyinosine
- 6-Chloro-9-(beta-D-ribofuranosyl)purine

[5399-87-1][2004-06-0] C<sub>10</sub>H<sub>11</sub>ClN<sub>4</sub>O<sub>4</sub> 286.68

NC06562

25g	\$75.00
50g	\$125.00
100g	\$195.00

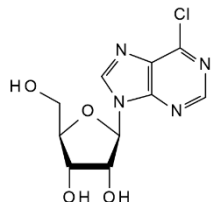

Refs: Hocek M, Holy A, Collect. Czech. Chem. Commun. Abs. 1995, 60, p1386; Mol. Pharmacol. 1966, 2, p574

**6-Chloro-9-(beta-D-ribofuranosyl)purine**

see 6-Chloro-9-(b-D-ribofuranosyl)purine, NC06562 on page 153

**6-Chloro-9-(2',3',5'-tri-O-acetyl-b-D-ribofuranosyl)purine**C<sub>16</sub>H<sub>17</sub>ClN<sub>4</sub>O<sub>7</sub> 412.79

NC07342

1g	\$89.30
2g	\$168.00
5g	\$262.50

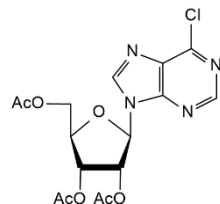
**5-Chlorouridine**[2880-89-9] C<sub>9</sub>H<sub>11</sub>ClN<sub>2</sub>O<sub>6</sub> 278.65

NC02866

500mg	\$95.00
1g	\$157.50
2g	\$283.50

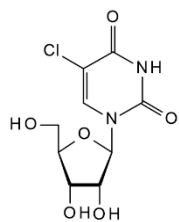

Refs: Fukuhara TKAY, Visser DW, J. Biological Chem. Vol190, No1, p95-101

**N1-cIDPR**

see Cyclic inosine diphosphate ribose, NC63575 on page 157

**Citicoline sodium salt**

- Cytidine 5'-diphosphocholine sodium salt
- CDP-choline sodium salt

[33818-15-4] C<sub>14</sub>H<sub>26</sub>N<sub>4</sub>O<sub>11</sub>P<sub>2</sub>Na 511.31

NC05679

25g	\$50.00
50g	\$90.00
100g	\$125.00

**Cladribine triphosphate sodium salt**

see 2-Chloro-2'-deoxyadenosine 5'-triphosphate sodium salt, NC76589 on page 141

**Cladribine**

see 2-Chloro-2'-deoxyadenosine, NC06337 on page 141

**8-Cl-5'-AMP**

see 8-Chloroadenosine-5'-monophosphate, NC71639 on page 139

**8-Cl-cAMP**

see 8-Chloroadenosine 3',5'-cyclic monophosphate, NC10380 on page 139

**Clevudine**

- Levovir
- 2'-Deoxy-2'-fluoro-5-methylarabinofuranosyluracil
- 1-(2'-Deoxy-2'-fluoro-b-L-arabinofuranosyl)-5-methyluracil

[163252-36-6] C<sub>10</sub>H<sub>13</sub>FN<sub>2</sub>O<sub>5</sub> 260.22

NC09470

50mg	\$55.00
100mg	\$85.00
250mg	\$170.00

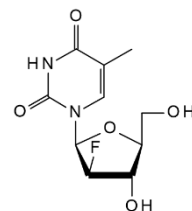

**Clevudine****Clevudine-d4**C<sub>10</sub>H<sub>9</sub>FN<sub>2</sub>O<sub>5</sub>D<sub>4</sub> 264.25

NC09471

Price On Application

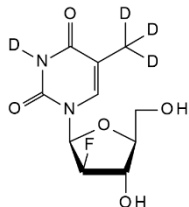
**Clofarabine 5'-monophosphate triethylammonium salt**

NC15334

1mg	\$504.00
2mg	\$882.00
5mg	\$1890.00

**Clofarabine 5'-triphosphate triethylammonium salt**C<sub>10</sub>H<sub>14</sub>ClFN<sub>5</sub>O<sub>12</sub>P<sub>3</sub> 543.62 (free acid)

NC15333

1mg	\$395.00
2mg	\$700.00
5mg	\$1460.00

**Clofarabine**

see 6-Amino-2-chloro-9-(2'-deoxy-2'-fluoro-b-D-arabinofuranosyl)purine, NA07154 on page 40

**2'-CMethylcytidine 5'-monophosphate**

NM29278

Price On Application

**5'-CMP.2Na**

see Cytidine 5'-monophosphate disodium salt, NC05637 on page 160

**2'-CMP**

see Cytidine 2'-monophosphate sodium salt, NC13474 on page 161

**Coaristeromycin**

see Carbocyclic inosine, NC29205 on page 136

**CoA triiithium salt**

see Coenzyme A triiithium salt, NC20534 on page 155

**CoA**

see Coenzyme A hydrate, NC45965 on page 154

**Coenzyme A hydrate**

• CoA

[85-61-0]	C <sub>21</sub> H <sub>36</sub> N <sub>7</sub> O <sub>16</sub> P <sub>3</sub> S·xH <sub>2</sub> O	767.54 (anhydrous basis)		
			25mg	\$60.00
NC45965			50mg	\$95.00
			100mg	\$175.00

**Coenzyme A sodium salt hydrate**[55672-92-9] C<sub>21</sub>H<sub>36</sub>N<sub>7</sub>O<sub>16</sub>P<sub>3</sub>SNa 790.53

			10mg	\$65.00
NC47123			25mg	\$105.00
			50mg	\$195.00



**Coenzyme A trilithium salt**

- CoA trilithium salt
- Trilithium coenzyme A

[18439-24-2] C<sub>21</sub>H<sub>33</sub>Li<sub>3</sub>N<sub>7</sub>O<sub>16</sub>P<sub>3</sub>S 785.33

NC20534	25mg	\$60.00
	50mg	\$95.00
	100mg	\$175.00



Refs: Strickland K.C. et al, J. Biol. Chem, 285, 1627 (2010); Elovson J. et al, J. Biol. Chem, 243, 3603 (1968)

**coenzyme II**see *b-Nicotinamide adenine dinucleotide phosphate potassium salt hydrate, NN11481 on page 331***Coenzyme 1**see *b-Nicotinamide adenine dinucleotide, NN11969 on page 333***Coenzyme 1**see *b-Nicotinamide adenine dinucleotide sodium salt dihydrate, NN44827 on page 333***Cordycepin**see *3'-Deoxyadenosine, ND02930 on page 173***9-Cordyceposidoadenine**see *3'-Deoxyadenosine, ND02930 on page 173***Coviracil**

- Emtricitabine
- (-)-2',3'-Dideoxy-5-fluoro-3'-thiacytidine
- (-)-cis-FTC

[143491-57-0][143491-54-7] C<sub>8</sub>H<sub>10</sub>FN<sub>3</sub>O<sub>3</sub>S 247.25

NC05645	1g	\$55.00
	2g	\$90.00
	5g	\$175.00

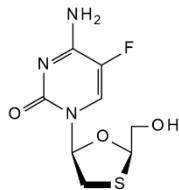
**CPA**see *N(6)-Cyclopentyladenosine, NC45738 on page 158***6-cPe-5'-AMP**see *N6-Cyclopentyladenosine-5'-O-monophosphate, NN64048 on page 158***8CPT-2Me-cAMP sodium salt**see *8-(4-Chlorophenylthio)-2'-O-methyladenosine 3',5'-cyclic monophosphate sodium salt, NC10431 on page 151***CP-4126**see *Gemcitabine 5'-elaidate, NC05399 on page 281***Crotonoside**see *Isoguanosine hydrate, NI07234 on page 298***2,2-Cryo-5-methyluridine**

NC04077

Price On Application

**5'-CTP-Na2**see *Cytidine 5'-triphosphate disodium salt dihydrate, NC66105 on page 161***5'-CTP-2Na**see *Cytidine 5'-triphosphate disodium salt, NC03860 on page 161***1'-13C<sub>U</sub>ridine**[201996-62-5] <sup>13</sup>C<sub>8</sub>H<sub>12</sub>N<sub>2</sub>O<sub>6</sub> 245.19

NU34299	10mg	\$136.50
	25mg	\$304.50
	50mg	\$525.00

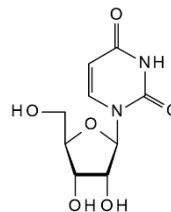

**CUridine****2'-13C Uridine**

[478511-11-4] <sup>13</sup>CC<sub>8</sub>H<sub>12</sub>N<sub>2</sub>O<sub>6</sub> 245.19  
 100mg \$910.00  
 NU34300

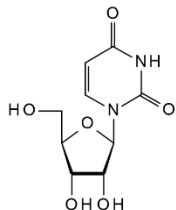
**2'-Cyano-2'-deoxy-1-(β-D-arabinofuranosyl)cytosine**

[135598-68-4] C<sub>10</sub>H<sub>12</sub>N<sub>4</sub>O<sub>4</sub> 252.23  
 Price On Application  
 NC29827

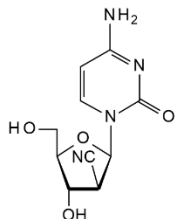
**6-O-(2-Cyanoethyl)-2'-deoxy-5'-O-DMT-N2-Isobutyrylguanosine**

[90662-86-5] C<sub>38</sub>H<sub>40</sub>N<sub>6</sub>O<sub>7</sub> 692.76  
 Price On Application  
 NC141773

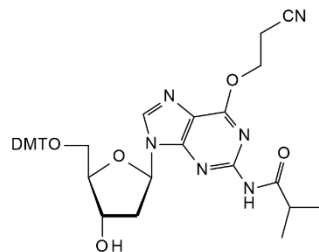
**Cyclic adenosine 5'-diphosphate ribose ammonium salt**

• ADP-cyclo[N1:1']-ribose  
 [119340-53-3] C<sub>15</sub>H<sub>21</sub>N<sub>5</sub>O<sub>13</sub>P<sub>2</sub>·NH<sub>3</sub> 558.33  
 250ug \$225.00  
 500ug \$350.00  
 1mg \$675.00  
 NC11582

**Cyclic AMP**

see *Adenosine 3',5'-cyclic monophosphate, NA08991 on page 22*

**Cyclic bis (3',5') diguanylic acid**

see *Cyclic diguanosine monophosphate, NC46014 on page 157*

**Cyclic di-adenosine monophosphate sodium salt**

• Cyclic diadenylate  
 • Cyclic di-AMP  
 [54447-84-6] C<sub>20</sub>H<sub>24</sub>N<sub>10</sub>O<sub>12</sub>P<sub>2</sub>·xNa 658.41 (free acid basis)  
 1mg \$320.00  
 2mg \$550.00  
 5mg \$1200.00  
 NC64061

**Cyclic diadenylate**

see *Cyclic di-adenosine monophosphate sodium salt, NC64061 on page 156*

**Cyclic di-AMP**

see *Cyclic di-adenosine monophosphate sodium salt, NC64061 on page 156*

**Cyclic-di-GMP**

see *Cyclic diguanosine monophosphate, NC46014 on page 157*



**Cyclic diguanosine monophosphate 2'-PEG**

NC59484

Price On Application

**Cyclic diguanosine monophosphate**

- C-di-GMP
- Cyclic-di-GMP
- Cyclic bis (3',5') diguanylic acid

[61093-23-0] C<sub>20</sub>H<sub>24</sub>N<sub>10</sub>O<sub>14</sub>P<sub>2</sub> 690.41

NC46014

1mg	\$320.00
2mg	\$550.00
5mg	\$1200.00

**3',3'-Cyclic GAMP**

- Cyclic [G(3',5')pA(3',5')p]

- cyclic GMP-AMP
- c-GpAp sodium salt

[849214-04-6] C<sub>20</sub>H<sub>22</sub>N<sub>10</sub>O<sub>13</sub>P<sub>2</sub>·2Na 718.38

NC137624

Price On Application

**cyclic GMP-AMP**

see 3',3'-Cyclic GAMP, NC137624 on page 157

**cyclic GMP**

see Guanosine 3',5'-cyclic monophosphate sodium salt, NG08975 on page 283

**Cyclic [G(3',5')pA(3',5')p]**

see 3',3'-Cyclic GAMP, NC137624 on page 157

**Cyclic inosine diphosphate ribose**

- N1-clDPR

[856702-89-1] C<sub>15</sub>H<sub>20</sub>N<sub>4</sub>O<sub>14</sub>P<sub>2</sub> 542.29

NC63575

Price On Application

**8,5'-(S)-Cycloadenosine**[41432-67-1] C<sub>10</sub>H<sub>11</sub>N<sub>5</sub>O<sub>4</sub> 265.23

NC01366

5mg	\$215.30
10mg	\$325.50
25mg	\$709.00

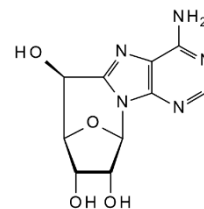
**Cyclocytidine HCl**

see 2,2'-Anhydrocytidine HCl, NA01967 on page 67

**2-(2-Cyclohexylethoxy)adenosine**

- WRC 0013

[131933-18-1] C<sub>18</sub>H<sub>27</sub>N<sub>5</sub>O<sub>5</sub> 393.44

NC16523

50mg	\$140.00
100mg	\$255.00
250mg	\$462.50

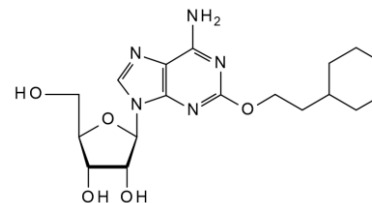

Refs: Gao, Z, et al, Biochem. Pharmacol, 68, 1985 (2004); Perez G, et al, Bioorg. Med. Chem, 12, 2985 (2004); Adachi, H, et al, J. Med. Chem, 50, 1810 (2007)

**Cyclohexylpy****2-Cyclohexyl-5-pyrimidinecarbaldehyde**[959240-13-2] C<sub>11</sub>H<sub>14</sub>N<sub>2</sub>O 190.24

NC57440

1g	\$81.40
2g	\$130.10
5g	\$323.00

**Cyclopentenylyl cytosine 5'-triphosphate sodium salt**

NC58674

Price On Application

**Cyclopentenylyl cytosine**

• 4-Amino-1-[[1R,4R,5S)-4,5-dihydroxy-3-(hydroxymethyl)-2-cyclopenten-1-yl]-2(1H)-pyrimidinone

[90597-22-1] C<sub>10</sub>H<sub>13</sub>N<sub>3</sub>O<sub>4</sub> 239.23

NC58281

1mg	\$650.00
2mg	\$1200.00
5mg	\$2500.00

**N6-Cyclopentyladenosine-5'-O-monophosphate**

• 6-cPe-5'-AMP

[117778-38-8] C<sub>15</sub>H<sub>22</sub>N<sub>5</sub>O<sub>7</sub>P 415.34

NN64048

Price On Application

**N(6)-Cyclopentyladenosine**

• CPA

[41552-82-3] C<sub>15</sub>H<sub>21</sub>N<sub>5</sub>O<sub>4</sub> 335.36

NC45738

10mg	\$55.00
25mg	\$90.00
50mg	\$140.00

**N6-Cyclopentyl-2'-C-methyl-adenosine**[205171-06-8] C<sub>16</sub>H<sub>23</sub>N<sub>5</sub>O<sub>4</sub> 349.39

NC14080

25mg	\$57.50
50mg	\$90.00
100mg	\$145.00

**4-(Cyclopropylamino)-2-(Methylthio)Pyrimidine-5-Carboxylic Acid**[1015856-32-2] C<sub>9</sub>H<sub>11</sub>N<sub>3</sub>O<sub>2</sub>S 225.27

NC57384

25mg	\$93.00
50mg	\$186.00
100mg	\$298.00

**5'-(N-Cyclopropyl)carboxamidoadenosine**[50908-62-8] C<sub>13</sub>H<sub>16</sub>N<sub>6</sub>O<sub>4</sub> 320.31

NC07982

5mg	\$125.00
10mg	\$200.00
25mg	\$375.00

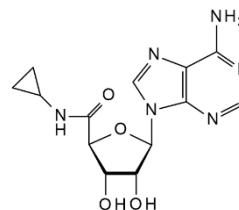
**O-2,2'-Cyclouridine**

see 2,2'-Anhydrouridine, NA05939 on page 69

**Cytarabine HCl**see 1-(*b*-D-Arabinofuranosyl)cytosine HCl, NA05780 on page 73**Cytarabine-5-monophosphate-15N2,13C1**

NC11680

Price On Application

**Cytarabine 5'-Monophosphate**see 1-(*b*-D-Arabinofuranosyl)cytosine 5'-monophosphate, NA10080 on page 73**Cytarabine 5'-triphosphate triethylammonium salt**see 1-(*b*-D-Arabinofuranosyl)cytosine 5'-triphosphate triethylammonium salt, NA15329 on page 73**Cytarabine-5-b,Y-(1-hydroxyethylidene) triphosphate-d3**

NC11678

Price On Application

**Cytarabine**see 1-(*b*-D-Arabinofuranosyl)cytosine, NA05771 on page 73**Cytidine 5'-[3-(2-aminoethyl) dihydrogen diphosphate] disodium salt**

see Cytidine 5'-diphosphate ethanolamine disodium salt, NC28916 on page 160

**Cytidine based prodrug with gemcitabine**

NC04468

Price On Application

**Cytidine-5-carboxylic acid sodium salt**

[64623-37-6]

NC15472

5mg	\$160.00
10mg	\$290.00
25mg	\$575.00

**Cytidine 2',3'-cyclic monophosphate monosodium salt**[15718-51-1] C<sub>9</sub>H<sub>11</sub>N<sub>3</sub>O<sub>7</sub>P·Na 327.16

NC11429

10mg	\$75.00
25mg	\$135.00
50mg	\$175.00

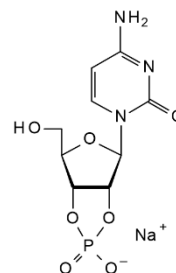
**Cytidine 3',5'-cyclic monophosphate monosodium salt**[54925-33-6] C<sub>9</sub>H<sub>11</sub>N<sub>3</sub>O<sub>7</sub>PNa 327.16

NC09356

10mg	\$199.50
25mg	\$394.00
50mg	\$630.00

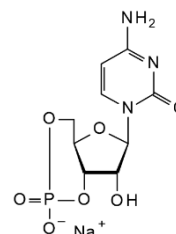

**Cytidinediph****Cytidine 5'-diphosphate disodium salt**[54394-90-0] C<sub>9</sub>H<sub>13</sub>N<sub>3</sub>O<sub>11</sub>P<sub>2</sub>·Na<sub>2</sub> 447.14

NC09380

2g	\$60.00
5g	\$100.00
10g	\$160.00

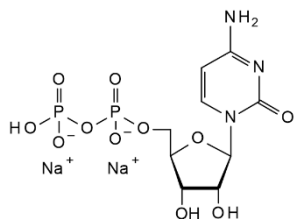
**Cytidine 5'-diphosphate ethanolamine disodium salt**

- Cytidine 5'-[3-(2-aminoethyl) dihydrogen diphosphate] disodium salt
- CDP-ethanolamine disodium salt

[3036-18-8] C<sub>11</sub>H<sub>18</sub>N<sub>4</sub>O<sub>11</sub>P<sub>2</sub> 490.21

NC28916

1mg	\$95.00
2mg	\$150.00
5mg	\$300.00

**Cytidine-5'-diphosphate trisodium salt**

- CYTIDINE-5'-DIPHOSPHATE trisodium salt

[34393-59-4] C<sub>9</sub>H<sub>12</sub>N<sub>3</sub>Na<sub>3</sub>O<sub>11</sub>P<sub>2</sub> 469.12

NC46163

50mg	\$50.00
100mg	\$85.00
250mg	\$140.00

**Cytidine 5'-diphosphocholine sodium salt**see *Citicoline sodium salt*, NC05679 on page 153**Cytidine hemisulfate salt**

- Cytosine b-D-ribose hemisulfate salt

[6018-48-0] 292.26

NC57355

Price On Application

**Cytidine 5'-monophosphate disodium salt**

- 5'-CMP.2Na

[6757-06-8] C<sub>9</sub>H<sub>12</sub>N<sub>3</sub>Na<sub>2</sub>O<sub>8</sub>P 367.16

NC05637

50g	\$60.00
100g	\$95.00
250g	\$195.00

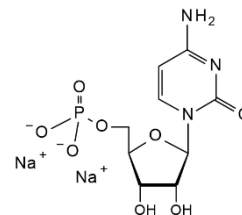
**Cytidine 5'-monophosphate free acid**[63-37-6] C<sub>9</sub>H<sub>14</sub>N<sub>3</sub>O<sub>8</sub>P 323.2

NC02951

100g	\$55.00
250g	\$125.00
500g	\$200.00

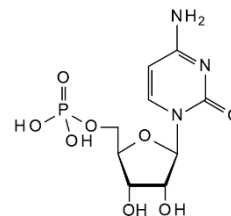

**Cytidine 3'-monophosphate lithium salt**

• 3'-Cytidylic acid lithium salt

[54874-07-6]  $C_9H_{14}N_3O_8P \cdot xLi$  323.20 (free acid basis)

NC46261

Price On Application

**Cytidine-2'-monophosphate sodium salt**• 2'-CMP  
• 2'-Cytidylic acid[81487-28-7][85-94-9]  $C_9H_{14}N_3O_8P \cdot xNa$  323.20 (free acid basis)

NC13474

1ug	\$250.00
3ug	\$585.00
8ug	\$1000.00

**Cytidine 5'-monophosphate sodium salt** $C_9H_{14}N_3O_8P \cdot xNa$  323.20 (free acid basis)

NC00007

25g	\$50.00
50g	\$85.00

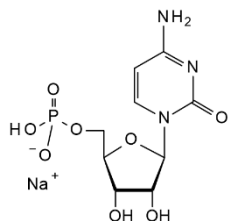
**Cytidine 3'(2')-monophosphate**• 3'(2')-Cytidylic acid  
• Ribocytidine 3'(2')-Monophosphate  
• 3'(2')-Cytosylic acid[84-52-6][81487-29-8][85-94-9][27214-06-8]  $C_9H_{14}N_3O_8P$  323.2

NC03937

5mg	\$60.00
10mg	\$95.00
25mg	\$175.00

**Cytidine-5'-phosphate-3'-(6-aminohexyl)phosphate-biotin triethylammonium salt - 1 mM aqueous solution (10 mM Tris-HCl)** $C_{25}H_{42}N_6O_{13}P_2S_1$  728.65

NC57576

Price On Application

**Cytidine-5'-O-(1-thiotriphosphate) lithium salt - 100mM aqueous solution**

• a-Thio-CTP

[118353-34-7]  $C_9H_{16}N_3O_{13}P_3S \cdot xLi$  499.22 (free acid basis)

NC58206

0.5ug	\$125.00
1ug	\$225.00
2ug	\$395.00

**Cytidine 5'-triphosphate disodium salt dihydrate**

• 5'-CTP-Na2

[81012-87-5]  $C_9H_{14}N_3O_{14}P_3 \cdot 2Na \cdot 2H_2O$  563.15

NC66105

100mg	\$50.00
250mg	\$100.00
500mg	\$180.00

**Cytidine 5'-triphosphate disodium salt**

• 5'-CTP-2Na

[36051-68-0][81012-87-5][652154-13-7][65-47-4]  $C_9H_{14}N_3Na_2O_{14}P_3$  527.12

NC03860

2g	\$60.00
5g	\$95.00
10g	\$160.00

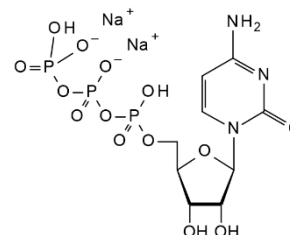

**Cytidinetrip****Cytidine-5'-triphosphate, lithium salt**

NC32076

Price On Application

**Cytidine-5'-triphosphate**

[123334-07-6]

NC44276

Price On Application

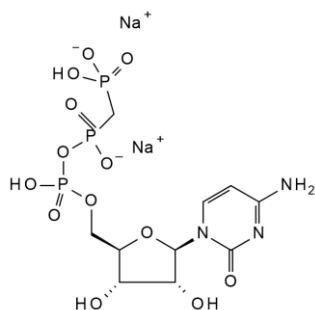
**Cytidine**

[65-46-3]

C<sub>9</sub>H<sub>13</sub>N<sub>3</sub>O<sub>5</sub>

243.22

NC04070

100g	\$60.00
250g	\$110.00
500g	\$200.00

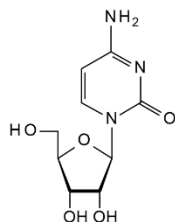

Refs: Matsuhashi S, Matsuhashi M, JL Strominger, J. Biol. Chem. 1966, Sept 25, 241(18), 4267-74

**L-Cytidine**

• 1-(β-L-ribofuranosyl)cytosine

[26524-60-7]

C<sub>9</sub>H<sub>13</sub>N<sub>3</sub>O<sub>5</sub>

243.22

NC02628

1g	\$63.00
2g	\$105.00
5g	\$157.50

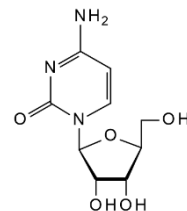

Refs: Verri A, Focher F, Priori G, Gosselin G, Imbach J-L, Capobianco M, Garbesi A, Spadari S, Mol. Pharmacol. 1997, Vol51, No1, p132-138

**Cytidyl-3'-5'-adenosine ammonium salt**

NC46046

1mg	\$475.00
2mg	\$925.00
5mg	\$1625.00

**Cytidyl-3'-5'-guanosine ammonium salt**

[2382-65-2]

C<sub>19</sub>H<sub>25</sub>N<sub>9</sub>O<sub>12</sub>P

588.42

NC59514

Price On Application

**3'-Cytidylic acid lithium salt**see *Cytidine 3'-monophosphate lithium salt, NC46261 on page 161***2'-Cytidylic acid**see *Cytidine 2'-monophosphate sodium salt, NC13474 on page 161***3'(2')-Cytidylic acid**see *Cytidine 3'(2')-monophosphate, NC03937 on page 161*

**Cytidyl-3'-5'-uridine ammonium salt**[27552-97-2] C<sub>18</sub>H<sub>24</sub>N<sub>6</sub>O<sub>13</sub>P·NH<sub>3</sub> 566.42

NC07990

1mg	\$525.00
2mg	\$945.00
5mg	\$1968.80

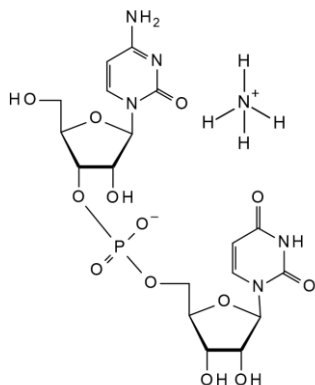
**Cytosine-b-D-arabinofuranoside**

see 1-(b-D-Arabinofuranosyl)cytosine, NA05771 on page 73

**Cytosine b-D-arabinofuranoside HCl**

see 1-(b-D-Arabinofuranosyl)cytosine HCl, NA05780 on page 73

**Cytosine b-D-arabinofuranoside 5'-monophosphate**

see 1-(b-D-Arabinofuranosyl)cytosine 5'-monophosphate, NA10080 on page 73

**Cytosine b-D-riboside hemisulfate salt**

see Cytidine hemisulfate salt, NC57355 on page 160

**3'(2')-Cytosylic acid**

see Cytidine 3'(2')-monophosphate, NC03937 on page 161

**3'-dA-CPG**

see N6-Benzoyl-3'-deoxy-5'-O-DMT-adenosine 2'-O-succinoyl-long chain alkylamino-CPG, NB39290 on page 99

**5'-dAMP free acid**

see 2'-Deoxyadenosine-5'-monophosphate free acid, ND05971 on page 171

**dAMP.2Na**

see 2'-Deoxyadenosine-5'-monophosphate disodium salt, ND15298 on page 171

**dAMP.Na**

see 2'-Deoxyadenosine 5'-monophosphate sodium salt, ND46696 on page 172

**N6-Dansylhexyl-5'-ethylcarboxamidoadenosine**

- 1-Deoxy-1-[6-[[[5-dimethylamino)-1-naphthalenyl]sulfonyl]amino]hexyl]amino]-9H-purin-9-yl]-N-ethyl-b-D-ribofuranuronamide
- Dansyl-NECA

[219982-12-4] C<sub>30</sub>H<sub>40</sub>N<sub>6</sub>O<sub>6</sub>S 640.75

ND59462

100mg	\$2400.00
250mg	\$4125.00
500mg	\$7250.00

**Dansyl-NECA**

see N6-Dansylhexyl-5'-ethylcarboxamidoadenosine, ND59462 on page 163

**DAPA**

see 2,6-Diamino-9-(b-D-arabinofuranosyl)purine, ND03400 on page 230

**dApCpp**

see 2'-Deoxyadenosine-5'-[(a,b)-methyleno]triphosphate sodium salt - 10 mM aqueous solution, ND46688 on page 171

**5'-dATP 2Na**

see 2'-Deoxyadenosine-5'-triphosphate disodium salt, ND04010 on page 172

**dATP**

see 2'-Deoxyadenosine-5'-triphosphate trisodium salt, ND05744 on page 172

**dATP - 100 mmol solution**[1927-31-7] C<sub>10</sub>H<sub>16</sub>N<sub>5</sub>O<sub>12</sub>P 429.23

ND46290

1mg	\$90.00
-----	---------



**DBcAMPNa****DB-cAMP . Na**

see *N*<sub>6</sub>,2'-*O*-Dibutyryladenine 3',5'-cyclic monophosphate sodium salt, ND07996 on page 235

**DBR**

see 5,6-Dichlorobenzimidazole-1-*b*-*D*-ribofuranoside, ND06701 on page 235

**5'-dCMP free acid**

see 2'-Deoxycytidine-5'-monophosphate free acid, ND02993 on page 175

**3'-dCMP.Na**

see 2'-Deoxycytidine-3'-monophosphate sodium salt, ND46691 on page 175

**5'-dCMPS**

see 2'-Deoxycytidine-5'-*O*-monophosphorothioate sodium salt, ND46694 on page 175

**3'-dCMP**

see 2'-Deoxycytidine-3'-monophosphate ammonium salt, ND46693 on page 174

**5'-dCTP Na3**

see 2'-Deoxycytidine-5'-triphosphate trisodium salt, ND05687 on page 176

**dCTPS**

see 2'-Deoxycytidine-5'-*O*-(1-thiotriphosphate) sodium salt - 10 mM aqueous solution, ND32069 on page 176

**dCTP - 100mmol solution**

[109909-44-6]    C<sub>9</sub>H<sub>16</sub>N<sub>5</sub>O<sub>13</sub>P<sub>3</sub>    467.16    1mg    \$90.00  
ND46291

**ddATP**

see 2',3'-Dideoxyadenosine-5'-triphosphate lithium salt - 100mM aqueous solution, ND32077 on page 240

**ddCTP**

see 2',3'-Dideoxycytidine-5'-triphosphate lithium salt - 100mM aqueous solution, ND32066 on page 240

**ddC**

see 2',3'-Dideoxycytidine, ND06559 on page 240

**dd-GTP**

see 2',3'-Dideoxyguanosine-5'-triphosphate lithium salt - 100mM aqueous solution, ND32065 on page 243

**DDI**

see 2',3'-Dideoxyinosine, ND02929 on page 244

**ddUTP**

see 2',3'-Dideoxyuridine-5'-triphosphate lithium salt - 100mM aqueous solution, ND10276 on page 246

**3-Deazaadenosine**

• 4-Amino-1-(*b*-*D*-ribofuranosyl)-1*H*-imidazo[4,5-*d*]-pyridine

[6736-58-9]    C<sub>11</sub>H<sub>14</sub>N<sub>4</sub>O<sub>4</sub>    266.26

ND04697    1mg    \$95.00  
2mg    \$170.00  
5mg    \$325.00

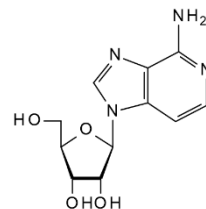

**Refs:** Biochem Biophys. Res. Comm. 1978, 84,1, p102; Flexner CW, et al, Lancet 1992, 339, p438; Proc. Natl. Acad. Sci. USA 1978, 75,12, p6220

**7-Deazaadenosine**

• Tubercidin

• 4-Amino-7-*b*-*D*-ribofuranosyl-7*H*-pyrrolo[2,3-*d*]pyrimidine

[69-33-0]    C<sub>11</sub>H<sub>14</sub>N<sub>4</sub>O<sub>4</sub>    266.26

ND06290    25mg    \$75.00  
50mg    \$112.50  
100mg    \$200.00

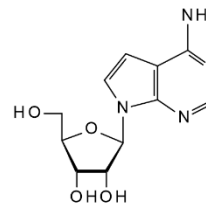
**7-Deaza-7-carbamoyladenosine**

see Sangivamycin, NS139064 on page 353



**7-Deaza-4-Cl-2'-deoxyguanosine**[104291-17-0] C<sub>11</sub>H<sub>13</sub>ClN<sub>4</sub>O<sub>3</sub> 284.7

ND57492

1g	\$800.00
2g	\$1400.00
5g	\$3000.00

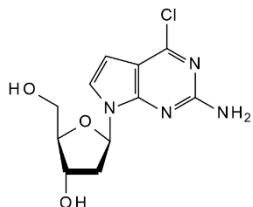
**7-Deaza-7-cyanoadenosine**see *Toyoamycin*, NT44985 on page 369**3-Deaza-2'-Deoxyadenosine**[78582-17-9] C<sub>11</sub>H<sub>14</sub>N<sub>4</sub>O<sub>3</sub> 250.25

ND57491

500mg	\$1295.00
1g	\$1750.00
2.5g	\$3500.00

**7-Deaza-2'-deoxyadenosine**

- 2-Deoxytubercidin
- 7-(2-Deoxy-β-D-erythro-pentofuranosyl)-7H-pyrrolo[2,3-d]pyrimidin-4-amine

[60129-59-1] C<sub>11</sub>H<sub>14</sub>N<sub>4</sub>O<sub>3</sub> 250.26

ND02936

50mg	\$90.00
100mg	\$150.00
250mg	\$325.00

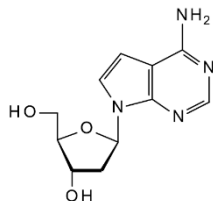

Refs: Seela F, Driller H, Helv. Chim. Acta 1988, Vol71, Issue 5, p1191-1198; Biochemistry 1987, 26, 8, p2232

**7-deaza-3'-deoxy-adenosine**

ND29525

Price On Application

**7-Deaza-2'-deoxy-5'-O-DMT-N2-isobutyrylguanosine**C<sub>38</sub>H<sub>38</sub>N<sub>4</sub>O<sub>7</sub> 638.73

ND08311

1g	\$525.00
2g	\$945.00
5g	\$1050.00

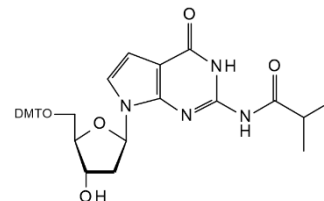
**7-Deaza-2'-deoxy-5'-O-DMT-xanthosine**

- 5'-O-DMT-7-deaza-2'-deoxyxanthosine
- 7-[5-O-[Bis(4-methoxyphenyl)phenylmethyl]-2-deoxy-β-D-erythro-pentofuranosyl]-1H-pyrrolo[2,3-d]pyrimidine-2,4(3H,7H)-dione

[869355-16-8] C<sub>32</sub>H<sub>31</sub>N<sub>3</sub>O<sub>7</sub> 569.6

ND10364

25mg	\$79.00
50mg	\$147.00
100mg	\$231.00

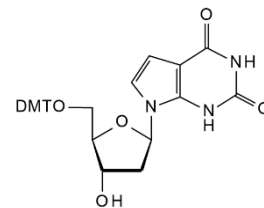

**Deazadeoxyet****7-Deaza-2'-deoxy-7-ethynyladenosine**C<sub>13</sub>H<sub>14</sub>N<sub>4</sub>O<sub>3</sub> 274.28

ND44812

0.5mg	\$300.00
1mg	\$550.00
2mg	\$1000.00

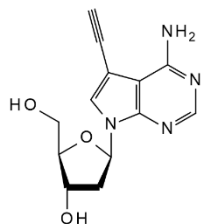
**7-Deaza-2'-deoxy-2'-fluoroguanosine**C<sub>11</sub>H<sub>14</sub>FN<sub>4</sub>O<sub>4</sub> 284.25

ND08348

Price On Application

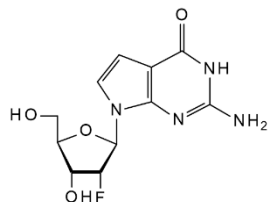
**7-Deaza-2'-deoxyguanosine-5'-triphosphate lithium salt - 100mM aqueous solution**

• 7-Deaza-dGTP.Li

[101515-08-6] C<sub>11</sub>H<sub>17</sub>N<sub>4</sub>O<sub>13</sub>P<sub>3</sub>·xLi 506.19 (free acid basis)

ND157323

500ug	\$125.00
1mg	\$225.00
2mg	\$410.00

**7-Deaza-2'-deoxyguanosine-5'-triphosphate sodium salt - 10mM aqueous solution**

• 7-Deaza-dGTP.Na

[101515-08-6] C<sub>11</sub>H<sub>17</sub>N<sub>4</sub>O<sub>13</sub>P<sub>3</sub>·xNa 506.19 (free acid basis)

ND157324

500ug	\$225.00
1mg	\$350.00
2mg	\$460.00

**7-Deaza-2'-deoxyguanosine**[86392-75-8] C<sub>11</sub>H<sub>14</sub>N<sub>4</sub>O<sub>4</sub> 266.26

ND02887

25mg	\$79.00
50mg	\$131.50
100mg	\$200.00

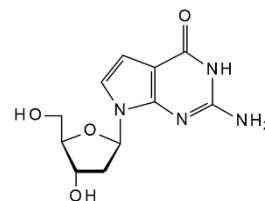

Refs: Seela F, Driller H, Helv. Chim. Acta 1988, Vol71, Issue 5, p1191-1198

**7-Deaza-2'-deoxyinosine**[97224-58-3] C<sub>11</sub>H<sub>13</sub>N<sub>3</sub>O<sub>4</sub> 251.24

ND06187

50mg	\$95.00
100mg	\$168.00
250mg	\$325.00

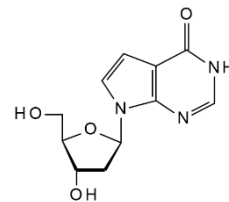

Refs: Loakes D, Nucleic Acids Res. 2001, Vol29, No12, p2437-2447



**7-Deaza-2'-deoxy-7-iodoadenosine**

• 2'-deoxy-7-iodotubercidin

[908130-61-0][166247-63-8] C<sub>11</sub>H<sub>13</sub>N<sub>4</sub>O<sub>3</sub> 376.16

ND06190

25mg	\$60.00
50mg	\$95.00
100mg	\$170.00

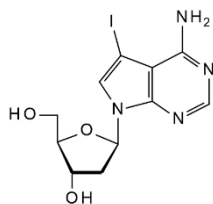

Refs: Seela F, Zulauf M, Chem. Eur. J. 1998, Vol4, No9, p1781-1790

**7-Deaza-2'-deoxy-7-iodoguanosine**[172163-62-1] C<sub>11</sub>H<sub>13</sub>N<sub>4</sub>O<sub>4</sub> 392.16

ND02147

25mg	\$75.00
50mg	\$110.00
100mg	\$180.00

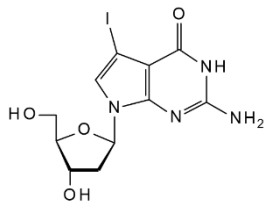

Refs: Ramzaeva N, Mittelbach C, Seela F, Helv. Chim. Acta Vol80, No6, p1809-1822

**7-Deaza-2'-deoxy-6-methoxyguanosine**[86392-74-7] C<sub>12</sub>H<sub>16</sub>N<sub>4</sub>O<sub>4</sub> 280.29

ND06168

50mg	\$94.50
100mg	\$158.00
250mg	\$342.50

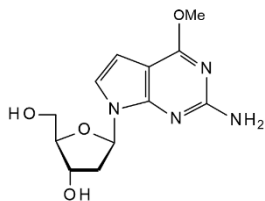
**7-Deaza-2'-deoxy-O6-methylguanosine**C<sub>12</sub>H<sub>16</sub>N<sub>4</sub>O<sub>4</sub> 280.28

ND31362

50mg	\$210.00
100mg	\$315.00
250mg	\$525.00

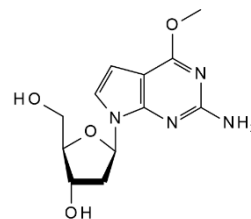
**7-Deaza-2'-deoxyxanthosine**[96022-82-1] C<sub>11</sub>H<sub>13</sub>N<sub>3</sub>O<sub>5</sub> 267.24

ND02491

5mg	\$78.80
10mg	\$136.50
25mg	\$210.00

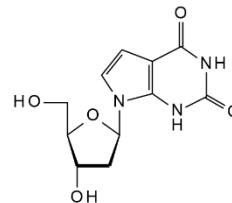
**7-Deaza-dGTP.Li**

see 7-Deaza-2'-deoxyguanosine-5'-triphosphate lithium salt - 100mM aqueous solution, ND157323 on page 166

**7-Deaza-dGTP.Na**

see 7-Deaza-2'-deoxyguanosine-5'-triphosphate sodium salt - 10mM aqueous solution, ND157324 on page 166

**7-Deaza-2',3'-dideoxyadenosine**

• 2',3'-dideoxytubercidin

[40627-30-3] C<sub>11</sub>H<sub>14</sub>N<sub>4</sub>O<sub>2</sub> 234.26

ND00041

5mg	\$75.00
10mg	\$125.00
25mg	\$210.00

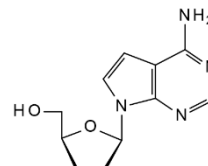

Refs: Seela F, Gumbiowski R, Helv. Chim. Acta 1991, Vol74, Issue 5, p1048-1058

**Deazadideoxy****7-Deaza-2',3'-dideoxyguanosine**C<sub>11</sub>H<sub>14</sub>N<sub>4</sub>O<sub>3</sub> 250.26

ND06191

2mg	\$42.00
5mg	\$63.00
10mg	\$89.30

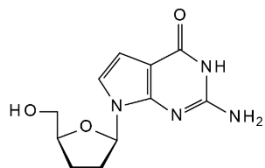

Refs: Seela F, Wei C, Helv. Chim. Acta 1999, Vol82, No5, p726-745

**7-Deaza-2',3'-dideoxy-7-iodoadenosine**

• 2'3'-dideoxy-7-iodotubercidin

[114748-70-8] C<sub>11</sub>H<sub>13</sub>I<sub>N</sub><sub>4</sub>O<sub>2</sub> 360.15

ND44800

2mg	\$60.00
5mg	\$100.00
10mg	\$160.00

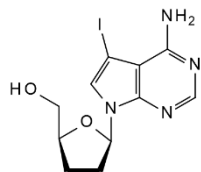
**7-Deaza-2',3'-dideoxy-7-iodoguanosine**[114748-67-3] C<sub>11</sub>H<sub>13</sub>N<sub>4</sub>O<sub>3</sub>I 376.15

NI57362

25mg	\$335.00
50mg	\$525.00
100mg	\$825.00

**7-Deaza-2'-C-ethynyladenosine**[1044589-82-3] C<sub>13</sub>H<sub>14</sub>N<sub>4</sub>O<sub>4</sub> 290.27

ND15347

Price On Application

**3-Deazaguanosine**[56039-11-3] C<sub>11</sub>H<sub>14</sub>N<sub>4</sub>O<sub>5</sub> 282.25

ND30048

Price On Application

**7-Deazaguanosine**

• 2-Amino-7-b-D-ribofuranosyl[3,2-d]pyrimidin-4-one

[62160-23-0] C<sub>11</sub>H<sub>14</sub>N<sub>4</sub>O<sub>5</sub> 282.26

ND05752

10mg	\$65.00
25mg	\$115.00
50mg	\$175.00

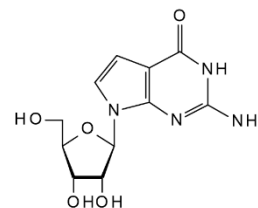

Refs: Watanabe M, Matsuo M, Tanaka S, Akimoto H, Asahi S, Nishimura S, Katze JR, Hashizume T, Crain PF, McCloskey JA, J. Biol. Chem. 1997, Vol272, No32, p20146-20151

**9-Deazaguanosine**

• 2-Amino-7-b-D-ribofuranosyl[3,2-d]pyrimidin-4-one

[102731-45-3] C<sub>11</sub>H<sub>14</sub>N<sub>4</sub>O<sub>5</sub> 282.25

ND06109

5mg	\$183.80
10mg	\$336.00
25mg	\$735.00

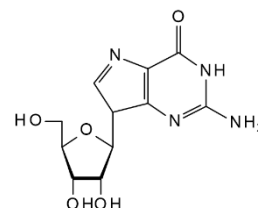

Refs: Lim MI, Ren WY, Otter BA, Klein RS, J. Org. Chem. 1983, Vol40, p780-788

**7-Deaza-7-iodoadenosine**

• 5-Iodotubercidin

[24386-93-4] C<sub>11</sub>H<sub>13</sub>N<sub>4</sub>O<sub>4</sub> 392.15

ND09248

1mg	\$102.70
2mg	\$158.12
5mg	\$253.50

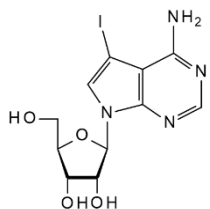

Refs: Parkinson, Geiger, J. Pharmacol. Exp. Ther, 1996, 277, p1397; Fluckiger-Isler et.al, Biochem. J, 1993, 292, p85

**7-Deaza-2-mercaptopyoxanthine**C<sub>6</sub>H<sub>5</sub>N<sub>3</sub>OS 167.19

ND10405

250mg	\$172.50
500mg	\$265.00
1g	\$420.00

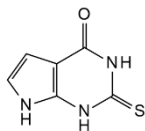
**7-Deaza-2'-C-methyladenosine**[443642-29-3] C<sub>12</sub>H<sub>16</sub>N<sub>4</sub>O<sub>4</sub> 280.29

ND08351

10mg	\$85.00
25mg	\$150.00
50mg	\$250.00

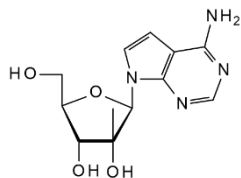
**7-Deaza-2'-C-methylguanosine**[443642-38-4] C<sub>12</sub>H<sub>16</sub>N<sub>4</sub>O<sub>5</sub> 296.29

ND08382

5mg	\$2100.00
10mg	\$3000.00
25mg	\$4000.00

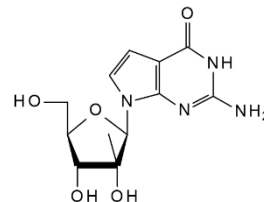
**7-Deaza-2'-C-methylinosine**C<sub>11</sub>H<sub>11</sub>N<sub>3</sub>O<sub>6</sub> 281.22

ND72433

10mg	\$75.00
25mg	\$125.00
50mg	\$200.00

**3-Deaza-2'-O-methyluridine**[57165-33-0] C<sub>11</sub>H<sub>15</sub>NO<sub>6</sub> 257.24

ND58308

Price On Application

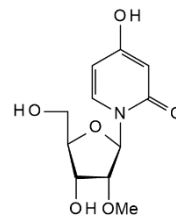
**3-Deaza-3'-O-methyluridine**

• 4-Hydroxy-1-(3-O-methyl-b-D-ribofuranosyl)-2(1H)-Pyridinone

C<sub>11</sub>H<sub>15</sub>NO<sub>6</sub> 257.24

ND58310

Price On Application



**Deazapurine****7-Deazapurine**[18549-65-0] C<sub>8</sub>H<sub>5</sub>N<sub>3</sub> 119.12

ND11318

50mg	\$105.00
100mg	\$179.00
250mg	\$315.00

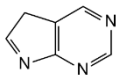

D

**7-Deaza-9-(β-D-ribofuranosyl)guanine**

ND145900

1mg	\$50.00
2mg	\$92.00
5mg	\$215.00

**3-Deazauridine 5'-O-triphosphate lithium salt - 100 mM aqueous solution**

• 4-Hydroxy-1-(5-O-triphosphoro-β-D-ribofuranosyl)-2(1H)-pyridinone

ND58306

Price On Application

**3-Deazauridine-5'-triphosphate sodium salt**C<sub>10</sub>H<sub>16</sub>NO<sub>15</sub>P<sub>3</sub>·xNa 483.15 (free acid basis)

ND74957

Price On Application

**3-Deazauridine-5'-triphosphate triethylamine salt**

ND74958

Price On Application

**3-Deazauridine**

- 4-Hydroxy-1-β-D-ribofuranosyl-2(1H)-pyridinone
- 1-β-D-Ribofuranosyl-4-hydroxy-2-pyridone
- 3-Deazauridine

[23205-42-7] C<sub>10</sub>H<sub>13</sub>NO<sub>6</sub> 243.21

ND16524

25mg	\$85.00
50mg	\$145.00
100mg	\$195.00

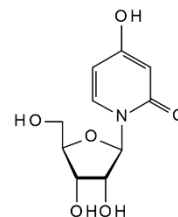
Refs: Teh, A.-H, et al, *Biochemistry*, 45, 7825 (2006)**Decanoyl coenzyme A, free acid**

- Capryl coenzyme A

[1264-57-9] C<sub>31</sub>H<sub>54</sub>N<sub>7</sub>O<sub>17</sub>P<sub>3</sub>S·H<sub>2</sub>O 939.8

ND47196

2mg	\$60.00
5mg	\$123.00
10mg	\$205.10

**Decitabine**

see 5-Aza-2'-deoxycytidine, NA02969 on page 78

**2',3'-Dehydro-5'-O-tritylthymidine**

• 5-Methyl-1-(5-tritylmethyl-2,5-dihydro-furan-2-yl)-1H-pyrimidine-2,4-dione

[5964-41-0] C<sub>29</sub>H<sub>26</sub>N<sub>2</sub>O<sub>4</sub> 466.54

ND04743

25mg	\$89.50
50mg	\$157.50
100mg	\$263.00

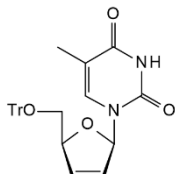
**Dendrid**

see 2'-Deoxy-5-iodouridine, ND05147 on page 210

**Denufosal**

see 2'-Deoxycytidine P'''-5'-ester with uridine 5'-(pentahydrogen tetraphosphate) sodium salt, ND45968 on page 175

**3'-Deoxyadenosine CPG**

ND11640

100mg \$525.00

**2'-Deoxyadenosine-5'-diphosphate sodium salt**[72003-83-9] C<sub>10</sub>H<sub>12</sub>N<sub>5</sub>O<sub>8</sub>P<sub>2</sub>·xNa 408.18 (free acid basis)

ND13490

25mg	\$150.00
50mg	\$200.00
100mg	\$320.00

**2'-Deoxyadenosine-5'-[(a,b)-methylene]triphosphate sodium salt - 10 mM aqueous solution**

• dApCpP

[138998-91-1 (free acid)] C<sub>11</sub>H<sub>18</sub>N<sub>5</sub>O<sub>11</sub>P<sub>3</sub>·xNa 489.21 (free acid basis)

ND46688

250ug	\$225.00
500ug	\$350.00
1mg	\$600.00

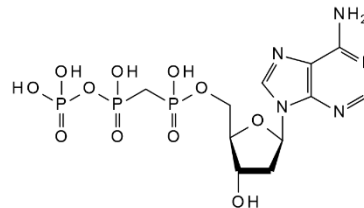
**2'-Deoxyadenosine-5'-monophosphate disodium salt**

• dAMP·2Na

[2922-74-9] C<sub>10</sub>H<sub>12</sub>N<sub>5</sub>Na<sub>2</sub>O<sub>6</sub>P 375.19

ND15298

500mg	\$90.00
1g	\$160.00
2g	\$300.00

**2'-Deoxyadenosine-5'-monophosphate free acid**

• 5'-dAMP free acid

[653-63-4] C<sub>10</sub>H<sub>14</sub>N<sub>5</sub>O<sub>6</sub>P 331.23

ND05971

2g	\$52.50
5g	\$100.00
10g	\$160.00

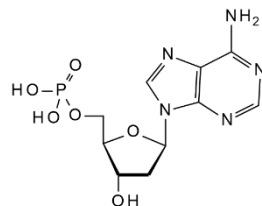

**Deoxyadenosi****2'-Deoxyadenosine-3'-monophosphate sodium salt**[102832-10-0] C<sub>10</sub>H<sub>14</sub>N<sub>5</sub>O<sub>6</sub>P·Na 351.21

ND05758

1mg	\$75.00
2mg	\$130.00
5mg	\$225.00

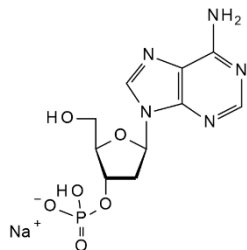
**2'-Deoxyadenosine-5'-triphosphate disodium salt**

• 5'-dATP 2Na

[74299-50-6] C<sub>10</sub>H<sub>14</sub>N<sub>5</sub>O<sub>12</sub>P<sub>3</sub>·Na<sub>2</sub> 535.15

ND04010

25mg	\$210.00
50mg	\$275.00
100mg	\$500.00

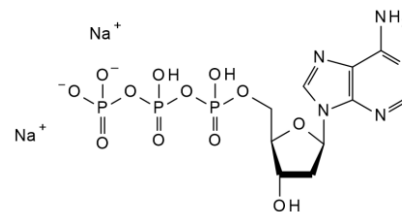
**2'-Deoxyadenosine 5'-monophosphate sodium salt**

- 2'-Deoxyadenylic acid
- dAMP·Na

[151151-31-4] C<sub>10</sub>H<sub>14</sub>N<sub>5</sub>O<sub>6</sub>P·xNa 331.22 (free acid basis)

ND46696

250mg	\$60.00
500mg	\$95.00
1g	\$165.00

**2'-Deoxyadenosine-5'-triphosphate trisodium salt**

• dATP

[1927-31-7] C<sub>10</sub>H<sub>13</sub>N<sub>5</sub>O<sub>12</sub>P<sub>3</sub>·3Na 557.13

ND05744

100mg	\$95.00
250mg	\$175.00
500mg	\$300.00

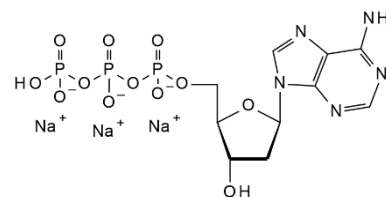
**2'-Deoxyadenosine-5'-O-(1-thiotriphosphate) lithium salt - 100 mM aqueous solution**

• a-Thio-dATP

[80875-87-2] C<sub>10</sub>H<sub>16</sub>N<sub>5</sub>O<sub>11</sub>P<sub>3</sub>S·xLi 507.25 (free acid basis)

ND32070

2mg	\$525.00
5mg	\$787.50

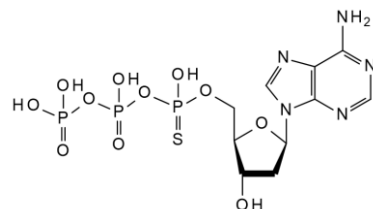
**3'-Deoxyadenosine-5'-triphosphate**

ND71670

Price On Application

**2'-Deoxy-a-adenosine**[958-09-8] C<sub>10</sub>H<sub>13</sub>N<sub>5</sub>O<sub>3</sub> 251.25

ND08541

10mg	\$65.00
25mg	\$85.00
50mg	\$150.00

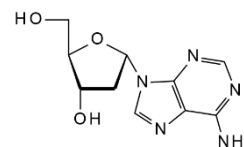



**2'-Deoxy-L-adenosine**

• 9-(2-Deoxy-b-L-erythro-pentofuranosyl)adenine

[14365-45-8] C<sub>10</sub>H<sub>13</sub>N<sub>5</sub>O<sub>3</sub> 251.25

ND04246

500mg	\$95.00
1g	\$175.00
2g	\$310.00

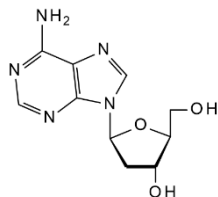

Refs: Fujimori S, et al, Nucleoside &amp; Nucleotide 1992, 11(2-4), p341

**2'-Deoxyadenosine**

• 9-(2-Deoxy-b-D-ribofuranosyl)adenine

[16373-93-6][958-09-8] C<sub>10</sub>H<sub>13</sub>N<sub>5</sub>O<sub>3</sub> 251.24

ND04011

25g	\$60.00
50g	\$100.00
100g	\$175.00

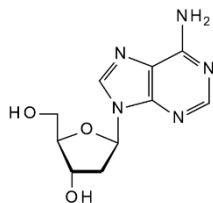

Refs: Kazimierzuk Z, Cottam HB, Revankar GR, Robins RK, J. Am. Chem. Soc. 1984, Vol106, p6379-6382

**3'-Deoxyadenosine**

- Cordycepin
- Adenine-9,3-deoxy-b-D-erythro-pentofuranoside
- 9-Cordyceposidoadenine

[73-03-0] C<sub>10</sub>H<sub>13</sub>N<sub>5</sub>O<sub>3</sub> 251.25

ND02930

100mg	\$75.00
250mg	\$145.00
500mg	\$220.00

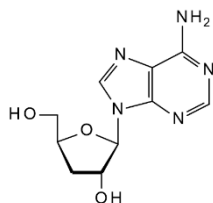

Refs: Norman DG, Reese CB, Synthesis 1983, p304-306

**5'-Deoxyadenosine**[4754-39-6] C<sub>10</sub>H<sub>13</sub>N<sub>5</sub>O<sub>3</sub> 251.25

ND02599

10mg	\$75.00
25mg	\$125.00
50mg	\$195.00

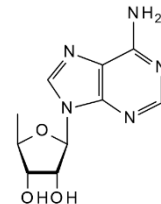
**S-(5'-Deoxyadenosin-5'-yl)-L-homocysteine**see *S-(5'-Adenosyl)-L-homocysteine dihydrate*, NA17223 on page 28**2'-Deoxyadenylic acid**see *2'-Deoxyadenosine 5'-monophosphate sodium salt*, ND46696 on page 172**1-(2-Deoxy-b-D-erythro-pentofuranosyl)-1H-pyrazolo[3,4-d]pyrimidin-4-amine**see *8-Aza-7-deaza-2'-deoxyadenosine*, NA141793 on page 77**2'-Deoxy-5-bromouridine**see *5-Bromo-2'-deoxyuridine*, NB06315 on page 126**1-(2'-Deoxy-2'-chloro-b-L-arabinofuranosyl)-thymine**C<sub>10</sub>H<sub>13</sub>ClN<sub>2</sub>O<sub>5</sub> 276.67

ND58414

25mg	\$113.75
50mg	\$182.00
100mg	\$291.00

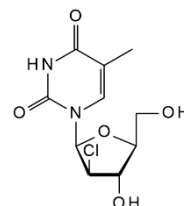

**DeoxyChloroc****2'-Deoxy-5-Chlorocytidine**

ND64914	1mg	\$50.00
	2mg	\$80.00
	5mg	\$150.00

**5'-Deoxy-5-chloro-D-cytidine**

see *5-Chloro-5'-deoxycytidine*, NC06308 on page 142

**5'-Deoxy-5-chloro-D-uridine**

see *5-Chloro-5'-deoxyuridine*, NC04680 on page 145

**3'-Deoxy-3'-C-methylguanosine**

see *3'-Deoxy-3'-methylguanosine*, ND144927 on page 215

**2'-DeoxyCTP trisodium**

see *2'-Deoxycytidine-5'-triphosphate trisodium salt*, ND16676 on page 176

**1-(2-Deoxy-2-cyano-b-D-arabinofuranosyl)cytosine**

see *Sapacitabine*, NS29828 on page 353

**2'-Deoxycytidine-5'-diphosphate trisodium salt hydrate**

[151151-32-5]  $C_9H_{12}N_3O_{10}P_2 \cdot Na_3$  453.12

ND16677	5mg	\$45.00
	10mg	\$70.00
	25mg	\$105.00

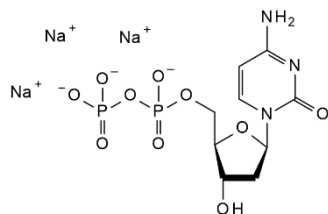

Refs: Zaharko, D.S. et al, J. Nat. Cancer Inst, 71, 1033 (1983); Terai, C. et al, Exp. Cell. res, 193, 375 (1991)

**2'-Deoxycytidine HCl**

[3992-42-5]  $C_9H_{13}N_3O_4 \cdot HCl$  263.68

ND02591	5g	\$40.00
	10g	\$55.00
	25g	\$120.00

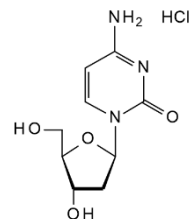

Refs: Subramanian E, Hunt DJ, Struct. Crystallogr. Cryst. Chem. B26, 303-311

**2'-Deoxycytidine-3'-monophosphate ammonium salt**

• 3'-dCMP

[102783-50-6]  $C_9H_{14}N_3O_7P \cdot 2NH_3$  341.26

ND46693	25mg	\$725.00
	50mg	\$1125.00
	100mg	\$1850.00

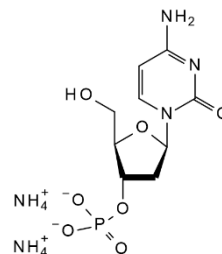
**2'-Deoxycytidine-5'-monophosphate disodium salt**

• Deoxycytidylic acid sodium salt

[13085-50-2]  $C_9H_{12}N_3O_7PNa_2$  351.16

ND13487	100mg	\$35.00
	250mg	\$50.00
	500mg	\$75.00



**2'-Deoxycytidine-3'-monophosphate free acid**[6220-63-9] C<sub>9</sub>H<sub>14</sub>N<sub>3</sub>O<sub>7</sub>P 307.2

ND46720

5mg	\$175.00
10mg	\$300.00
25mg	\$625.00

**2'-Deoxycytidine-5'-monophosphate free acid**

• 5'-dCMP free acid

[1032-65-1] C<sub>9</sub>H<sub>14</sub>N<sub>3</sub>O<sub>7</sub>P 307.2

ND02993

1g	\$60.00
2g	\$110.00
5g	\$225.00

**2'-Deoxycytidine-3'-monophosphate sodium salt**

• 3'-dCMP.Na

[102814-05-1] C<sub>9</sub>H<sub>12</sub>N<sub>3</sub>O<sub>7</sub>P·2Na 351.16

ND46691

Price On Application

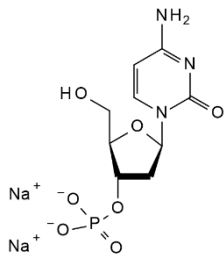
**2'-Deoxycytidine-5'-O-monophosphorothioate sodium salt**

- 2'-Deoxycytidine-5'-(α-thio)-monophosphate sodium salt
- 5'-dCMPS

[63225-09-2] C<sub>9</sub>H<sub>14</sub>N<sub>3</sub>O<sub>6</sub>PS 323.26

ND46694

1mg	\$195.00
2mg	\$350.00
5mg	\$625.00

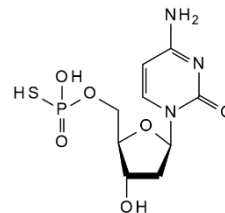
**2'-Deoxycytidine P'''-5'-ester with uridine 5'-(pentahydrogen tetraphosphate) sodium salt**

- Denufosol
- Uridine 5'-(pentahydrogen tetraphosphate), P'5'-ester 2'-deoxycytidine

[318250-11-2] C<sub>18</sub>H<sub>23</sub>N<sub>5</sub>Na<sub>4</sub>O<sub>21</sub>P<sub>4</sub> 861.25

ND45968

1mg	\$1250.00
2mg	\$1900.00
5mg	\$4125.00

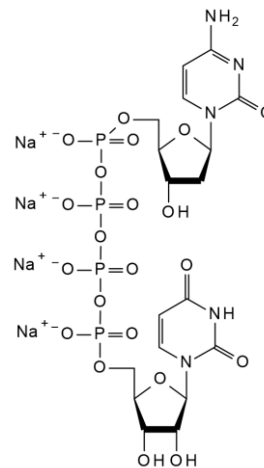
**2'-Deoxycytidine 5'-(tetrahydrogen triphosphate) trisodium salt**

see 2'-Deoxycytidine-5'-triphosphate trisodium salt, ND16676 on page 176

**2'-Deoxycytidine-5'-(α-thio)-monophosphate sodium salt**

see 2'-Deoxycytidine-5'-O-monophosphorothioate sodium salt, ND46694 on page 175

**Deoxycytidin****2'-Deoxycytidine-5'-O-(1-thiotriphosphate) lithium salt**[80951-75-3 (free acid)]  $C_9H_{16}N_3O_{12}P_3S \cdot Li_4$  506.95

Price On Application

ND58204

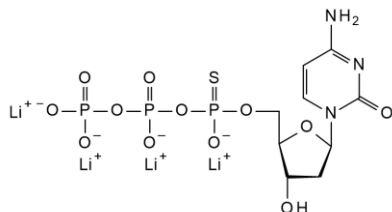
**2'-Deoxycytidine-5'-O-(1-thiotriphosphate) sodium salt - 10 mM aqueous solution**

- 2'-Deoxycytidine-5'-(a-thio)-triphosphate sodium salt
- dCTPS

[64145-29-5]  $C_9H_{16}N_3O_{12}P_3S \cdot xNa$  483.22 (free acid basis)

ND32069

1mg	\$375.00
2mg	\$625.00
5mg	\$1250.00

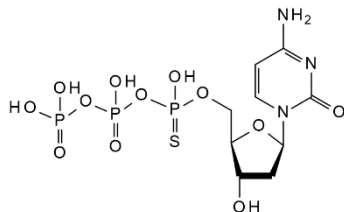
**2'-Deoxycytidine-5'-(a-thio)-triphosphate sodium salt**

see 2'-Deoxycytidine-5'-O-(1-thiotriphosphate) sodium salt - 10 mM aqueous solution, ND32069 on page 176

**2'-Deoxycytidine-5'-triphosphate trisodium salt**

- 5'-dCTP Na3
- 2'-Deoxy-5'-triphosphocytidine trisodium salt

[109909-44-6]  $C_9H_{13}N_3O_{13}P_3 \cdot 3Na$  533.11

ND05687

50mg	\$80.00
100mg	\$125.00
250mg	\$210.00

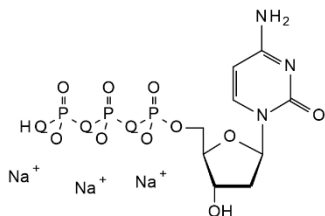
**2'-Deoxycytidine-5'-triphosphate trisodium salt**

- 2'-Deoxycytidine 5'-(tetrahydrogen triphosphate) trisodium salt
- 2'-DeoxyCTP trisodium
- 2'-Deoxycytidine 5'-triphosphate trisodium

[102783-51-7 (disodium salt)]  $C_9H_{13}N_3O_{13}P_3 \cdot Na_3$  533.1

ND16676

10mg	\$60.00
25mg	\$106.25
50mg	\$170.00

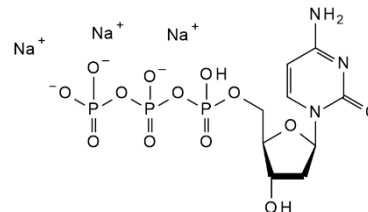

Refs: Guittet, O, et al, J. Biol. Chem, 276, 40647 (2001); Hakansson, P, et al, J. Biol. Chem, 281, 7834 (2006); Rampazzo, C, et al, Mutat. Res, 703, 2 (2010)

**2'-Deoxycytidine 5'-triphosphate trisodium**

see 2'-Deoxycytidine-5'-triphosphate trisodium salt, ND16676 on page 176

**3'-Deoxycytidine-5'-triphosphate**

ND71668

Price On Application

**2'-Deoxy-L-cytidine 3'-O-L-valinyl ester 2HCl**

- Valtorcitabine

[380886-95-3][359689-54-6]  $C_{14}H_{22}N_4O_5 \cdot 2HCl$  399.27

ND10527

1mg	\$75.00
2mg	\$110.00
5mg	\$175.00

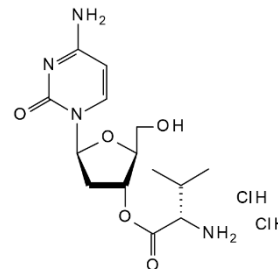

**2'-Deoxy-a-cytidine**C<sub>19</sub>H<sub>13</sub>N<sub>3</sub>O<sub>4</sub> 227.22

ND08527

50mg	\$150.00
100mg	\$185.00
250mg	\$350.00

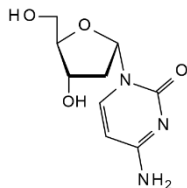
**3'-Deoxycytidine**[7057-33-2] C<sub>9</sub>H<sub>13</sub>N<sub>3</sub>O<sub>4</sub> 227.22

ND06564

10mg	\$67.00
25mg	\$150.00
50mg	\$275.00

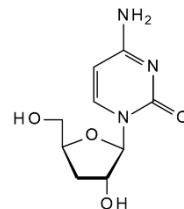

Refs: King RW, Zecher M, Jefferies MW, Antiviral Chem. Chemother. 2002, Vol13, Pt6, p363-370

**2'-Deoxy-L-cytidine**

• 1-(2-Deoxy-b-L-erythro-pentofuranosyl)cytosine

[40093-94-5] C<sub>9</sub>H<sub>13</sub>N<sub>3</sub>O<sub>4</sub> 227.22

ND05747

50mg	\$75.00
100mg	\$125.00
200mg	\$190.00

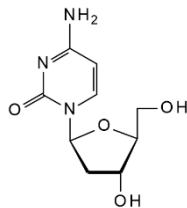

Refs: Clinch K, Evans GB, Fleet GWJ, Fumeaux RH, Johnson SW, Lenz DH, Mee SPH, Rands PR, Schramm VL, Taylor EA, Tyler PC, Org. &amp; Biomol. Chem. 2006, 4, 1131-1139

**2'-Deoxycytidine**[951-77-9] C<sub>9</sub>H<sub>13</sub>N<sub>3</sub>O<sub>4</sub> 227.22

ND06286

10g	\$45.00
25g	\$60.00
50g	\$100.00

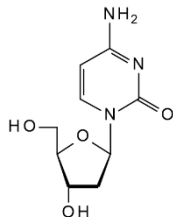

Refs: Xu H, Maga G, Focher F, Smith ER, J. Med. Chem. 1995, Vol38, No1, p49

**2'-Deoxycytidyl-(3'-5')-2'-deoxyguanosine**[77710-57-7] C<sub>19</sub>H<sub>25</sub>N<sub>6</sub>O<sub>10</sub>P.NH<sub>3</sub> 573.45

ND10434

1mg	\$585.00
2mg	\$890.00
5mg	\$1750.00

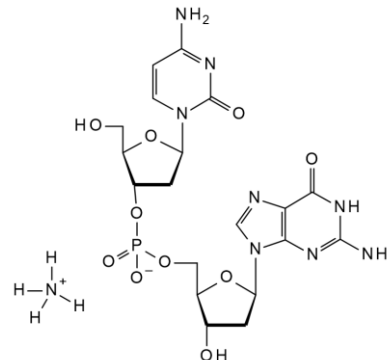
**Deoxycytidylic acid sodium salt**

see 2'-Deoxycytidine-5'-monophosphate disodium salt, ND13487 on page 174

**2'-Deoxy-7-deazaisoguanosine triphosphate**

• 4-Amino-7-[2-deoxy-5-O-[hydroxy[[hydroxy(phosphonoxy)phosphinyloxy]phosphinyloxy]phosphinyloxy]phosphinyloxy]-b-D-erythro-pentofuranosyl]-1,7-dihydro-2H-pyrrolo[2,3-d]pyrimidin-2-one

[151520-86-4] C<sub>11</sub>H<sub>17</sub>N<sub>4</sub>O<sub>13</sub>P<sub>3</sub> 506.19

ND139290

Price On Application



**Deoxydichlor****2'-Deoxy-3,5-di-O-p-chlorobenzoyl-a-D-ribofuranosyl-5-fluorouracil**see *3',5'-Di-O-p-chlorobenzoyl-2'-deoxy a-5-fluorouridine*, ND22464 on page 236**3'-deoxy-3',4'-didehydrouridine**C<sub>9</sub>H<sub>10</sub>N<sub>2</sub>O<sub>5</sub> 226.19

ND32094

10g

\$4300.00

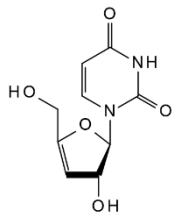
**2'-Deoxy-2',2'-difluorocytidine hydrochloride**

• Gemcitabine HCl

[122111-03-9] C<sub>9</sub>H<sub>11</sub>F<sub>2</sub>N<sub>3</sub>O<sub>4</sub>·HCl 299.66

ND09343

1g

\$50.00

2g

\$80.00

5g

\$125.00

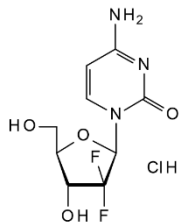
**2'-Deoxy-2',2'-difluorocytidine 5'-monophosphate triethylammonium salt**

• Gemcitabine 5'-monophosphate triethylammonium salt

ND15970

2mg

\$735.00

5mg

\$1522.50

10mg

\$2730.00

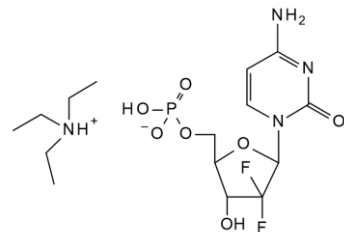
**2'-Deoxy-2',2'-difluorocytidine 5'-(9E)-9-octadecenoate**see *Gemcitabine 5'-elaidate*, NC05399 on page 281**2'-Deoxy-2',2'-difluorocytidine 5'-triphosphate triethylammonium salt - Aqueous solution**• Gemcitabine-5'-triphosphate triethylammonium salt  
• dFdCTPC<sub>9</sub>H<sub>14</sub>F<sub>2</sub>N<sub>3</sub>O<sub>13</sub>P<sub>3</sub>·C<sub>24</sub>H<sub>60</sub>N<sub>4</sub> 907.9

ND09708

1mg

\$195.00

2mg

\$350.00

5mg

\$625.00

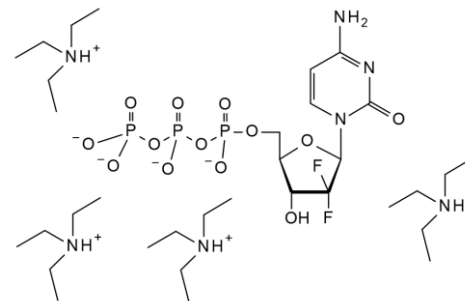
**2'-Deoxy-2',2'-difluorocytidine**

• Gemcitabine base

• 4-Amino-1-[3,3-difluoro-4-hydroxy-5-(hydroxymethyl)oxolan-2-yl]pyrimidin-2-one

[95058-81-4] C<sub>9</sub>H<sub>11</sub>F<sub>2</sub>N<sub>3</sub>O<sub>4</sub> 263.2

ND04237

1g

\$30.00

2g

\$50.00

5g

\$80.00

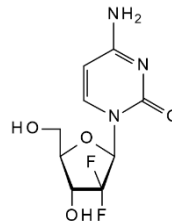

Refs: Grunewald R, Abbruzzese JL, Tarassoff P, Plunkett W, Cancer Chemotherapy and Pharmacology 1991, Vol27, No4, p258-262

**[1-(2-Deoxy-2,2-difluoro-b-D-erythro-pentofuranosyl)-1,2-dihydro-2-oxo-4-pyrimidinyl]- carbamic acid phenylmethyl ester**see *N-Cbz gemcitabine*, NC16645 on page 138

**2'-Deoxy-2',2'-difluoro-5-methyluridine**

• 2',2'-Difluorothymidine

[95058-80-3] C<sub>10</sub>H<sub>12</sub>F<sub>2</sub>N<sub>2</sub>O<sub>5</sub> 278.21

ND21055

Price On Application

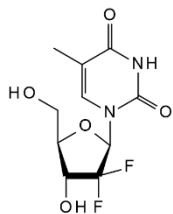

Refs: Barchi, J, et al, J. Biochem. Biophys. Methods, 34, 11 (1997)

**2'-Deoxy-2',2'-difluoro-N-[(phenylmethoxy)carbonyl]-cytidine**see *N-Cbz gemcitabine*, NC16645 on page 138**2'-Deoxy-2',2'-difluorouridine (13C,15N) labelled**C<sub>6</sub><sup>13</sup>CH<sub>10</sub>F<sub>2</sub><sup>15</sup>N<sub>2</sub>O<sub>5</sub> 297.16

ND16144

1mg

\$315.00

**2'-Deoxy-2',2'-difluorouridine 5'-triphosphate triethylammonium salt**

ND31415

Price On Application

**2'-Deoxy-2',2'-difluoro-a-uridine**[153381-14-7] C<sub>9</sub>H<sub>10</sub>F<sub>2</sub>N<sub>2</sub>O<sub>5</sub> 264.18

ND10802

1mg

\$63.00

2mg

\$99.80

5mg

\$183.80

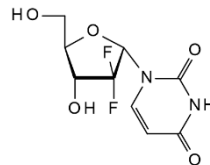
**2'-Deoxy-7,8-dihydro-8-oxo-adenosine**see *2'-Deoxy-8-oxo-adenosine*, ND02928 on page 217**2'-Deoxy-5'-dimethoxytrityl-N-isobutyryl-guanosine-3'-[(B-thiobenzoyl)-(1-pyrrolidinyl)]-thiophosphoramidite**see *2'-Deoxy-3'-O-DMT-N2-isobutyrylguanosine 5'-thiophosphoramidite*, ND46056 on page 186**1-Deoxy-1-[6-[[[5-dimethylamino]-1-naphthalenyl]sulfonyl]amino]hexyl]amino]-9H-purin-9-yl]-N-ethyl-b-D-ribofuranuronamide**see *N6-Dansylhexyl-5'-ethylcarboxamidoadenosine*, ND59462 on page 163**3'-Deoxy-2'-O-[(1,1-dimethylethyl)dimethylsilyl]-5'-O-(triphenylmethyl)uridine**see *2'-O-(tert-Butyldimethylsilyl)-3'-deoxy-5'-O-trityluridine*, NB16513 on page 130**2'-Deoxy-3',5'-bis-O-[(1,1-dimethylethyl)dimethylsilyl]uridine**see *3',5'-Bis-O-(tert-butyldimethylsilyl)-2'-deoxyuridine*, NB18821 on page 121**3'-Deoxy-N-dimethylformamide- 5'-O-DMT-guanosine-2'-O-succinoyl-long chain alkylamino-CPG**

• 3'-dG-CPG

ND37120

Price On Application



## DeoxydiTBDMMS

## 2'-Deoxy-3',5'-di-O-TBDMS-uridine

ND32635

Price On Application



## 1-(2'-Deoxy-3',5'-di-O-toluoyl-a-D-ribofuranosyl)-4-amino-1,2-dihydro-2-oxo-1,3,5-triazine

[40789-35-3] C<sub>24</sub>H<sub>24</sub>N<sub>4</sub>O<sub>6</sub> 464.48

ND06772

5mg	\$89.30
10mg	\$157.50
25mg	\$262.50

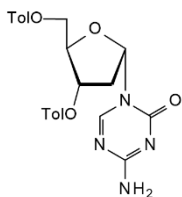

## 1-(2'-Deoxy-3',5'-di-O-toluoyl-b-D-ribofuranosyl)-4-amino-1,2-dihydro-2-oxo-1,3,5-triazine

- 4-Amino-1-[2-deoxy-3,5-bis-O-(4-methylbenzoyl)-β-D-erythro-pentofuranosyl]-1,3,5-triazin-2(1H)-one

[10302-79-1] C<sub>24</sub>H<sub>24</sub>N<sub>4</sub>O<sub>6</sub> 464.48

ND04704

5mg	\$89.30
10mg	\$157.50
25mg	\$262.50

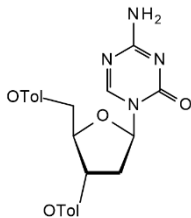

## 1-(2'-Deoxy-3',5'-di-O-toluoyl-D-ribofuranosyl)-4-amino-1,3-dihydro-2-oxo-1,3,5-triazine

C<sub>24</sub>H<sub>24</sub>N<sub>4</sub>O<sub>6</sub> 464.48

ND04706

5mg	\$89.30
10mg	\$157.50
25mg	\$262.50

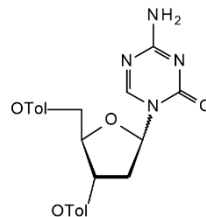

## 2-Deoxy-3,5-di-O-toluoyl-a-D-ribofuranosyl cyanide

ND145747

1g	\$50.00
2g	\$92.00
5g	\$210.00



## 6-(2-Deoxy-3,5-di-O-toluoyl-b-D-ribofuranosyl)-3,4-dihydro-8H-pyrimido[4,5-c][1,2]oxazin-7-one

[126128-41-4] C<sub>27</sub>H<sub>27</sub>N<sub>3</sub>O<sub>7</sub> 505.52

ND145588

50mg	\$120.00
100mg	\$195.00
250mg	\$375.00



## 2'-Deoxy-6N-DMF-5'-O-DMT-adenosine

- 5'-O-[[bis(4-methoxyphenyl)phenylmethyl]-2'-deoxy-N-[(dimethylamino)methylene]-adenosine

[17331-20-3] C<sub>34</sub>H<sub>36</sub>N<sub>6</sub>O<sub>5</sub> 608.69

ND146470

5g	\$625.00
10g	\$850.00
25g	\$1625.00





**2'-Deoxy-N2-DMF-5'-DMT-2'-fluoroguanosine 3'-CE phosphoramidite**C<sub>43</sub>H<sub>52</sub>FN<sub>6</sub>O<sub>7</sub>P 842.89

ND63471

1g	\$150.00
2g	\$250.00
5g	\$475.00

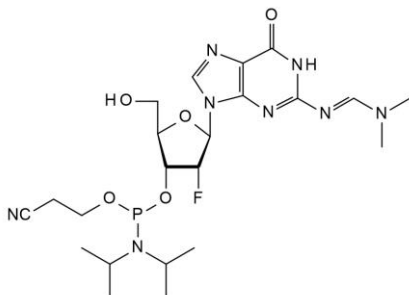
**2'-Deoxy-N2-DMF-5'-O-DMT-guanosine**

• 2'-Deoxy-5'-O-DMT-N2-(dimethylamino)methylidene-D-guanosine

[172361-60-3] C<sub>34</sub>H<sub>36</sub>N<sub>6</sub>O<sub>6</sub> 624.7

ND08309

1g	\$50.00
2g	\$78.00
5g	\$155.00

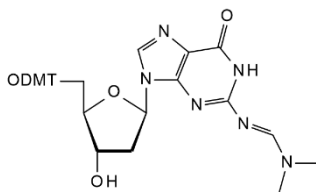
**3'-Deoxy-N2-DMF-5'-O-DMT-guanosine**

• 5'-O-(Dimethoxytrityl)-N2-(dimethylaminomethylidene)-3'-deoxyguanosine

[172361-60-3] C<sub>34</sub>H<sub>36</sub>N<sub>6</sub>O<sub>6</sub> 624.69

ND31008

25mg	\$236.50
50mg	\$394.00
100mg	\$578.00

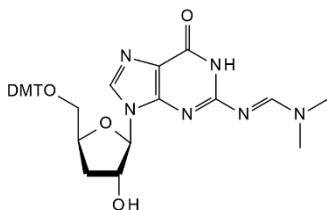
**2'-Deoxy-N2-DMF-guanosine**

• DMF-dG

[17331-13-4] C<sub>13</sub>H<sub>18</sub>N<sub>6</sub>O<sub>4</sub> 322.33

ND10841

2g	\$50.00
5g	\$90.00
10g	\$150.00

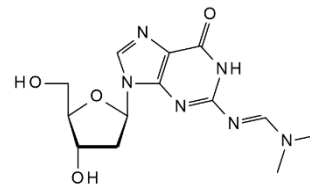
**2'-Deoxy-N2-DMF-5'-O-MMT-guanosine**C<sub>33</sub>H<sub>34</sub>N<sub>6</sub>O<sub>5</sub> 594.66

ND10514

Price On Application

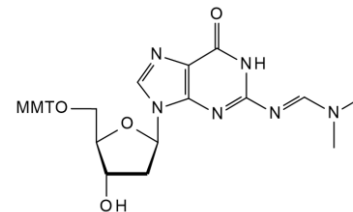
**2'-Deoxy-N2-DMF-5'-O-tritylguanosine**C<sub>32</sub>H<sub>32</sub>N<sub>6</sub>O<sub>4</sub> 564.65

ND09133

Price On Application

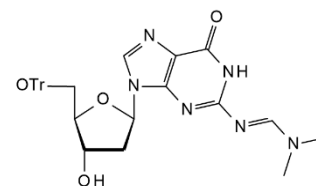
**2'-Deoxy-5'-O-DMT-adenosine**

ND145905

25mg	\$50.00
50mg	\$85.00
100mg	\$150.00



## DeoxyDMTtime

**2'-Deoxy-5'-O-DMT-N2-(dimethylamino)methylidene-D-guanosine**

see 2'-Deoxy-N2-DMF-5'-O-DMT-guanosine, ND08309 on page 181

**9-(2'-Deoxy-5'-O-DMT-2'-fluoro-b-D-arabinofuranosyl)-N2-isobutrylguanine 3'-O-succinate triethylammonium salt**C<sub>39</sub>H<sub>39</sub>FN<sub>5</sub>O<sub>10</sub>·C<sub>6</sub>H<sub>16</sub>N 858.97

ND09136

10mg	\$262.50
25mg	\$472.50
50mg	\$892.50

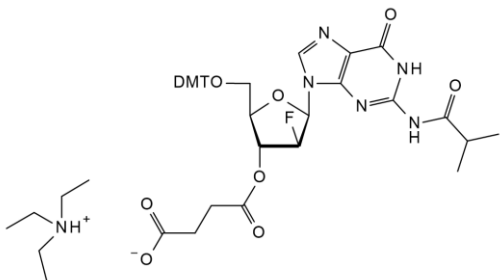
**9-(2'-Deoxy-5'-O-DMT-2'-fluoro-b-D-arabinofuranosyl)-N2-isobutrylguanine**C<sub>35</sub>H<sub>36</sub>FN<sub>5</sub>O<sub>7</sub> 657.69

ND09135

5mg	\$189.00
10mg	\$315.00
25mg	\$525.00

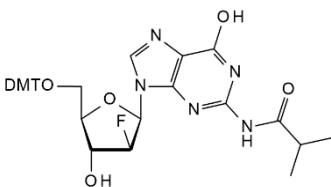
**1-(2'-Deoxy-5'-O-DMT-2'-fluoro-b-D-arabinofuranosyl)thymine 3'-O-succinate triethylammonium salt**C<sub>35</sub>H<sub>34</sub>FN<sub>2</sub>O<sub>10</sub>·C<sub>6</sub>H<sub>16</sub>N 763.87

ND09138

25mg	\$136.50
50mg	\$210.00
100mg	\$315.00

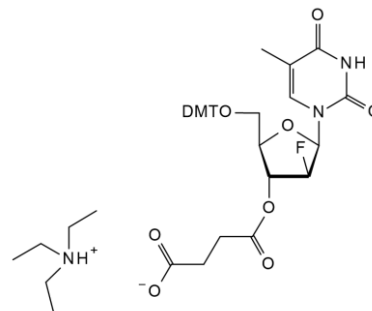
**1-(2'-Deoxy-5'-O-DMT-2'-fluoro-b-D-arabinofuranosyl)thymine**C<sub>31</sub>H<sub>31</sub>FN<sub>2</sub>O<sub>7</sub> 562.6

ND09137

10mg	\$63.00
25mg	\$94.50
50mg	\$157.50

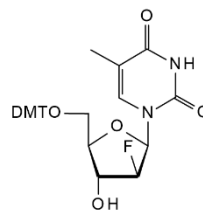
**1-(2'-Deoxy-5'-O-DMT-2'-fluoro-b-D-arabinofuranosyl)uracil**C<sub>30</sub>H<sub>29</sub>FN<sub>2</sub>O<sub>7</sub> 548.56

ND09139

10mg	\$57.80
25mg	\$94.50
50mg	\$157.50

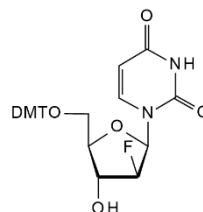

**2'-Deoxy-5'-O-DMT-2'-fluorocytidine**[177086-37-2] C<sub>30</sub>H<sub>30</sub>FN<sub>3</sub>O<sub>6</sub> 547.59

ND06060

10mg	\$63.00
25mg	\$94.50
50mg	\$157.50

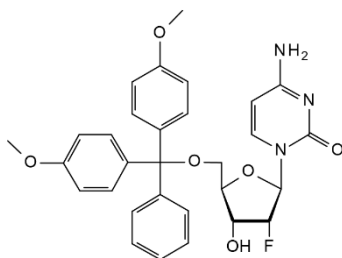
**2'-Deoxy-5'-O-DMT-2'-fluoroinosine 3'-CE phosphoramidite**

ND143429

Price On Application

**2'-Deoxy-5'-O-DMT-2'-fluoro-N2-isobutylguanosine 3'-O-succinate triethylammonium salt**C<sub>39</sub>H<sub>40</sub>FN<sub>5</sub>O<sub>10</sub>·C<sub>6</sub>H<sub>16</sub>N 859.98

ND08542

50mg	\$157.50
100mg	\$263.00
250mg	\$420.00

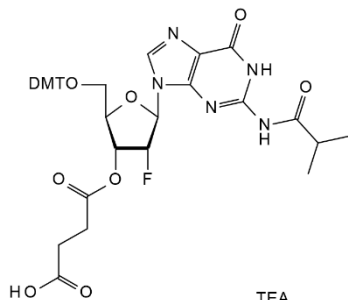
**2'-Deoxy-5'-O-DMT-2'-fluoro-N2-isobutylguanosine**

• N2-iBu-DMT-2'-F-dG

C<sub>35</sub>H<sub>36</sub>FN<sub>5</sub>O<sub>7</sub> 657.7

ND08524

50mg	\$50.00
100mg	\$65.00
250mg	\$85.00

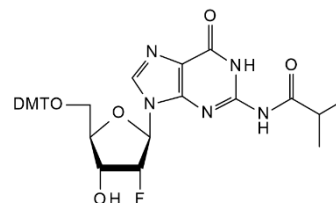
**2'-Deoxy-5'-O-DMT-2'-fluoro-5-methyluridine**C<sub>31</sub>H<sub>31</sub>N<sub>2</sub>O<sub>7</sub> 543.59

ND09140

50mg	\$75.00
100mg	\$125.00
250mg	\$195.00

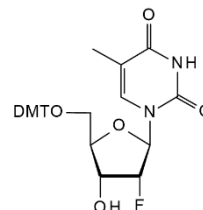
**2'-Deoxy-5'-O-DMT-2'-fluorouridine 3'-O-succinate triethylammonium salt**C<sub>34</sub>H<sub>32</sub>FN<sub>2</sub>O<sub>10</sub>·C<sub>6</sub>H<sub>16</sub>N 749.84

ND10842

50mg	\$63.00
100mg	\$105.00
250mg	\$172.50

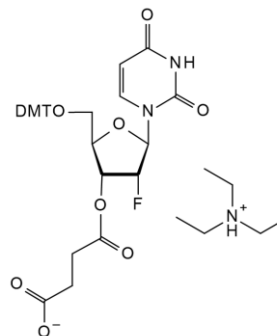

**DeoxyDMTfluo****2'-Deoxy-5'-O-DMT-2'-fluoro-L-uridine**C<sub>30</sub>H<sub>29</sub>FN<sub>2</sub>O<sub>7</sub> 548.57

ND02632

Price On Application

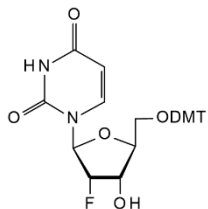
**2'-Deoxy-5'-O-DMT-2'-fluorouridine**

- 5'-O-DMT-2'-fluoro-2'-deoxy-D-uridine
- 2'-Fluoro-5'-O-DMT-uridine

[146954-74-7] C<sub>30</sub>H<sub>29</sub>FN<sub>2</sub>O<sub>7</sub> 548.57

ND06064

1g	\$50.00
2g	\$75.00
5g	\$112.00

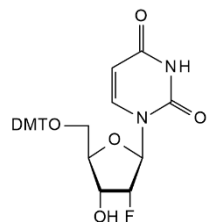
**2'-Deoxy-5'-O-DMT-5-fluorouridine**C<sub>30</sub>H<sub>29</sub>FN<sub>2</sub>O<sub>7</sub> 548.57

ND08228

25mg	\$89.50
50mg	\$168.00
100mg	\$263.00

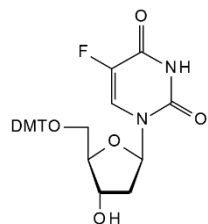
**2'-Deoxy-5'-O-DMT-guanosine-(DMF)-3'-Q Linker CPG; 1000 Å**

ND11621

1g \$157.50

**2'-Deoxy-5'-O-DMT-guanosine-(DMF)-succinyl-CPG 500 Å**

ND11628

250mg	\$65.00
500mg	\$100.00
1g	\$157.50

**2'-Deoxy-5'-O-DMT-guanosine-(DMF)-succinyl CPG 1000 Å**

ND11620

1g	\$262.50
5g	\$420.00
10g	\$735.00

**2'-Deoxy-5'-O-DMT-guanosine-(iBu)-3'-succinyl CPG 2000 Å**

ND11624

1g	\$157.50
5g	\$472.50
10g	\$840.00

**2'-Deoxy-5'-O-DMT-guanosine-(iBu)-succinyl CPG 1400 Å**

ND11615

250mg	\$60.00
500mg	\$100.00
1g	\$126.00



**2'-Deoxy-5'-O-DMT-guanosine-3'-O-P(OMe)N(iPr)<sub>2</sub>**• DMT-5'-O-dG-3'-O-P(OMe)N(iPr)<sub>2</sub>

ND02666

Price On Application

**2'-Deoxy-3'-O-DMT-N2-iBu-guanosine--succinyl-CPG 1000 Å**

ND11609

1g \$157.50

**2'-Deoxy-5'-O-DMT-N2-iBu-guanosine-3'-succinyl CPG 500 Å**

ND11605

1g	\$126.00
5g	\$367.50
10g	\$630.00

**2'-Deoxy-5'-O-DMT-inosine 3'-succinyl CPG 1000Å**

ND11633

50mg	\$90.00
100mg	\$150.00
250mg	\$237.50

**2'-Deoxy-5'-O-DMT-inosine 3'-succinyl CPG**

ND11631

50mg	\$85.00
100mg	\$130.00
250mg	\$237.50

**2'-Deoxy-5'-O-DMT-inosine**[93778-57-5] C<sub>31</sub>H<sub>50</sub>N<sub>4</sub>O<sub>8</sub> 554.61

ND08417

1g	\$75.00
2g	\$120.00
5g	\$225.00

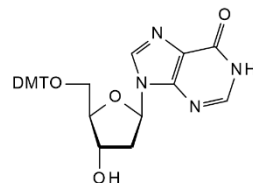
**2'-Deoxy-5'-O-DMT-5-iodouridine**[104375-88-4] C<sub>30</sub>H<sub>29</sub>N<sub>2</sub>O<sub>7</sub> 656.48

ND08238

250mg	\$70.00
500mg	\$100.00
1g	\$165.00

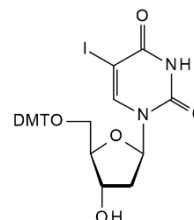
**2'-Deoxy-5'-O-DMT-N6-isobutyryladosine**C<sub>35</sub>H<sub>37</sub>N<sub>5</sub>O<sub>6</sub> 623.72

ND08598

100mg	\$53.00
250mg	\$80.00
500mg	\$135.00

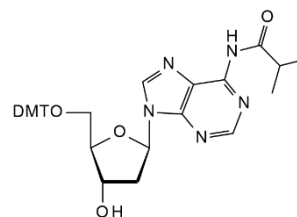

## DeoxyDMTisob

**2'-Deoxy-5'-O-DMT-N4-isobutyrylcytidine**

• N4-Isobutyryl-2'-deoxy-5'-O-DMT-cytidine

[100898-62-2] C<sub>38</sub>H<sub>37</sub>N<sub>5</sub>O<sub>7</sub> 599.69

ND02997	500mg	\$70.00
	1g	\$94.50
	2g	\$157.50

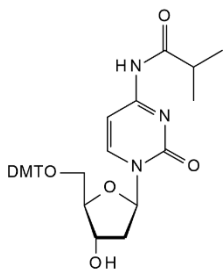
**2'-Deoxy-3'-O-DMT-N2-Isobutyrylguanosine**[140712-81-8] C<sub>35</sub>H<sub>37</sub>N<sub>5</sub>O<sub>7</sub> 639.71

ND06928	250mg	\$262.50
	500mg	\$395.00
	1g	\$682.50

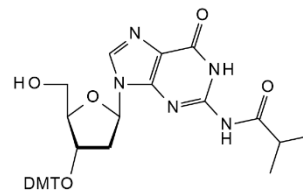
**2'-Deoxy-5'-O-DMT-N2-isobutyryl-a-guanosine**C<sub>35</sub>H<sub>37</sub>N<sub>5</sub>O<sub>7</sub> 639.71

ND08416	5mg	\$157.50
	10mg	\$262.50
	25mg	\$210.00

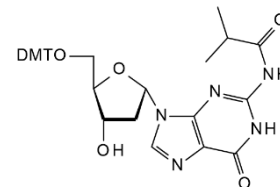
**2'-Deoxy-5'-O-DMT-N2-isobutyrylguanosine 3'-O-succinate**[74405-46-2] C<sub>39</sub>H<sub>41</sub>N<sub>5</sub>O<sub>10</sub> 739.77

ND09157	250mg	\$80.00
	500mg	\$135.00
	1g	\$204.80

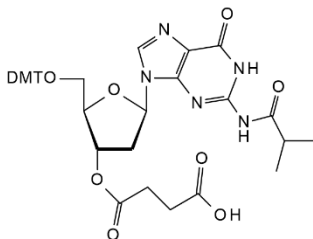
**2'-Deoxy-5'-O-DMT-N2-isobutyrylguanosine**

• N2-Isobutyryl-2'-deoxy-5'-O-DMT-D-guanosine

[68892-41-1] C<sub>35</sub>H<sub>37</sub>N<sub>5</sub>O<sub>7</sub> 639.71

ND02998	5g	\$80.00
	10g	\$140.00
	25g	\$265.00

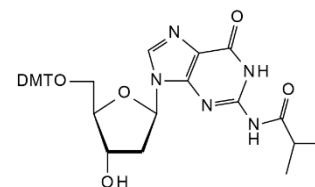
**2'-Deoxy-3'-O-DMT-N2-isobutyrylguanosine 5'-thiophosphoramidite**

• 2'-Deoxy-5'-dimethoxytrityl-N-isobutyryl-guanosine-3'-[(B-thiobenzoyl-ethyl)-(1-pyrrolidyl)]-thiophosphoramidite

C<sub>48</sub>H<sub>53</sub>N<sub>6</sub>O<sub>8</sub>PS<sub>2</sub> 937.08

ND46056	250mg	\$475.00
---------	-------	----------



**2'-Deoxy-5'-O-DMT-N2-isobutryl-3'-xanthylguanosine**C<sub>46</sub>H<sub>49</sub>N<sub>5</sub>O<sub>8</sub>S 832

ND08398

50mg	\$189.00
100mg	\$315.00
250mg	\$525.00

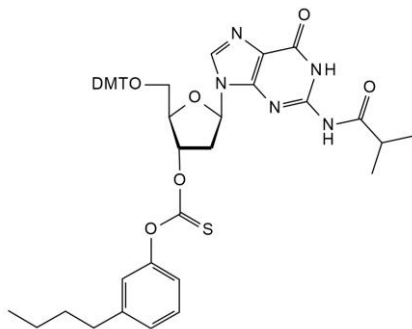
**1-(2'-Deoxy-5'-O-DMT-b-D-lyxofuranosyl)thymine**[112501-53-8] C<sub>31</sub>H<sub>32</sub>N<sub>2</sub>O<sub>7</sub> 544.6

ND10367

Price On Application

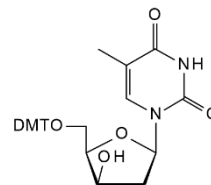

Refs: Eisenhut M, et al, Nucl. Med. Biol, 2002, 29, p263

**2'-Deoxy-5'-O-DMT-N6-methyladenosine**[98056-69-0] C<sub>32</sub>H<sub>33</sub>N<sub>5</sub>O<sub>5</sub> 567.64

ND09159

250mg	\$70.00
500mg	\$115.00
1g	\$175.00

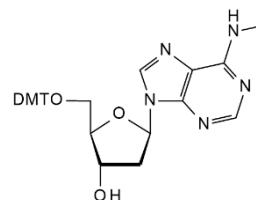
**2'-Deoxy-5'-O-DMT-N2-isopropylguanosine**[863910-15-0] C<sub>34</sub>H<sub>37</sub>N<sub>5</sub>O<sub>6</sub> 611.7

ND09158

250mg	\$80.00
500mg	\$135.00
1g	\$210.00

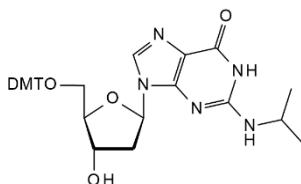
**2'-Deoxy-5'-O-DMT-5-methylcytidine**

• 5-Methyl-5'-O-DMT-deoxycytidine

C<sub>31</sub>H<sub>33</sub>N<sub>3</sub>O<sub>6</sub> 543.63

ND08559

100mg	\$158.00
250mg	\$262.50
500mg	\$475.00

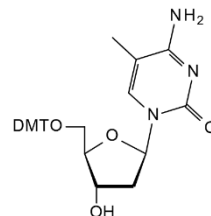
**2'-Deoxy-5'-O-DMT-N2-(4-isopropylphenoxyacetyl)guanosine**

• 5'-O-[Bis(4-methoxyphenyl)phenylmethyl]-2'-deoxy-N-[2-[4-(1-methylethyl)phenoxy]acetyl]guanosine

[909415-65-2] C<sub>42</sub>H<sub>43</sub>N<sub>5</sub>O<sub>8</sub> 745.82

ND156947

5g	\$650.00
10g	\$1050.00
25g	\$2125.00



## DeoxyDMTmeth

## 3'-Deoxy-5'-O-DMT-3'-C-methyluridine

ND15621

Price On Application



## 1-(2'-Deoxy-5'-O-DMT-3'-O-nitrophenylsulphonyl-b-D-lyxofuranosyl)thymine

• 1-5-[5-O-(4,4'-Dimethoxytrityl)-3-O-nitrophenylsulphonyl-2-deoxy-b-D-lyxofuranosyl]thymine

[444717-20-8] C<sub>37</sub>H<sub>35</sub>N<sub>3</sub>O<sub>11</sub>S 729.75

ND10366

10mg	\$100.00
30mg	\$255.00
40mg	\$320.00

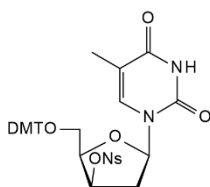

Refs: Oh SJ, et.al, Nucl. Med. Biol, 2003, 30, p151



## 2'-Deoxy-3'-O-DMT-5'-O-phenoxyacetyladenosine

• 5'-(2-Phenoxyacetate)-2'-deoxy-3'-O-[bis(4-methoxyphenyl)phenylmethyl]adenosine

[115388-94-8] C<sub>39</sub>H<sub>37</sub>N<sub>5</sub>O<sub>7</sub> 687.74

ND144749

Price On Application



## 2'-Deoxy-5'-O-DMT-N6-phenoxyacetyladenosine

• 5'-O-[Bis(4-methoxyphenyl)phenylmethyl]-2'-deoxy-N-(2-phenoxyacetyl)adenosine

[110522-82-2] C<sub>39</sub>H<sub>37</sub>N<sub>5</sub>O<sub>7</sub> 687.76

ND08050

1g	\$95.00
2g	\$180.00
5g	\$425.00

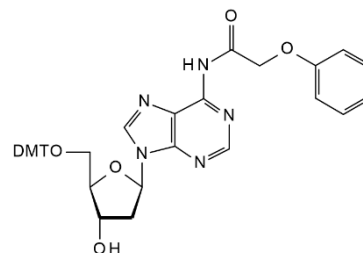

## 2'-Deoxy-5'-O-DMT-5-propargyloxyuridine

C<sub>33</sub>H<sub>32</sub>N<sub>2</sub>O<sub>8</sub> 584.63

ND08233

25mg	\$89.50
50mg	\$157.50
100mg	\$263.00

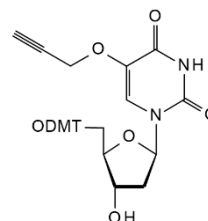

## 6-(2-Deoxy-5-O-DMT-b-D-ribofuranosyl)-3,4-dihydro-8H-pyrimido-[4,5-c][1,2]oxazin-7-one

[126128-43-6] C<sub>32</sub>H<sub>35</sub>N<sub>3</sub>O<sub>7</sub> 573.64

ND145589

25mg	\$90.00
50mg	\$150.00



D



**2-Deoxy-1-(5'-O-DMT-b-D-ribofuranosyl)-5-nitroindole**[869355-18-0] C<sub>34</sub>H<sub>32</sub>N<sub>2</sub>O<sub>7</sub> 580.63

ND11336

25mg	\$89.50
50mg	\$157.50
100mg	\$263.00

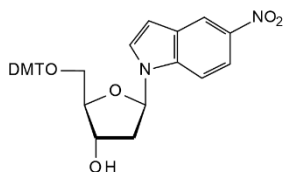
**2'-Deoxy-5'-O-DMT-2'-trifluoroacetamidouridine**C<sub>22</sub>H<sub>30</sub>F<sub>3</sub>N<sub>3</sub>O<sub>8</sub> 641.61

ND08249

Price On Application

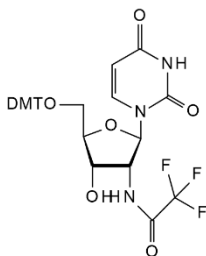
**2'-Deoxy-5'-O-DMT-uridine 3'-succinyl CPG 1000Å**

ND11635

50mg	\$85.00
100mg	\$150.00
250mg	\$237.50

**2'-Deoxy-5'-O-DMT-uridine succinyl 3'-CPG**

ND11634

100mg	\$150.00
250mg	\$237.50
500mg	\$370.00

**2'-Deoxy-5'-O-DMT-uridine**

- 5'-O-DMT-dU
- 5'-O-(4,4'-Dimethoxytrityl)-2'-deoxyuridine

[23669-79-6] C<sub>30</sub>H<sub>30</sub>N<sub>2</sub>O<sub>7</sub> 530.58

ND05965

100mg	\$50.00
250mg	\$80.00
500mg	\$130.00

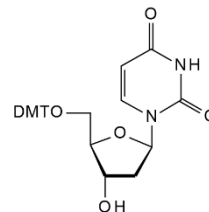
**9-(2'-Deoxy-5'-O-DMT-b-D-xylofuranosyl)adenine**

ND145598

Price On Application

**1-(2'-Deoxy-5'-O-DMT-b-D-xylofuranosyl)cytosine**

ND145595

Price On Application

**9-(2-Deoxy-b-L-erythro-pentofuranosyl)adenine**

see 2'-Deoxy-L-adenosine, ND04246 on page 173

**1-(2-Deoxy-b-L-erythro-pentofuranosyl)cytosine**

see 2'-Deoxy-L-cytidine, ND05747 on page 177

**9-(2-Deoxy-b-D-erythro-pentofuranosyl)guanine monohydrate**

see 2'-Deoxyguanosine monohydrate, ND06306 on page 205

**9-(2-deoxy-b-L-erythro-pentofuranosyl)guanine**

see 2'-Deoxy-L-guanosine, ND05774 on page 207

## Deoxyerythro

**1-(2-Deoxy-b-D-erythro-pentofuranosyl)-1H-imidazo[2,1-b]purin-4(5H)-one**

see 2'-Deoxy-N2,3-ethenoguanosine, ND16718 on page 190

**8-(2-Deoxy-b-D-erythro-pentofuranosyl)-imidazo[1,2-a]-1,3,5-triazine-2,4(3H,8H)-dione**

see 8-(2-Deoxy-b-D-ribofuranosyl)-imidazo[1,2-a]-1,3,5-triazine-2,4(3H,8H)-dione, ND145594 on page 220

**1-(2-Deoxy-b-L-erythro-pentofuranosyl)-5-iodo-2,4(1H,3H)-pyrimidinedione**

see ent-Idoxuridine, NE16541 on page 267

**7-(2-Deoxy-b-D-erythro-pentofuranosyl)-7H-pyrrolo[2,3-d]pyrimidin-4-amine**

see 7-Deaza-2'-deoxyadenosine, ND02936 on page 165

**1-(2-deoxy-b-L-erythro-pentofuranosyl)thymine**

see L-Thymidine, NT02679 on page 365

**1-(2-Deoxy-b-L-erythro-pentofuranosyl)uracil**

see 2'-Deoxy-L-uridine, ND06307 on page 225

**2'-Deoxy-N2,3-ethenoguanosine**

• 1-(2-Deoxy-b-D-erythro-pentofuranosyl)-1H-imidazo[2,1-b]purin-4(5H)-one

[121055-53-6] C<sub>12</sub>H<sub>13</sub>N<sub>5</sub>O<sub>4</sub> 291.26

ND16718

2mg	\$950.00
5mg	\$1750.00
10mg	\$2500.00

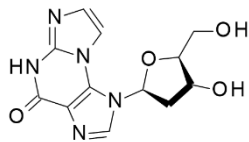

Refs: Schlatter, J, et al, Food Chem. Toxicol, 28, 205

**1-Deoxy-N-ethyl-1-[6-[(phenylmethyl)amino]-9H-purin-9-yl]-b-D-ribofuranuronamide**

see N6-Benzyl-5'-ethylcarboxamidoadenosine, NB06327 on page 116

**2'-Deoxy-5-ethyluridine**

• Edoxudine

[15176-29-1] C<sub>11</sub>H<sub>16</sub>N<sub>2</sub>O<sub>5</sub> 256.26

ND08006

100mg	\$90.00
250mg	\$157.50
500mg	\$265.00

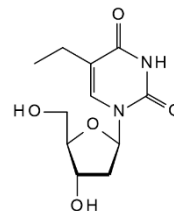
**2'-Deoxy-4'-ethynyl-2-fluoroadenosine**

• EFdA

ND45638

Price On Application

**2'-Deoxy-5-ethynyluridine**

see 5-Ethynyl-2'-deoxyuridine, NE08701 on page 272

**2'-Deoxy-8-(9H-fluoren-2-ylamino)-guanosine**[73051-69-1] C<sub>23</sub>H<sub>22</sub>N<sub>6</sub>O<sub>4</sub> 446.46

ND10433

1mg	\$92.00
2mg	\$168.00
5mg	\$365.00

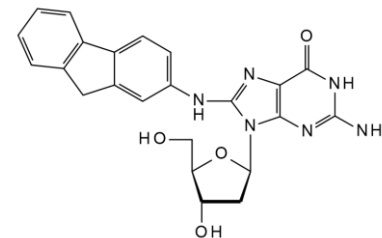

**9-(2-Deoxy-2-fluoro-a-D-arabinofuranosyl)-9H-purin-6-amine**[20187-82-0] C<sub>10</sub>H<sub>12</sub>FN<sub>5</sub>O<sub>3</sub> 269.23

ND144479

Price On Application

**2'-Deoxy-2'-fluoroadenosine-5'-diphosphate**[68357-16-4] C<sub>10</sub>H<sub>14</sub>FN<sub>5</sub>O<sub>8</sub>P<sub>2</sub> 429.19

ND86951

Price On Application

**2'-Deoxy-2'-fluoroadenosine-5'-monophosphate**

• 2'-Deoxy-2'-fluoro-5'-adenylic acid

[68245-91-0] C<sub>10</sub>H<sub>13</sub>FN<sub>5</sub>O<sub>6</sub>P 349.21

ND145452

Price On Application

**2'-Deoxy-2'-fluoroadenosine-5'-triphosphate lithium salt - 100mM aqueous solution**

• 2'-F-dATP.Li

[73449-07-7 (free acid)] C<sub>10</sub>H<sub>11</sub>FN<sub>5</sub>O<sub>12</sub>P<sub>3</sub>.4Li 532.9

ND46151

1mg	\$95.00
2.5mg	\$187.50
5mg	\$325.00

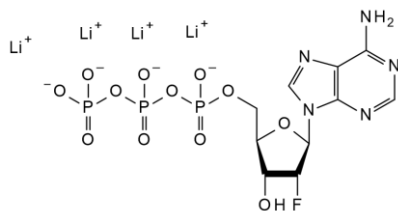
**2'-Deoxy-2'-fluoroadenosine-5'-triphosphate sodium salt - 100mM aqueous solution**

• 2'-FdATP.Na

C<sub>10</sub>H<sub>15</sub>FN<sub>5</sub>O<sub>12</sub>P<sub>3</sub>.xNa 453.15 (free acid basis)

ND13493

2.5mg	\$150.00
5mg	\$250.00
10mg	\$390.00

**2'-Deoxy-2'-fluoroadenosine-5'-triphosphate tetralithium salt**

• 2'-Fluoro-2'-deoxy-ATP.4Li

[73449-07-7 (free acid)] C<sub>10</sub>H<sub>11</sub>FN<sub>5</sub>O<sub>12</sub>P<sub>3</sub>.4Li 532.9

ND15214

1mg	\$65.00
2mg	\$110.00
5mg	\$225.00

**2'-Deoxy-2'-fluoroadenosine-5'-triphosphate**

• 2'-FdATP

[73449-07-7] C<sub>10</sub>H<sub>15</sub>FN<sub>5</sub>O<sub>12</sub>P<sub>3</sub> 509.18

ND09532

Price On Application

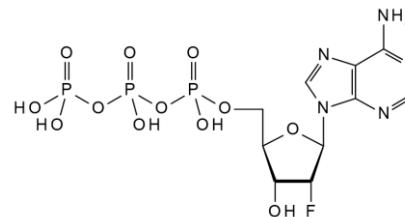

**Deoxyfluoroa****2'-Deoxy-2'-fluoroadenosine**

- 2'-Fluoro-2'-deoxy-D-adenosine
- 9-(2-Fluoro-2-deoxy-b-D-ribofuranosyl)-adenine

[64183-27-3] C<sub>10</sub>H<sub>12</sub>FN<sub>5</sub>O<sub>3</sub> 269.24

ND02827	250mg	\$80.00
	500mg	\$135.00
	1g	\$210.00

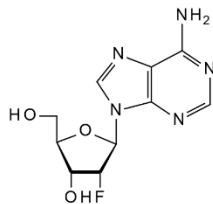

Refs: Olsen DB, Benseler F, Aurup H, Pieken WA, Eckstein F, Biochemistry 1991, Vol30, p9735-9741

**2'-Deoxy-2-fluoroadenosine**

- (9-(2-Deoxy-b-D-ribofuranosyl)-2-fluoroadenine

[21679-12-9] C<sub>10</sub>H<sub>12</sub>FN<sub>5</sub>O<sub>3</sub> 269.23

ND29528	250mg	\$135.00
	500mg	\$195.00
	1g	\$345.00

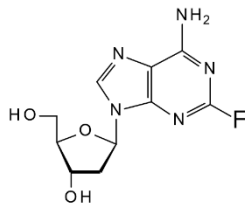
**2'-Deoxy-5-fluoroadenosine**

ND02602

Price On Application

**3'-Deoxy-2-fluoroadenosine**

- 2-Fluoro-cordycepin

[15386-69-3] C<sub>10</sub>H<sub>12</sub>FN<sub>5</sub>O<sub>3</sub> 269.23

ND29524

Price On Application

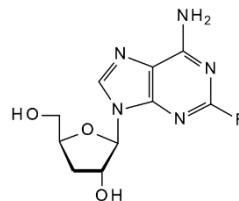
**3'-Deoxy-3'-fluoroadenosine**

- 3'-Fluoroadenosine

[75059-22-2] C<sub>10</sub>H<sub>12</sub>FN<sub>5</sub>O<sub>3</sub> 269.23

ND15616

1mg	\$85.00
2mg	\$150.00
5mg	\$300.00

**2'-Deoxy-2'-fluoro-5'-adenylic acid**

see 2'-Deoxy-2'-fluoroadenosine-5'-monophosphate, ND145452 on page 191

**9-(2'-Deoxy-2'-fluoro-b-D-arabinofuranosyl)adenine**

- 2'-FANA-A
- 6-Aminopurine-2'-fluoro-2'-deoxyarabinofuranoside

[20227-41-2] C<sub>10</sub>H<sub>12</sub>FN<sub>5</sub>O<sub>3</sub> 269.24

ND09204

10mg	\$60.00
25mg	\$75.00
50mg	\$115.00

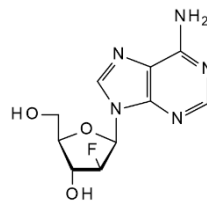

**2-Deoxy-2-Fluoro-a-D-arabinofuranosylamine**[149624-20-4] C<sub>5</sub>H<sub>10</sub>FNO<sub>3</sub> 151.14

ND89871

Price On Application

**2-Deoxy-2-fluoro-b-D-arabinofuranosylamine**[149624-26-0] C<sub>5</sub>H<sub>10</sub>FNO<sub>3</sub> 151.14

ND89208

Price On Application

**1-(2'-Deoxy-2'-fluoro-b-D-arabinofuranosyl)cytosine HCl**

- 2'-FANA-C.HCl
- 4-Amino-1-[(2R,3S,4R,5R)-3-fluoro-4-hydroxy-5-(hydroxymethyl)-oxolan-2-yl]pyrimidin-2-one.HCl

[56632-83-8] C<sub>9</sub>H<sub>12</sub>FN<sub>3</sub>O<sub>4</sub>.HCl 281.67

ND08343

50mg	\$85.00
100mg	\$135.00
250mg	\$225.00

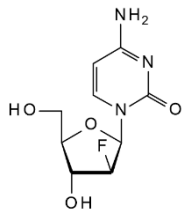
**1-(2'-Deoxy-2'-fluoro-b-D-arabinofuranosyl)-5-ethyluracil**C<sub>11</sub>H<sub>15</sub>FN<sub>2</sub>O<sub>5</sub> 274.25

ND05411

200mg	\$74.00
500mg	\$160.00
1g	\$262.50

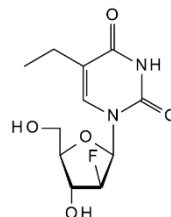
**9-(2'-Deoxy-2'-fluoro-b-D-arabinofuranosyl)guanine**

• 2'-FANA-G

[103884-98-6] C<sub>10</sub>H<sub>12</sub>FN<sub>5</sub>O<sub>4</sub> 285.24

ND08478

10mg	\$40.00
25mg	\$68.50
50mg	\$110.50

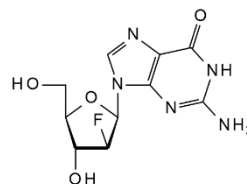
**9-(2'-Deoxy-2'-fluoro-b-D-arabinofuranosyl)hypoxanthine**

• 2'-FANA-I

C<sub>10</sub>H<sub>11</sub>FN<sub>4</sub>O<sub>4</sub> 270.22

ND09525

50mg	\$95.00
100mg	\$175.00
250mg	\$315.00

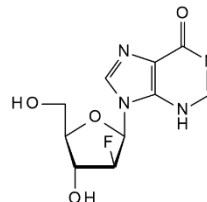

## Deoxyfluoroa

## 1-(2'-Deoxy-2'-fluoro-b-D-arabinofuranosyl)-5-iodouracil

• Fialuridine

[69123-98-4] C<sub>9</sub>H<sub>10</sub>FIN<sub>2</sub>O<sub>5</sub> 372.09

ND08477

25mg	\$85.00
50mg	\$150.00
100mg	\$260.00

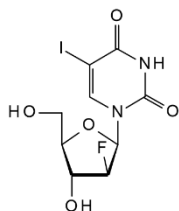

## 1-(2'-Deoxy-2'-fluoro-b-L-arabinofuranosyl)-5-methyluracil

see *Clevudine, NC09470* on page 153

## 1-(2-Deoxy-2-fluoro-b-D-arabinofuranosyl)-5-methyluracil

• D-FMAU

[69256-17-3] C<sub>10</sub>H<sub>13</sub>FN<sub>2</sub>O<sub>5</sub> 260.22

ND11876

10mg	\$85.00
25mg	\$165.00
50mg	\$300.00

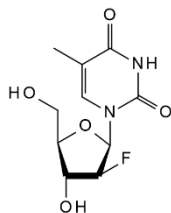

## 1-(5'-Deoxy-5'-fluoro-b-D-arabinofuranosyl)-2-nitroimidazole

[220793-03-3] C<sub>8</sub>H<sub>10</sub>FN<sub>3</sub>O<sub>5</sub> 247.18

ND07902

5mg	\$725.00
10mg	\$1000.00
25mg	\$2250.00

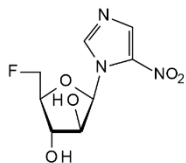

Refs: Piet M, et.al, J. Nucl. Med, 2005, 46, p106

## 1-(2'-Deoxy-2'-fluoro-a-L-arabinofuranosyl)-thymine

[1027764-72-2] C<sub>10</sub>H<sub>13</sub>FN<sub>2</sub>O<sub>5</sub> 260.22

ND58417

25mg	\$64.50
50mg	\$103.00
100mg	\$165.00

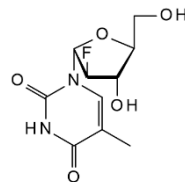

## 1-(2'-Deoxy-2'-fluoro-b-D-arabinofuranosyl)uracil 5'-triphosphate triethylammonium salt

C<sub>9</sub>H<sub>13</sub>FN<sub>2</sub>O<sub>14</sub>P<sub>3</sub>·C<sub>6</sub>H<sub>16</sub>N 587.32

ND11257

Price On Application

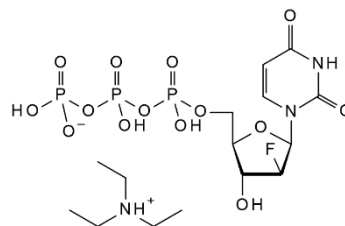

## 1-(2'-Deoxy-2'-fluoro-b-D-arabinofuranosyl)uracil

- 1-(2-Deoxy-2-fluoro-b-D-arabinofuranosyl)uracil
- 2-Deoxy-2'-fluoro-D-arabinofuranosyl uracil
- 2'-Fluoro-arabinofuranosyl-2'-deoxy-uridine

[69123-94-0] C<sub>9</sub>H<sub>11</sub>FN<sub>2</sub>O<sub>5</sub> 246.2

ND06062

1g	\$85.00
2g	\$160.00
5g	\$375.00

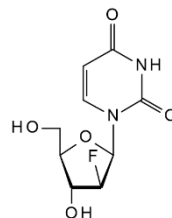

Refs: Strezycski RZ, et.al, J. Med. Chem, 1990, 33, p2150

**1-(2'-Deoxy-2'-fluoro-b-L-arabinofuranosyl)-uracil**[69123-94-0] C<sub>9</sub>H<sub>11</sub>FN<sub>2</sub>O<sub>5</sub> 246.19

ND58418

500mg  
1g\$65.00  
\$106.68**1-(2'-Deoxy-2'-fluoro-b-D-arabinofuranosyl)uracil**

see 1-(2'-Deoxy-2'-fluoro-b-D-arabinofuranosyl)uracil, ND06062 on page 194

**2-Deoxy-2'-fluoro-D-arabinofuranosyl uracil**

see 1-(2'-Deoxy-2'-fluoro-b-D-arabinofuranosyl)uracil, ND06062 on page 194

**9-(2-Deoxy-2-fluoro-b-D-xylofuranosyl)-9H-purin-6-amine**[123334-75-8] C<sub>10</sub>H<sub>12</sub>FN<sub>5</sub>O<sub>3</sub> 269.23

ND157192

Price On Application

**2'-Deoxy-2'-fluorocytidine-5'-monophosphate**

• 2'-Deoxy-2'-fluoro-5'-cytidylic acid

[63541-62-8] C<sub>9</sub>H<sub>13</sub>FN<sub>3</sub>O<sub>7</sub>P 325.19

ND145453

Price On Application

**2'-Deoxy-2'-fluorocytidine-5'-triphosphate lithium salt - 100mM aqueous solution**[66840-03-7 (free acid)] C<sub>9</sub>H<sub>11</sub>FN<sub>3</sub>O<sub>13</sub>P<sub>3</sub>·Li<sub>4</sub> 508.88

NF46155

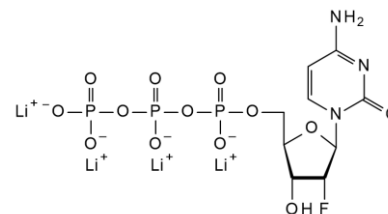
1mg  
2.5mg  
5mg\$95.00  
\$187.50  
\$325.00**2'-Deoxy-2'-fluorocytidine-5'-triphosphate sodium salt - 100mM aqueous solution**

• 2'F-dCTP.Na

C<sub>9</sub>H<sub>15</sub>FN<sub>3</sub>O<sub>13</sub>P<sub>3</sub> 485.15

ND157276

2.5mg  
5mg  
10mg\$150.00  
\$250.00  
\$390.00**2'-Deoxy-2'-fluorocytidine-5'-triphosphate tetralithium salt**

• 2'F-fluoro-dCTP

C<sub>9</sub>H<sub>11</sub>FLi<sub>4</sub>N<sub>3</sub>O<sub>13</sub>P<sub>3</sub> 508.88

ND09530

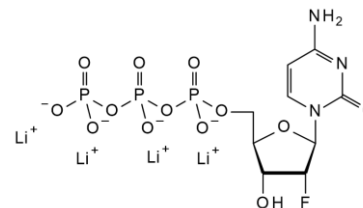
1mg  
2mg  
5mg\$65.00  
\$110.00  
\$225.00

**Deoxyfluoroc****2'-Deoxy-2'-fluorocytidine**[10212-20-1] C<sub>9</sub>H<sub>12</sub>FN<sub>3</sub>O<sub>4</sub> 245.21

ND06189

1g	\$42.00
2g	\$66.00
5g	\$135.00

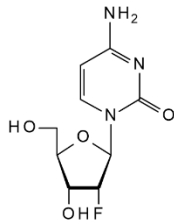

Refs: Stuyver LJ, McBrayer TR, Whitaker T, Tharnish PM, Ramesh M, Lostia S, Cartee L, Shi J, Hobbs A, Schinazi RF, Antimicrob. Agents Chemother. 2004, Vol48, Pt2, p651-654

**2'-Deoxy-5-fluorocytidine**[10356-76-0] C<sub>9</sub>H<sub>12</sub>FN<sub>3</sub>O<sub>4</sub> 245.21

ND10199

100mg	\$55.00
250mg	\$82.50
500mg	\$130.00

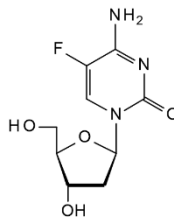
**3'-Deoxy-3'-fluorocytidine**

[123402-20-0]

ND15613

Price On Application

**5'-Deoxy-5-fluorocytidine**

• 1-(5-Deoxy-b-D-ribofuranosyl)-5-fluorocytidine

[66335-38-4] C<sub>9</sub>H<sub>12</sub>FN<sub>3</sub>O<sub>4</sub> 245.21

ND04700

100mg	\$84.00
250mg	\$132.50
500mg	\$210.00

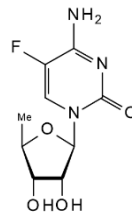

Refs: Cook AF, Holman MJ, Kramer MJ, Trown PW, J. Med. Chem. 1979, Vol22, No11, p1330

**2'-Deoxy-2'-fluoro-5'-cytidylic acid**

see 2'-Deoxy-2'-fluorocytidine-5'-monophosphate, ND145453 on page 195

**2'-Deoxy-2'-fluoro-diaminopurine riboside**

see 2-Amino-2'-deoxy-2'-fluoroadenosine, NA05649 on page 46

**1-(2'-deoxy-2'-fluoro-3',5'-di-O-benzoyl-b-L-arabinofuranosyl)-uracil**[1312300-53-0] C<sub>23</sub>H<sub>19</sub>FN<sub>2</sub>O<sub>7</sub> 454.4

ND58415

50mg	\$90.50
100mg	\$145.00
250mg	\$330.00

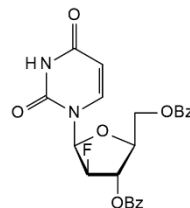
**9-(2,3-Deoxy-3-fluoro-b-D-erythro-pentofuranosyl)guanine**

see 2',3'-Dideoxy-3'-fluoroguanosine, ND06059 on page 242

**2'-Deoxy-2'-fluoro-2-fluoroadenosine**

see 9-(2'-Deoxy-2'-fluoro-b-D-ribofuranosyl)-2-fluoroadenine, ND09526 on page 201



**2'-Deoxy-2'-fluoroguanosine-5'-monophosphate**

• 2'-Deoxy-2'-fluoro-5'-guanylic acid

[170784-58-4] C<sub>10</sub>H<sub>13</sub>FN<sub>5</sub>O<sub>7</sub>P 365.21

ND145454

Price On Application

**2'-Deoxy-2'-fluoroguanosine-5'-triphosphate lithium salt - 100mM aqueous solution**[202186-97-8] C<sub>10</sub>H<sub>11</sub>FN<sub>5</sub>O<sub>13</sub>P<sub>3</sub>·4Li 548.9

ND46153

1mg	\$95.00
2.5mg	\$187.50
5mg	\$325.00

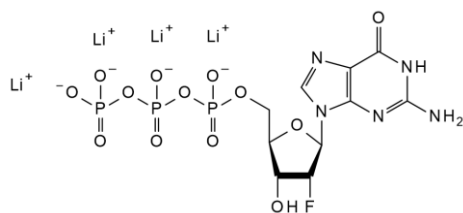
**2'-Deoxy-2'-fluoroguanosine-5'-triphosphate sodium salt - 100mM aqueous solution**

• 2'F-dGTP.Na

C<sub>10</sub>H<sub>15</sub>FN<sub>5</sub>O<sub>13</sub>P<sub>3</sub>·Na 548.16

ND157277

2.5mg	\$150.00
5mg	\$250.00
10mg	\$390.00

**2'-Deoxy-2'-fluoroguanosine-5'-triphosphate tetralithium salt**[202186-97-8] C<sub>10</sub>H<sub>15</sub>FN<sub>5</sub>O<sub>13</sub>P<sub>3</sub>·xLi 525.17 (free acid basis)

ND09529

1mg	\$95.00
2mg	\$140.00
5mg	\$275.00

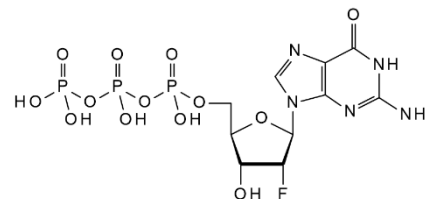
**2'-Deoxy-2'-fluoroguanosine**

- 2'-Fluoro-2'-deoxy-D-guanosine
- 9-(2-Fluoro-2-deoxy-b-D-ribofuranosyl)-2,6-diaminopurine
- 9-(2-Fluoro-2-deoxy-b-D-ribofuranosyl)-guanine

[78842-13-4][125291-17-0] C<sub>10</sub>H<sub>12</sub>FN<sub>5</sub>O<sub>4</sub> 285.23

ND02828

500mg	\$60.00
1g	\$95.00
2g	\$170.00

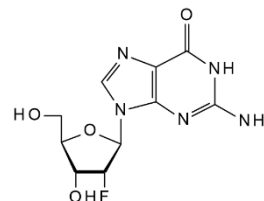

Refs: Benseler F, Williams DM, Eckstein F, Nucleosides &amp; Nucleotides 1992

**3'-Deoxy-3'-fluoroguanosine**

• 9-[3-Deoxy-3-fluoro-b-D-ribofuranosyl]guanine

[123402-21-1] C<sub>10</sub>H<sub>12</sub>N<sub>5</sub>O<sub>4</sub>F 285.23

ND10826

25mg	\$65.00
50mg	\$110.00
100mg	\$180.00

**2'-Deoxy-2'-fluoro-5'-guanylic acid**

see 2'-Deoxy-2'-fluoroguanosine-5'-monophosphate, ND145454 on page 197

**Deoxyfluoroi****2'-Deoxy-2'-fluorinosine 5'-monophosphate lithium salt**C<sub>10</sub>H<sub>12</sub>FN<sub>4</sub>O<sub>7</sub>P·xLi 350.20 (free acid basis)

ND76635

Price On Application

**2'-Deoxy-2'-fluorinosine**

- 2'-Fluoro-2'-deoxy-D-inosine
- 9-(2-Fluoro-2-deoxy-b-D-ribofuranosyl)-hypoxanthine

[80049-87-2] C<sub>10</sub>H<sub>11</sub>FN<sub>4</sub>O<sub>4</sub> 270.22

ND06005

100mg	\$65.00
250mg	\$125.00
500mg	\$195.00

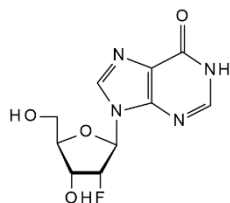
**3'-Deoxy-3'-fluorinosine**

[117517-20-1]

ND61411

Price On Application

**5'-Deoxy-5-fluoro-5-iodo-2',3'-O-isopropylidencytidine**[61787-05-1] C<sub>12</sub>H<sub>15</sub>FIN<sub>3</sub>O<sub>4</sub> 411.17

ND02642

25mg	\$105.00
50mg	\$199.50
100mg	\$389.00

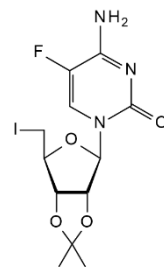
**2'-Deoxy-2'-fluoro-5-iodouridine**

- 5-Iodo-2'-fluorouridine

[183293-80-3][55612-21-0] C<sub>9</sub>H<sub>10</sub>FIN<sub>2</sub>O<sub>5</sub> 372.09

ND07901

25mg	\$60.00
50mg	\$95.00
100mg	\$175.00

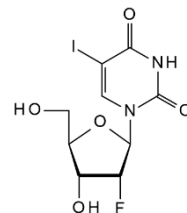

Refs: Conti PS, et.al, Nucl. Med. Biol, 1995, 22, p783

**2'-Deoxy-2'-fluoro-N2-isobutyrylguanosine**

- N2-Isobutyryl-2'-fluoro-deoxyguanosine

C<sub>14</sub>H<sub>18</sub>FN<sub>5</sub>O<sub>5</sub> 355.33

ND08523

50mg	\$50.00
100mg	\$75.00
250mg	\$125.00

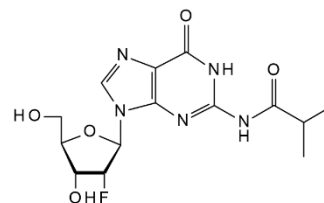
**2'-Deoxy-2'-fluoroisoguanosine**

see 9-(2'-Deoxy-2'-fluoro-b-D-ribofuranosyl)-isoguanine, ND09527 on page 201

D

**5'-Deoxy-5-fluoro-N4-(isopentylloxycarbonyl)cytidine**

see 5'-Deoxy-5-fluoro-N-[(3-methylbutoxy)carbonyl]cytidine, ND16527 on page 199

**5'-Deoxy-5-fluoro-2',3'-O-isopropylidene cytidine**[66335-39-5] C<sub>12</sub>H<sub>16</sub>FN<sub>3</sub>O<sub>4</sub> 285.28

ND06334

5g	\$99.80
10g	\$157.50
25g	\$315.00

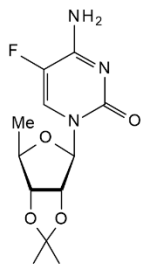
**2'-Deoxy-2'-fluoro-5-methylarabinofuranosyluracil**

see Clevudine, NC09470 on page 153

**5'-Deoxy-5-fluoro-N-[(2-methylbutoxy)carbonyl]cytidine**[910129-15-6] C<sub>15</sub>H<sub>22</sub>FN<sub>3</sub>O<sub>6</sub> 359.35

ND16526

1mg	\$149.90
2mg	\$272.60
5mg	\$495.50

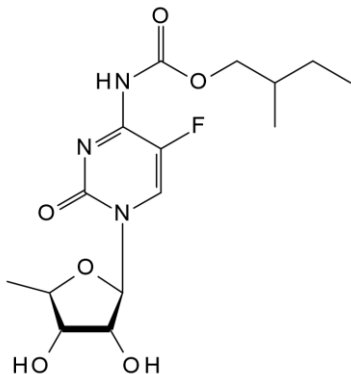
**5'-Deoxy-5-fluoro-N-[(3-methylbutoxy)carbonyl]cytidine**

- [1-(5-Deoxy-b-D-ribofuranosyl)-5-fluoro-1,2-dihydro-2-oxo-4-pyrimidinyl]-carbamic acid 3-methylbutyl ester
- 5'-Deoxy-5-fluoro-N4-(isopentylloxycarbonyl)cytidine

[162204-30-0] C<sub>15</sub>H<sub>22</sub>FN<sub>3</sub>O<sub>6</sub> 359.35

ND16527

2mg	\$125.00
5mg	\$227.20
10mg	\$413.00

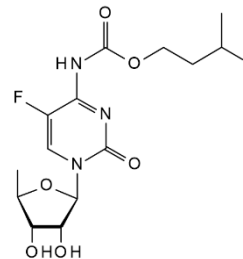
**2'-Deoxy-2'-fluoro-5-methylcytidine 5'-monophosphate**

ND145455

Price On Application

**2'-Deoxy-2'-fluoro-5-methylcytidine 5'-triphosphate**[847647-94-3] C<sub>10</sub>H<sub>17</sub>FN<sub>3</sub>O<sub>13</sub>P<sub>3</sub> 499.17

ND71635

Price On Application

**2'-Deoxy-2'-fluoro-5-methylcytidine**[182495-80-3] C<sub>10</sub>H<sub>14</sub>FN<sub>3</sub>O<sub>4</sub> 259.23

ND71638

5mg	\$78.00
10mg	\$120.00
25mg	\$235.00



**Deoxyfluorom****(E)-2'-Deoxy-2'-(fluoromethylene)cytidine**

• Tezacitabine

[130306-02-4] C<sub>10</sub>H<sub>12</sub>FN<sub>3</sub>O<sub>4</sub> 257.22

ND10202

100mg

\$7500.00

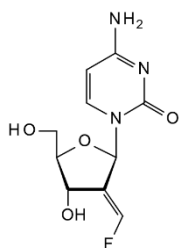
**3'-Deoxy-3'-fluoro-2'-C-methylguanosine**[1434144-21-4] C<sub>11</sub>H<sub>14</sub>FN<sub>5</sub>O<sub>4</sub> 299.26

ND63066

Price On Application

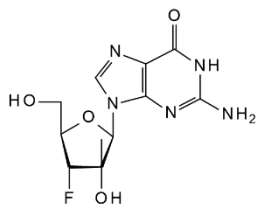
**2'-Deoxy-2'-fluoro-2'-C-methyl-5-methyluridine**

ND29434

Price On Application

**2'-Deoxy-2'-fluoro-2'-C-methyluridine 5'-triphosphate sodium salt**[1015073-42-3 (free acid)] C<sub>10</sub>H<sub>16</sub>FN<sub>2</sub>O<sub>14</sub>P<sub>3</sub> 500.16

ND63565

Price On Application

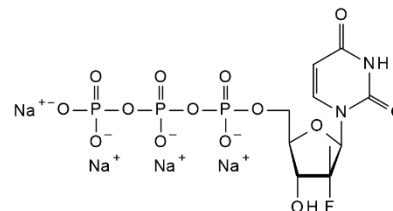
**2'-Deoxy-2'-fluoro-2'-C-methyluridine**

• PSI-6206

[863329-66-2] C<sub>10</sub>H<sub>13</sub>FN<sub>2</sub>O<sub>5</sub> 260.22

ND29433

50mg  
100mg  
250mg\$60.00  
\$95.00  
\$175.00**2'-Deoxy-2'-fluoro-5-methyluridine**• 2'-Deoxy-2'-fluoro-b-D-ribofuranosyl methyluracil  
• 2'-Deoxy-2'-fluorothymidine[2923-73-1][122799-38-6] C<sub>10</sub>H<sub>13</sub>FN<sub>2</sub>O<sub>5</sub> 260.22

ND03465

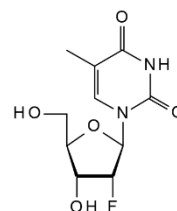
25mg  
50mg  
100mg\$70.00  
\$115.00  
\$190.00

**3'-Deoxy-5-fluoro-3'-methyluridine**

[37731-67-2]

ND144802

Price On Application

**1-(3'-Deoxy-3'-fluoro-b-D-pentofuranosyl)thymine**

see 3'-Deoxy-3'-fluorothymidine, ND02399 on page 202

**5'-Deoxy-5-fluoro-N-[(pentyloxy)carbonyl]cytidine cyclic 2',3'-carbonate**

see Capecitabine 2',3'-cyclic carbonate, NC16644 on page 135

**5'-Deoxy-5-fluoro-N4-(pentyloxy)carbonyl]cytidine**

- Capecitabine
- [1-(5-Deoxy-b-D-ribofuranosyl)-5-fluoro-1,2-dihydro-2-oxo-4-pyrimidinyl] carbamic acid penty ester

[154361-50-9] C<sub>15</sub>H<sub>22</sub>FN<sub>3</sub>O<sub>6</sub> 359.35

ND09160

1g	\$65.00
2g	\$110.00
5g	\$225.00

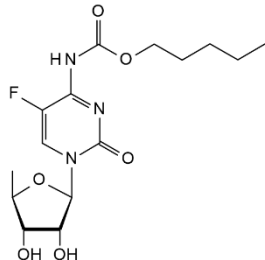

Refs: Xiangshu F, et.al, Nucl. Med. Biol, 2004, 31, p1033

**1-(2-Deoxy-2-fluoro-5-O-phosphono-b-D-arabinofuranosyl)-5-iodo-2,4(1H,3H)-pyrimidinedione**

see Fialuridine 5'-monophosphate, NF16547 on page 274

**9-[3-Deoxy-3-fluoro-b-D-ribofuranosyl]guanine**

see 3'-Deoxy-3'-fluoroguanosine, ND10826 on page 197

**9-(2'-Deoxy-2'-fluoro-b-D-ribofuranosyl)-2-fluoroadenine**

- 2'-Deoxy-2'-fluoro-2-fluoroadenosine

C<sub>10</sub>H<sub>11</sub>F<sub>2</sub>N<sub>5</sub>O<sub>3</sub> 287.23

ND09526

25mg	\$70.00
50mg	\$125.00
100mg	\$225.00

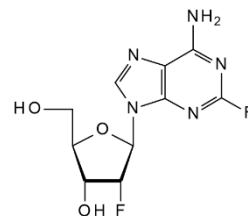
**9-(2'-Deoxy-2'-fluoro-b-D-ribofuranosyl)-isoguanine**

- 2'-Deoxy-2'-fluoroisoguanosine

C<sub>10</sub>H<sub>12</sub>FN<sub>5</sub>O<sub>4</sub> 285.24

ND09527

25mg	\$90.00
50mg	\$165.00
100mg	\$295.00

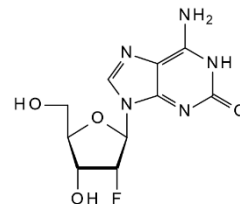
**2'-Deoxy-2'-fluoro-b-D-ribofuranosyl methyluracil**

see 2'-Deoxy-2'-fluoro-5-methyluridine, ND03465 on page 200

**1-(2-Deoxy-2-fluoro-b-L-ribofuranosyl) uracil**

see 2'-Deoxy-2'-fluoro-L-uridine, ND02886 on page 204

**3'-Deoxy-3'-fluorothymidine-5'-monophosphate disodium salt**

ND63287

Price On Application



**Deoxyfluorot****3'-Deoxy-3'-fluorothymidine-5'-triphosphate sodium salt**

ND63288

25mg

\$3000.00

**2'-Deoxy-2'-fluorothymidine**

see 2'-Deoxy-2'-fluoro-5-methyluridine, ND03465 on page 200

**3'-Deoxy-3'-fluorothymidine**

- 3'-Fluorothymidine
- 1-(3'-Deoxy-3'-fluoro-b-D-pentofuranosyl)thymine
- Alovudine

[25526-93-6]

C<sub>10</sub>H<sub>13</sub>FN<sub>2</sub>O<sub>4</sub>

244.22

ND02399

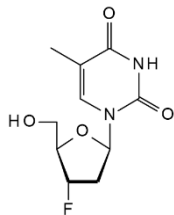
25mg  
50mg  
100mg\$45.00  
\$55.00  
\$85.00

Refs: Langen P, Etzold G, Hintsche R, Kowolik G, Acta Biol. Med. Ger. 1969, 23(6), 759-66; Eisenhut M, et.al, J. Labelled Compds. Radiopharm, 2000, 43, p1211

**5'-Deoxy-5'-fluorothymidine**

[17199-43-8]

C<sub>10</sub>H<sub>13</sub>FN<sub>2</sub>O<sub>4</sub>

244.22

ND78221

Price On Application

**3'-Deoxy-3'-fluoro-5'-O-toluylthymidine**C<sub>18</sub>H<sub>19</sub>FN<sub>2</sub>O<sub>5</sub> 348.43

ND08983

Price On Application

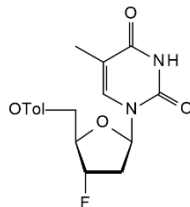
**2'-Deoxy-2'-fluoro-5-(trimethylstannyl)uridine-epimer**

- FTRU

[336881-26-6]

C<sub>12</sub>H<sub>19</sub>FN<sub>2</sub>O<sub>5</sub>Sn

408.98

ND03507

Price On Application

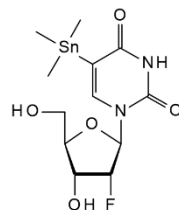

Refs: Vaidyanathan G, et.al, Nucl. Med. Biol, 1998, 25, p487

**1-(2'-Deoxy-2'-fluoro-5'-O-trityl-b-L-arabinofuranosyl)-uracil**C<sub>28</sub>H<sub>25</sub>FN<sub>2</sub>O<sub>5</sub>

488.51

ND58416

1g

\$95.41

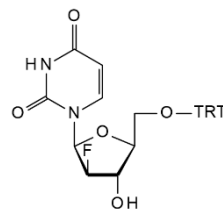

**3'-Deoxy-3'-fluoro-5'-O-tritylthymidine**[135197-63-6] C<sub>29</sub>H<sub>27</sub>FN<sub>2</sub>O<sub>4</sub> 486.53

ND04744

25mg	\$100.00
50mg	\$184.00
100mg	\$357.00

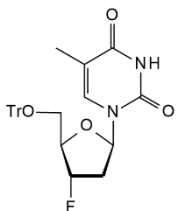
**2'-Deoxy-5-fluoro-uridine 3',5'-bis(4-chlorobenzoate)**

see 3',5'-Di-O-p-chlorobenzoyl-2'-deoxy-5-fluorouridine, ND22463 on page 236

**2'-Deoxy-5-fluorouridine 5'-diphosphate sodium salt**

• 5F-dUDP

ND31488

Price On Application

**2'-Deoxy-5-fluorouridine 5'-monophosphate sodium salt**

• 5F-dUMP

[103226-10-4] C<sub>9</sub>H<sub>10</sub>FN<sub>2</sub>O<sub>8</sub>P<sub>2</sub>Na 370.14

ND15883

1mg	\$85.00
2mg	\$125.00
5mg	\$230.00

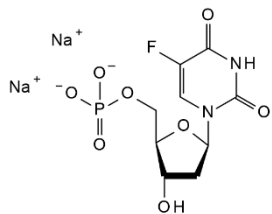
**2'-Deoxy-2'-fluorouridine-5'-monophosphate**

• 2'-Deoxy-2'-fluoro-5'-uridylic acid

[50270-97-8] C<sub>9</sub>H<sub>12</sub>FN<sub>2</sub>O<sub>8</sub>P 326.17

ND145456

Price On Application

**2'-Deoxy-2'-fluorouridine-5'-triphosphate lithium salt - 100mM aqueous solution**

• 2'-F-dUTP.Li

C<sub>9</sub>H<sub>14</sub>N<sub>2</sub>O<sub>14</sub>P<sub>3</sub>F<sub>2</sub>Li 486.13 (free acid basis)

ND46156

1mg	\$95.00
2.5mg	\$187.50
5mg	\$325.00

**2'-Deoxy-2'-fluorouridine-5'-triphosphate sodium salt - 100mM aqueous solution**

• 2'F-dUTP.Na

[66840-02-6] C<sub>9</sub>H<sub>14</sub>FN<sub>2</sub>O<sub>14</sub>P<sub>3</sub>Na 509.12

ND157275

2.5mg	\$150.00
5mg	\$250.00
10mg	\$390.00

**2'-Deoxy-5-fluorouridine-5'-triphosphate sodium salt**

• 5F-dUTP

C<sub>9</sub>H<sub>10</sub>FN<sub>2</sub>O<sub>14</sub>P<sub>3</sub>4Na 574.06

ND31483

Price On Application

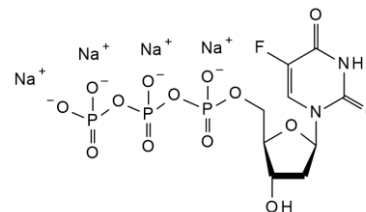

**Deoxyfluorou****2'-Deoxy-2'-fluorouridine-5'-triphosphate tetralithium salt**[66840-02-6] C<sub>9</sub>H<sub>11</sub>FN<sub>2</sub>O<sub>14</sub>P<sub>3</sub>Li<sub>4</sub> 510.87

ND09528

1mg	\$65.00
2mg	\$110.00
5mg	\$225.00

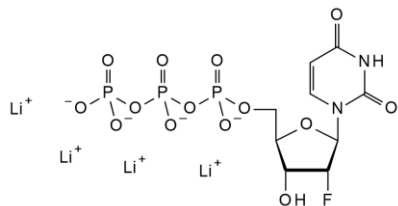
**2'-Deoxy-2'-fluoro-L-uridine**

• 1-(2-Deoxy-2-fluoro-b-L-ribofuranosyl) uracil

[622785-69-7] C<sub>9</sub>H<sub>11</sub>FN<sub>2</sub>O<sub>5</sub> 246.2

ND02886

Price On Application

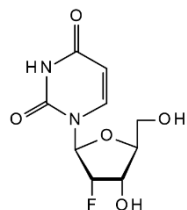
**2'-Deoxy-2'-fluorouridine**

• 1-(2'-Fluoro-2'-deoxy-b-D-ribofuranosyl)uracil

[784-71-4] C<sub>9</sub>H<sub>11</sub>FN<sub>2</sub>O<sub>5</sub> 246.2

ND06544

5g	\$70.00
10g	\$125.00
25g	\$225.00

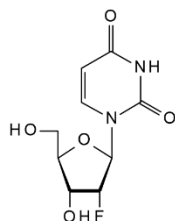

Refs: Richardson FC, Tennant BC, Meyer DJ, Richardson KA, Mann PC, McGinty GR, Wolf JL, Zack PM, Bendele RA, Toxicological Pathology 1999, Vol27, No6, p607-617

**2'-Deoxy-5-fluorouridine**

- 5-Fluoro-2'-deoxy-D-uridine
- Floxuridine

[50-91-9] C<sub>9</sub>H<sub>11</sub>FN<sub>2</sub>O<sub>5</sub> 246.2

ND02921

2g	\$44.00
5g	\$70.00
10g	\$110.00

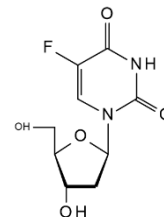

Refs: Harris M, et al, Biophys. J. 1964, 4, p203

**5'-Deoxy-5-fluorouridine**

- Doxifluridine
- 5'dUrd, 5-fluoro-5'-deoxyuridine, 5'-DFUR, doxifluridine

[3094-09-5][38817-29-7] C<sub>9</sub>H<sub>11</sub>FN<sub>2</sub>O<sub>5</sub> 246.2

ND02968

2g	\$65.00
5g	\$95.00
10g	\$150.00

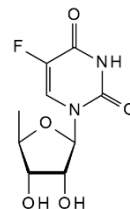

Refs: De Cesane, M, et al, Cancer Res, 49, 5969 (1994); Di Bartolomeo, M, et al, Tumori, 81, 147(1995)

**2'-Deoxy-2'-fluoro-5'-uridylic acid**

see 2'-Deoxy-2'-fluorouridine-5'-monophosphate, ND145456 on page 203

**9-(3'-O-Deoxy-3'-fluoro-b-D-xylofuranosyl)adenine**

ND137583

Price On Application





## 1-(3'-Deoxy-3'-fluoro-b-D-xylofuranosyl)cytosine

ND137581

Price On Application



## 1-(3'-Deoxy-3'-fluoro-b-D-xylofuranosyl)-5-methyluracil

ND137579

Price On Application



## 1-(3'-Deoxy-3'-fluoro-b-D-xylofuranosyl)uracil

ND137580

Price On Application



## 2'-Deoxy-5-formylcytidine

[137017-45-9] C<sub>10</sub>H<sub>13</sub>N<sub>3</sub>O<sub>5</sub> 255.23

ND63556

1mg	\$85.00
2mg	\$150.00
5mg	\$275.00

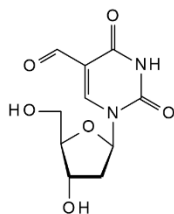

## 2'-Deoxy-5-formyluridine

[4494-26-2] C<sub>10</sub>H<sub>12</sub>N<sub>2</sub>O<sub>6</sub> 256.21

ND29039

10mg	\$85.00
25mg	\$175.00
50mg	\$315.00



## 2'-Deoxyguanosine-5'-diphosphate disodium salt

• dGDP.Na

[102783-74-4] C<sub>10</sub>H<sub>13</sub>N<sub>5</sub>O<sub>10</sub>P<sub>2</sub>·2Na 471.16

ND31607

25mg	\$125.00
50mg	\$195.00
100mg	\$350.00

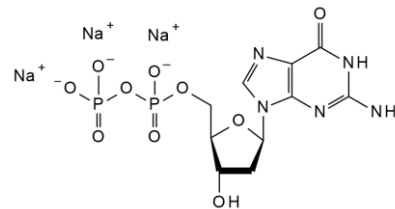

## 2'-Deoxyguanosine monohydrate

• 9-(2-Deoxy-b-D-erythro-pentofuranosyl)guanine monohydrate

[961-07-9][312693-72-4] C<sub>10</sub>H<sub>13</sub>N<sub>5</sub>O<sub>4</sub>·H<sub>2</sub>O 285.26

ND06306

10g	\$55.00
25g	\$85.00
50g	\$160.00

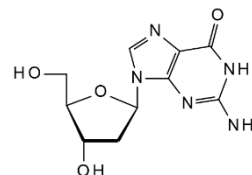

Refs: Martin JC, McGee DPC, Jeffrey GA, Hobbs DW, J. Med. Chem, 1986



## 2'-Deoxyguanosine-5'-monophosphate disodium salt

• 5'-dGMP Na<sub>2</sub>[33430-61-4] C<sub>10</sub>H<sub>12</sub>N<sub>5</sub>Na<sub>2</sub>O<sub>7</sub>P 391.19

ND02996

1g	\$60.00
2g	\$110.00
5g	\$225.00



**Deoxyguanosine****2'-Deoxyguanosine-5'-monophosphate free acid**

- 5'-Deoxyguanylic acid,
- dGMP

[902-04-5] C<sub>10</sub>H<sub>14</sub>N<sub>5</sub>O<sub>7</sub>P 347.22

ND29406

Price On Application

**2'-Deoxyguanosine-5'-triphosphate sodium salt - 100mmol solution**

- dGTP.Na

[2564-35-4] C<sub>10</sub>H<sub>16</sub>N<sub>5</sub>O<sub>13</sub>P<sub>3</sub> 507.18

ND46292

50mg  
100mg\$125.00  
\$220.00**2'-Deoxyguanosine 3'-monophosphate sodium salt**[102814-03-9] C<sub>10</sub>H<sub>12</sub>N<sub>5</sub>O<sub>7</sub>P·2Na 391.19

ND05424

100mg	\$63.00
250mg	\$120.00
500mg	\$200.00

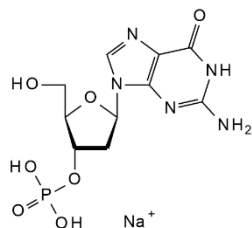
**2'-Deoxyguanosine-5'-triphosphate trisodium salt**

- 5'-dGTP Na<sub>3</sub>

[93919-41-6][2564-35-4][18423-40-0] C<sub>10</sub>H<sub>13</sub>N<sub>5</sub>O<sub>13</sub>P<sub>3</sub>·3Na 573.13

ND06585

50mg	\$55.00
100mg	\$80.00
250mg	\$150.00

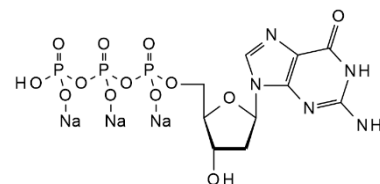
**2'-Deoxyguanosine-5'-O-(1-thiotriphosphate) lithium salt - 100mM aqueous solution**

- a-Thio-dGTP

[80902-28-9] C<sub>10</sub>H<sub>16</sub>N<sub>5</sub>O<sub>12</sub>P<sub>3</sub>S·xLi 523.25 (free acid basis)

ND32068

Price On Application

**2'-Deoxy-a-guanosine**[19916-78-0] C<sub>10</sub>H<sub>13</sub>N<sub>5</sub>O<sub>4</sub> 267.25

ND09163

10mg	\$95.00
25mg	\$185.00
50mg	\$275.00

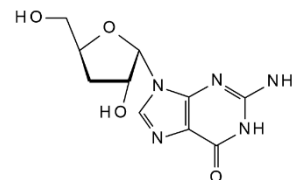
**3'-Deoxyguanosine-5'-triphosphate lithium salt - 100mM aqueous solution**

ND71669

0.5mg	\$130.00
1mg	\$220.00
2.5mg	\$475.00



D

**2'-Deoxy-L-guanosine**

• 9-(2-deoxy-b-L-erythro-pentofuranosyl)guanine

[22837-44-1] C<sub>10</sub>H<sub>13</sub>N<sub>5</sub>O<sub>4</sub> 267.25

ND05774

100mg	\$125.00
200mg	\$190.00
500mg	\$350.00

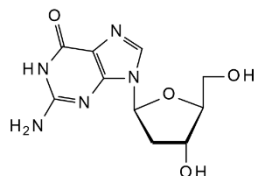

Refs: Urata H, Ogura E, Shinohara K, Ueda Y, Akagi M, Nucleic Acids Res. 1992, July 11, 20(13), 3325-3332

**3'-Deoxyguanosine**[3608-58-0] C<sub>10</sub>H<sub>13</sub>N<sub>5</sub>O<sub>4</sub> 267.25

ND06319

25mg	\$50.00
50mg	\$85.00
100mg	\$155.00

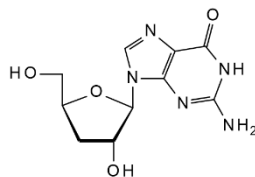

Refs: Barai VN, Zinchenko AI, Erosheskaya LA, Zhernosek EV, De Clercq E, Mikhailopolu IA, Helv. Chim. Acta 2002, Vol85, Issue 7, p1893-1900

**N-(2'-Deoxyguanosin-8-yl)-4-amino(biphenyl-2',3',4',5',6'-D5)**

see 8-(4-Amino-(2',3',4',5',6'-D5-biphenyl)-2'-deoxyguanosine, NA04647 on page 39

**N-(2'-Deoxyguanosin-8-yl)-4-amino(biphenyl)**• DG-C8-ABP  
• 8-(4-Biphenylamino)-2'-deoxyguanosine[84283-08-9] C<sub>22</sub>H<sub>22</sub>N<sub>6</sub>O<sub>4</sub> 434.45

ND11672

Price On Application

**N-(Deoxyguanosin-8-yl)-2-amino-1-methyl-6-phenylimidazo[4,5-b]pyridine**

see 8-(2-Amino-1-methyl-6-phenylimidazo[4,5-b]pyridyl)-2'-deoxyguanosine, NA04649 on page 58

**N-(Deoxyguanosin-8-yl)-2-amino-1-methyl-D3-6-phenylimidazo[4,5-b]pyridine**

see 8-(2-Amino-1-methyl-D3-6-phenylimidazo[4,5-b]pyridyl)-2'-deoxyguanosine, NA05715 on page 58

**5'-Deoxyguanylic acid,**

see 2'-Deoxyguanosine-5'-monophosphate free acid, ND29406 on page 206

**2'-Deoxy-8-hydroxyadenosine**

see 2'-Deoxy-8-oxo-adenosine, ND02928 on page 217

**2'-Deoxy-5-hydroxycytidine**[52278-77-0] C<sub>9</sub>H<sub>13</sub>N<sub>3</sub>O<sub>5</sub> 243.22

ND02927

2mg	\$40.00
5mg	\$90.00
10mg	\$150.00

**2'-Deoxy-5-hydroxymethylcytidine-5'-triphosphate lithium salt - 100 mM aqueous solution**

• 5-Hydroxymethyl-dCTP.Li

C<sub>10</sub>H<sub>18</sub>N<sub>3</sub>O<sub>14</sub>P<sub>3</sub> 497.18

ND71643

500ug	\$150.00
1mg	\$250.00
2mg	\$475.00



**Deoxyhydroxy****2'-Deoxy-5-hydroxymethyluridine-5'-triphosphate triethylammonium salt**C<sub>10</sub>H<sub>13</sub>N<sub>2</sub>O<sub>15</sub>P<sub>3</sub>·4C<sub>6</sub>H<sub>15</sub>N 902.93

ND15243

0.5mg	\$175.00
1mg	\$295.00
2mg	\$550.00

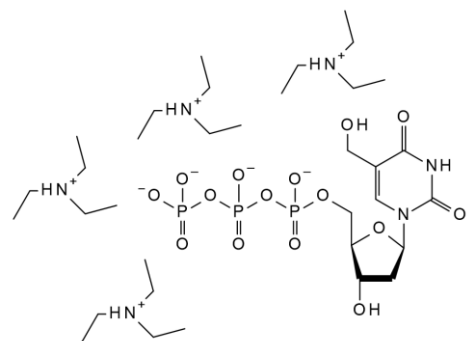
**2'-Deoxy-5-hydroxymethyluridine**[5116-24-5] C<sub>10</sub>H<sub>14</sub>N<sub>2</sub>O<sub>6</sub> 258.23

ND08018

25mg	\$66.00
50mg	\$105.00
100mg	\$158.00

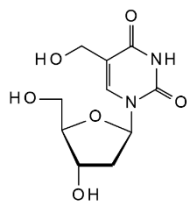
**2'-Deoxy-5-hydroxyuridine**[5168-36-5] C<sub>9</sub>H<sub>12</sub>N<sub>2</sub>O<sub>6</sub> 244.21

ND08235

10mg	\$52.50
25mg	\$100.00
50mg	\$168.00

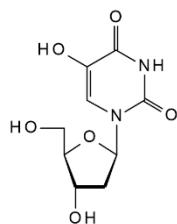
**2'-Deoxyinosine-5'-monophosphate disodium salt**[14999-52-1] C<sub>10</sub>H<sub>11</sub>N<sub>4</sub>Na<sub>2</sub>O<sub>7</sub>P 376.17

ND13488

100mg	\$50.00
250mg	\$75.00
500mg	\$115.00

**2'-Deoxyinosine-5'-triphosphate sodium salt**[95648-77-4][16595-02-1] C<sub>10</sub>H<sub>15</sub>N<sub>4</sub>O<sub>13</sub>P<sub>3</sub>·xNa 492.17 (free acid basis)

ND46159

5mg	\$75.00
10mg	\$120.00
20mg	\$200.00

**2'-Deoxyinosine**[890-38-0] C<sub>10</sub>H<sub>12</sub>N<sub>4</sub>O<sub>4</sub> 252.23

ND05750

10g	\$75.00
25g	\$125.00
50g	\$245.00

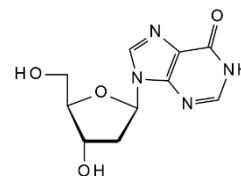

Refs: Ciuffreda P, Casati S, Santaniello E, Bioorg. Med. Chem. Lett. 1999, Vol9, No11, p1625-1630

**5'-Deoxy-5'-iodoadenosine**[4099-81-4] C<sub>10</sub>H<sub>12</sub>N<sub>5</sub>O<sub>3</sub> 377.14

ND04751

10mg	\$65.00
25mg	\$95.00
50mg	\$170.00

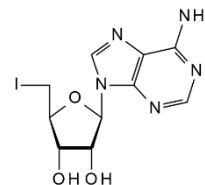

Refs: Jain TC, et al, J. Org. Chem. 1974, 39, p20

**2'-Deoxy-5-iodocytidine**[611-53-0] C<sub>9</sub>H<sub>12</sub>IN<sub>3</sub>O<sub>4</sub> 353.12

ND05777

1g	\$45.00
2g	\$85.00
5g	\$195.00

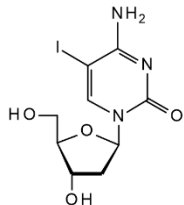
**2'-Deoxy-5-iodo-3',5'-di-O-p-toluoyluridine**[31356-86-2] C<sub>25</sub>H<sub>23</sub>IN<sub>2</sub>O<sub>7</sub> 590.36

ND138532

Price On Application

**2'-Deoxy-5-(2-iodoethyl)uridine**

[90301-67-0]

ND61524

Price On Application

**5'-Deoxy-5'-iodoguanosine**[68200-68-0] C<sub>10</sub>H<sub>12</sub>IN<sub>5</sub>O<sub>4</sub> 393.14

ND16029

100mg	\$1500.00
-------	-----------

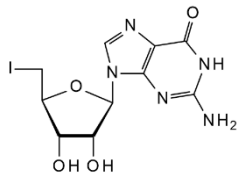
**5'-Deoxy-5'-iodo-2',3'-O-isopropylidene-5-chlorouridine**

• 5-Chloro-5'-deoxy-5'-iodo-2',3'-O-(1-methylethylidene)uridine

[94048-47-2] C<sub>12</sub>H<sub>14</sub>ClIN<sub>2</sub>O<sub>5</sub> 428.61

ND16525

50mg	\$99.50
100mg	\$181.00
250mg	\$330.00

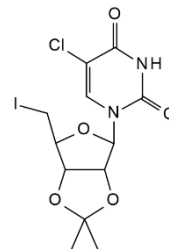
**1-Deoxy-1-[6-((3-iodophenyl)methyl)amino]-9H-purin-9-yl]-N-methyl-b-D-ribofuranuronamide**see *N(6)-(3-Iodobenzyl)-5'-N-methylcarboxamidoadenosine, NI10756 on page 294***2'-Deoxy-5-iodo-2-pyrimidinone-D-ribose**

ND09265

Price On Application

**3'-Deoxy-3'-iodothymidine**[14260-82-3] C<sub>10</sub>H<sub>13</sub>IN<sub>2</sub>O<sub>4</sub> 352.13

ND07899

1mg	\$42.00
2mg	\$63.00
5mg	\$131.30

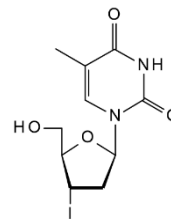

Refs: Chu CK, et.al, J. Med. Chem, 1989, 32, p612



## Deoxyiodothy

## 5'-Deoxy-5'-iodothymidine

[25953-14-4] C<sub>10</sub>H<sub>13</sub>IN<sub>2</sub>O<sub>4</sub> 352.13

ND06454

25mg	\$70.00
50mg	\$125.00
100mg	\$190.00

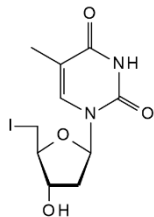

## 2'-deoxy-7-Iodotubercidin

see 7-Deaza-2'-deoxy-7-iodoadenosine, ND06190 on page 167

## 2'-Deoxy-5-iodouridine-5'-triphosphate sodium salt - 10mM aqueous solution

• 5I-dUTP

[3731-55-3] C<sub>9</sub>H<sub>10</sub>N<sub>2</sub>O<sub>14</sub>P<sub>3</sub>·4Na 681.97

ND31484

1mg	\$350.00
2.5mg	\$625.00

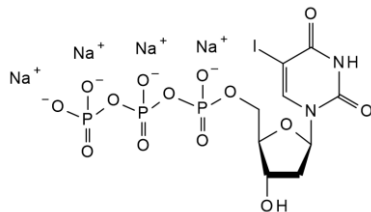

## 2'-Deoxy-5-iodouridine

- 1-(2-Deoxy-β-D-ribofuranosyl)-5-iodouracil
- Idoxuridine
- Dendrid

[54-42-2] C<sub>9</sub>H<sub>11</sub>IN<sub>2</sub>O<sub>5</sub> 354.1

ND05147

10g	\$85.00
25g	\$165.00
50g	\$325.00

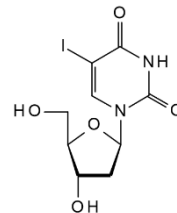

Refs: Spadari S, Maga G, Verri A, Focher F, Expert Opinion On Invest. Drugs 1998, 7, 8, p1285; Pressacco J, et al, Cancer Res. 1994, 54, p3772

## 2'-Deoxy-L-5-iodouridine

see ent-idoxuridine, NE16541 on page 267

## 5'-Deoxy-5'-iodouridine

[14259-58-6]

ND144937

Price On Application



## 2'-Deoxy-N2-isobutryl-a-cytidine

C<sub>13</sub>H<sub>19</sub>N<sub>3</sub>O<sub>5</sub> 297.31

ND08530

10mg	\$157.50
25mg	\$262.50
50mg	\$420.00

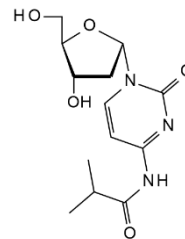

**2'-Deoxy-N2-isobutyrylcytidine**[110522-75-3] C<sub>13</sub>H<sub>19</sub>N<sub>5</sub>O<sub>5</sub> 297.31

ND02994

100mg	\$90.00
250mg	\$157.50
500mg	\$265.00

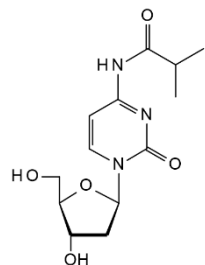
**2'-Deoxy-N2-isobutyryl-5'-O-levulinoyladenine**C<sub>19</sub>H<sub>25</sub>N<sub>5</sub>O<sub>6</sub> 419.44

NI06926

Price On Application

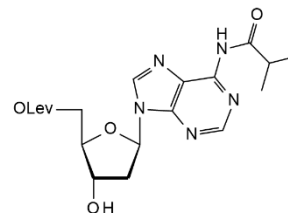
**2'-Deoxy-N2-isobutyryl-2'-fluoroguanosine**[80681-25-0] C<sub>14</sub>H<sub>18</sub>FN<sub>5</sub>O<sub>5</sub> 355.32

NI57535

Price On Application

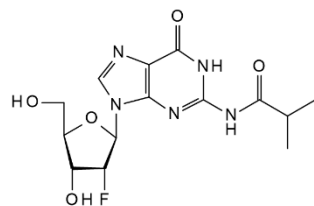
**2'-Deoxy-N2-isobutyryl-3'-O-levulinoylguanosine**

• 2'-Deoxy-N-isobutyrylguanosine 3'-levulinate

[93134-41-9] C<sub>19</sub>H<sub>25</sub>N<sub>5</sub>O<sub>6</sub> 419.44

NI06927

Price On Application

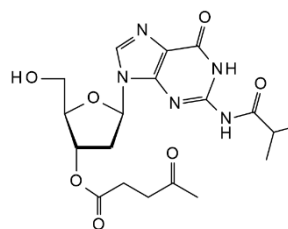
**2'-Deoxy-N-isobutyrylguanosine 3'-levulinate**

see 2'-Deoxy-N2-isobutyryl-3'-O-levulinoylguanosine, NI06927 on page 211

**2'-Deoxy-N2-isobutyryl-5'-O-levulinoylguanosine**C<sub>19</sub>H<sub>25</sub>N<sub>5</sub>O<sub>7</sub> 435.43

ND45586

Price On Application

**2'-Deoxy-N2-isobutyrylguanosine**

• N2-Isobutyryl-2'-deoxyguanosine

[68892-42-2][142554-22-1] C<sub>14</sub>H<sub>19</sub>N<sub>5</sub>O<sub>5</sub> 337.34

ND02989

5g	\$60.00
10g	\$110.00
25g	\$225.00

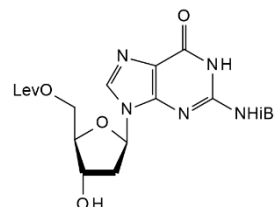
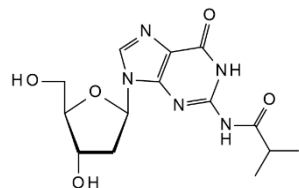

## Deoxyisobuty

## 2'-Deoxy-N2-isobutyryl-5'-O-MMT-guanosine

C<sub>34</sub>H<sub>35</sub>N<sub>5</sub>O<sub>6</sub> 609.69

ND08536

Price On Application

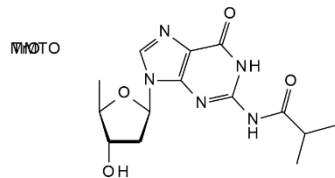

## 2'-Deoxy-N2-Isobutyryl-3',5'-O-(1,1,3,3-tetraisopropyl-1,3-disiloxanediy)guanosine

ND157584

250mg	\$50.00
500mg	\$85.00
1g	\$150.00



## 2'-Deoxy-N2-isobutyryl-5'-O-tritylguanosine

C<sub>33</sub>H<sub>33</sub>N<sub>5</sub>O<sub>5</sub> 579.66

ND08535

Price On Application

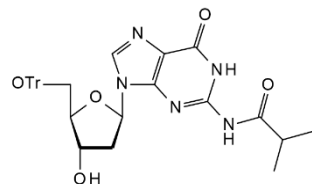

## 2'-Deoxyisocytidine

[123075-23-0] C<sub>9</sub>H<sub>13</sub>N<sub>3</sub>O<sub>4</sub> 227.22

ND30844

25mg	\$85.00
50mg	\$150.00
100mg	\$250.00



## 2'-Deoxyisoguanine

see 9-(2-Deoxy-b-D-ribofuranosyl)isoguanine, ND10029 on page 220

## 2'-Deoxy-N2-isopropylguanosine

C<sub>13</sub>H<sub>19</sub>N<sub>5</sub>O<sub>4</sub> 309.33

ND08533

1g	\$89.30
2g	\$157.50
5g	\$262.50

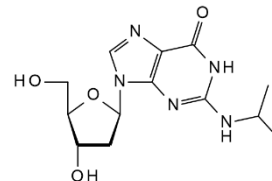

## 2'-Deoxy-5-isopropyluridine

see 5-Isopropyl-2'-deoxyuridine, NI16765 on page 298

## 3'-Deoxy-N6-lauroyladenosine

• N6-Lauroylcordycepin

[77378-06-4] C<sub>22</sub>H<sub>35</sub>N<sub>5</sub>O<sub>4</sub> 433.54

ND10014

1mg	\$78.80
2mg	\$136.50
5mg	\$236.30

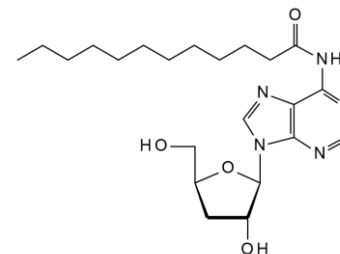

## 2'-Deoxy-3'-O-levulinoylthymidine

[78635-98-0] C<sub>15</sub>H<sub>20</sub>N<sub>2</sub>O<sub>7</sub> 340.33

ND16367

Price On Application

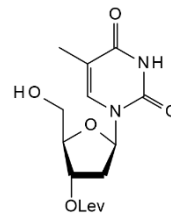



**2'-Deoxy-2-methoxyadenosine**

• 2-Methoxy-2'-deoxyadenosine

[24757-70-8] C<sub>11</sub>H<sub>15</sub>N<sub>5</sub>O<sub>4</sub> 281.27

ND15747

5mg	\$175.00
10mg	\$330.00
25mg	\$700.00

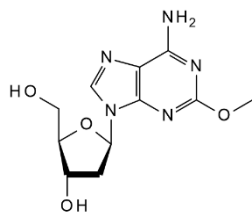
**1-(2-Deoxy-5-O-(4-methoxytrityl)-beta-D-threo-penta-furanosyl)-5-methyluracil**

see 1-(2-Deoxy-5-O-MMT-b-D-xylofuranosyl)-5-methyluracil, ND144732 on page 217

**3'-Deoxy-5-methoxyuridine**

ND144816

Price On Application

**2'-Deoxy-N6-methyladenosine 5'-triphosphate sodium salt**

• DM6ATP

C<sub>11</sub>H<sub>15</sub>N<sub>5</sub>Na<sub>3</sub>O<sub>12</sub>P<sub>3</sub> 571.15

ND71654

Price On Application

**2'-Deoxy-N6-methyladenosine**[2002-35-9] C<sub>11</sub>H<sub>15</sub>N<sub>5</sub>O<sub>3</sub> 265.27

ND06386

25mg	\$50.00
50mg	\$89.50
100mg	\$158.00

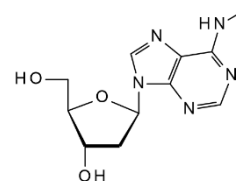
**3'-Deoxy-2'-O-methyladenosine**C<sub>11</sub>H<sub>15</sub>N<sub>5</sub>O<sub>3</sub> 265.27

ND08558

5mg	\$63.00
10mg	\$105.00
25mg	\$210.00

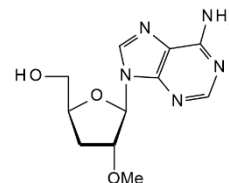
**3'-Deoxy-3'C-methyladenosine**

[26383-05-1]

ND157123

Price On Application

**2'-Deoxy-5-methylcytidine HCl**[5241-10-1] C<sub>10</sub>H<sub>15</sub>N<sub>3</sub>O<sub>4</sub>·HCl 277.71

ND08562

50mg	\$47.50
100mg	\$79.00
250mg	\$100.00

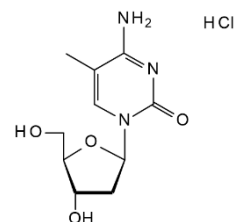

**Deoxymethylc****2'-Deoxy-N3-methylcytidine hydroiodide salt**C<sub>10</sub>H<sub>17</sub>N<sub>3</sub>O<sub>4</sub>·HI 371.17

ND06231

25mg	\$65.00
50mg	\$110.00
100mg	\$195.00

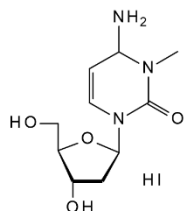
**2'-Deoxy-5-methylcytidine-5'-monophosphate disodium salt**

• 5-MedCMP

[2498-41-1] C<sub>10</sub>H<sub>14</sub>N<sub>3</sub>O<sub>7</sub>P·2Na 365.19

ND10012

10mg	\$126.00
25mg	\$262.50
50mg	\$410.00

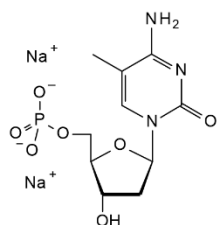
**2'-Deoxy-N4-methylcytidine 5'-triphosphate lithium salt - 100 mM aqueous solution**

• N4-Methyl-dCTP

C<sub>10</sub>H<sub>18</sub>N<sub>3</sub>O<sub>13</sub>P<sub>3</sub> 481.18

ND71658

500ug	\$175.00
1mg	\$325.00
2mg	\$580.00

**2'-Deoxy-5-methylcytidine-5'-triphosphate sodium salt - 10 mM aqueous solution**

• 5-Methyl-dCTP

[22003-12-9] C<sub>10</sub>H<sub>18</sub>N<sub>3</sub>O<sub>13</sub>P<sub>3</sub> 481.18

ND71642

250ug	\$180.00
500ug	\$275.00
1mg	\$495.00

**2'-Deoxy-5-methylcytidine**[838-07-3] C<sub>10</sub>H<sub>15</sub>N<sub>3</sub>O<sub>4</sub> 241.25

ND06242

500mg	\$70.00
1g	\$110.00
2g	\$200.00

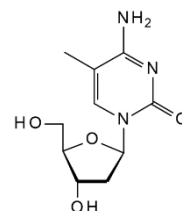
**2'-Deoxy-N4-methylcytidine**• N4-Methyldeoxycytidine  
• N4-Me-dC[22882-02-6] C<sub>10</sub>H<sub>15</sub>N<sub>3</sub>O<sub>4</sub> 241.24

ND153424

Price On Application



**3'-Deoxy-3'-C-methylcytidine**[444020-09-1] C<sub>10</sub>H<sub>15</sub>N<sub>3</sub>O<sub>4</sub> 241.24

ND15622

Price On Application

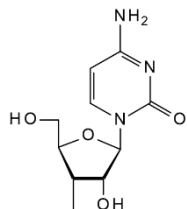
**3'-Deoxy-3'-alpha-C-methyl-N6,N6-dimethyladenosine**

ND144756

Price On Application

**2'-Deoxy-2'-methyleneadenosine**[104409-41-8] C<sub>11</sub>H<sub>13</sub>N<sub>5</sub>O<sub>3</sub> 263.25

ND157322

500mg	\$1475.00
1g	\$2075.00
2g	\$3500.00

**2'-Deoxy-5-(1-methylethyl)uridine***see 5-Isopropyl-2'-deoxyuridine, NI16765 on page 298***2'-Deoxy-6-O-methyl-guanosine**

• O6-Methyl-2'-deoxyguanosine

[964-21-6] C<sub>11</sub>H<sub>15</sub>N<sub>5</sub>O<sub>4</sub> 281.27

ND157121

5mg	\$110.00
10mg	\$180.00
25mg	\$350.00

**2'-Deoxy-N2-methylguanosine**[19916-77-9] C<sub>11</sub>H<sub>15</sub>N<sub>5</sub>O<sub>4</sub> 281.27

ND06236

5mg	\$95.00
10mg	\$175.00
25mg	\$250.00

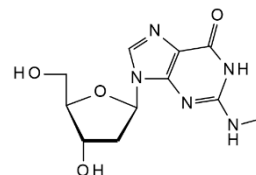
**3'-Deoxy-3'-methylguanosine**

• 3'-Deoxy-3'-C-methylguanosine

[444020-69-3] C<sub>11</sub>H<sub>15</sub>N<sub>5</sub>O<sub>4</sub> 281.27

ND144927

Price On Application

**2'-Deoxy-5-methyl-isocytidine triphosphate**

ND76410

Price On Application

**2'-Deoxy-5-methyl-isocytidine**

• 5-Methyl-iC

ND76392

Price On Application



## Deoxymethyli

**2'-Deoxy-5-methylisocytidine**

- 2-Amino-1-(2-deoxy-b-D-ribofuranosyl)-5-methyl-4(1H)-pyrimidinone
- 5-Methyl-2'-deoxyisocytidine

[19316-88-2] C<sub>10</sub>H<sub>15</sub>N<sub>3</sub>O<sub>4</sub> 241.24

ND144597	100mg	\$75.00
	250mg	\$125.00
	500mg	\$195.00

**3'-Deoxy-3'-C-methyl-5-methyluridine**

[847650-50-4]

Price On Application

ND144925

**5'-Deoxy-5'-(methylthio)adenosine**[2457-80-9] C<sub>11</sub>H<sub>15</sub>N<sub>5</sub>O<sub>3</sub>S 297.34

ND07992	50mg	\$95.00
	100mg	\$150.00
	250mg	\$300.00

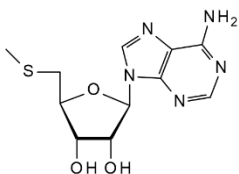
**2'-Deoxy-6-methylthioguanosine**[37113-42-1] C<sub>11</sub>H<sub>15</sub>N<sub>5</sub>O<sub>5</sub>S 297.33

ND71741	1mg	\$195.00
	2mg	\$370.00
	5mg	\$750.00

**2'-Deoxy-N3-methyluridine**[24514-32-7] C<sub>10</sub>H<sub>14</sub>N<sub>2</sub>O<sub>5</sub> 242.23

ND05865

25mg	\$95.00
50mg	\$150.00
100mg	\$260.00

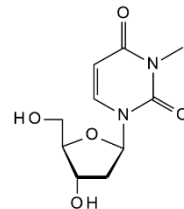
**3'-Deoxy-2'-C-methyluridine**

[934014-19-4]

Price On Application

ND14100

**3'-Deoxy-3'-C-methyluridine**

- 3'-Deoxy-3'-methyluridine

[444020-64-8] C<sub>10</sub>H<sub>14</sub>N<sub>2</sub>O<sub>5</sub> 242.23

ND15620

Price On Application

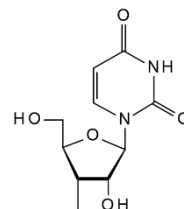
**3'-Deoxy-3'-methyluridine**

see 3'-Deoxy-3'-C-methyluridine, ND15620 on page 216

**3'-Deoxy-5-methyluridine**

• 5-Methyl-3'-deoxyuridine

[7084-29-9] C<sub>10</sub>H<sub>14</sub>N<sub>2</sub>O<sub>5</sub> 242.23

ND02776

5mg	\$65.00
10mg	\$115.00
25mg	\$205.00

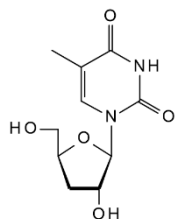
**1-(2-Deoxy-5-O-MMT-b-D-threo-pentofuranosyl)-5-fluorouracil**[121353-92-2] C<sub>29</sub>H<sub>27</sub>FN<sub>2</sub>O<sub>6</sub> 518.53

ND144733

Price On Application

**2'-Deoxy-5'-O-MMT-uridine**C<sub>29</sub>H<sub>28</sub>N<sub>2</sub>O<sub>6</sub> 500.56

ND09056

Price On Application

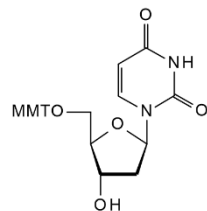
**1-(2-Deoxy-5-O-MMT-b-D-xylofuranosyl)-5-methyluracil**

• 1-(2-Deoxy-5-O-(4-methoxytrityl)-beta-D-threo-penta-furanosyl)-5-methyluracil

[124680-51-9]

ND144732

Price On Application

**1-(2-Deoxy-3-O-(4-nitrobenzenesulfonyl)-5-O-DMT-b-D-ribofuranosyl)-3-(tert-butyloxycarbonyl)thymine**

see 3-N-Boc-5'-O-DMT-3'-O-nosylthymidine, NB09438 on page 122

**2'-Deoxynucleoside-5'-triphosphate mixture**

ND02839

Price On Application

**3'-Deoxy-N6-octanoyladenine**• N6-Octanoyl cordycepin  
• N6-Octanoyl-3'-deoxyadenosine[77378-05-3] C<sub>18</sub>H<sub>27</sub>N<sub>5</sub>O<sub>4</sub> 377.44

ND10013

5mg	\$375.00
10mg	\$650.00
25mg	\$1000.00

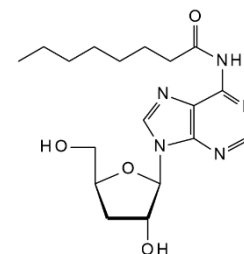
**2'-Deoxy-8-oxo-adenosine**• 2'-Deoxy-7,8-dihydro-8-oxo-adenosine  
• 2'-Deoxy-8-hydroxyadenosine[62471-63-0] C<sub>10</sub>H<sub>13</sub>N<sub>5</sub>O<sub>4</sub> 267.25

ND02928

1mg	\$46.00
2mg	\$71.00
5mg	\$136.50

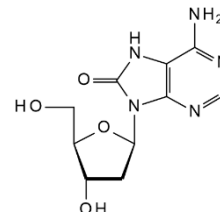

**Deoxyoxoguan****2'-Deoxy-8-oxoguanosine**

- 8-Hydroxy-2'-deoxyguanosine
- 8-Oxo-dG

[88847-89-6] C<sub>10</sub>H<sub>13</sub>N<sub>5</sub>O<sub>5</sub> 283.25

ND06344

10mg	\$65.00
25mg	\$125.00
50mg	\$225.00

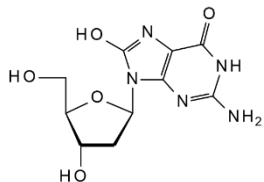

Refs: Lin T-S, et al, J. Med. Chem. 1985, 28, p1194; Orimo et al. Cancer Science 2006, 97, p99; Pilger, Ruediger, Int. Arch. Occup. Environ. Health 2006, 80, p1

**2'-Deoxy-8-oxo-6-thioguanosine 5'-triphosphate**

ND143189

Price On Application

**2'-Deoxy-N6-phenoxyacetyladenosine**[110522-74-2] C<sub>18</sub>H<sub>19</sub>N<sub>5</sub>O<sub>5</sub> 385.38

ND09200

250mg	\$105.00
500mg	\$160.00
1g	\$288.80

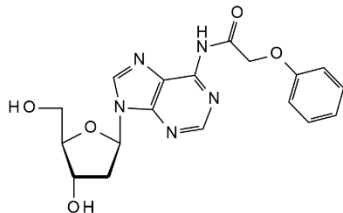
**2'-Deoxy-N2-phenoxyacetylguanosine**[115389-03-2] C<sub>18</sub>H<sub>19</sub>N<sub>5</sub>O<sub>6</sub> 401.38

ND08049

100mg	\$90.00
250mg	\$172.50
500mg	\$315.00

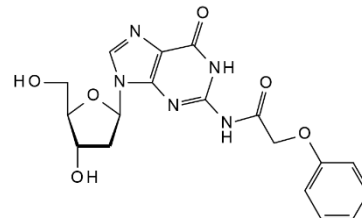
**2'-Deoxy-6-O-(phenylmethyl)guanosine 3',5'-diacetate**

see 3',5'-Di-O-acetyl O6-benzyl-2'-deoxyguanosine, ND16695 on page 229

**2'-Deoxy-6-O-(phenylmethyl)guanosine**

see 6-O-Benzyl-2'-deoxyguanosine, NB16627 on page 116

**2'-Deoxy-5'-O-pixylinosine**C<sub>30</sub>H<sub>26</sub>N<sub>4</sub>O<sub>4</sub> 506.57

ND08560

Price On Application

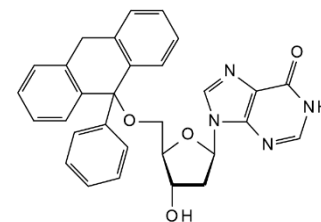
**2'-Deoxy-5'-O-pixyluridine**C<sub>28</sub>H<sub>24</sub>N<sub>2</sub>O<sub>6</sub> 484.51

ND08561

Price On Application

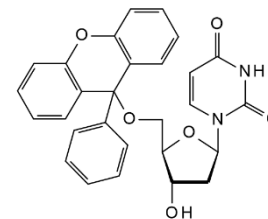

**2'-Deoxy-5-propargyloxyuridine**[65367-85-3] C<sub>12</sub>H<sub>14</sub>N<sub>2</sub>O<sub>6</sub> 282.26

ND08234

50mg	\$95.00
100mg	\$170.00
250mg	\$330.00

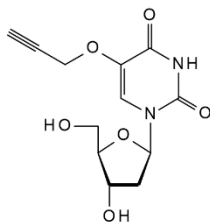
**2'-Deoxy-5-propynyluridine**C<sub>12</sub>H<sub>14</sub>N<sub>2</sub>O<sub>5</sub> 266.26

ND02838

50mg	\$84.00
100mg	\$158.00
250mg	\$315.00

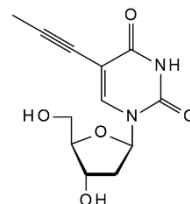
**3'-Deoxy-N6-propionyladenosine**

• N6-Propionylcordycepin

[77378-04-2] C<sub>13</sub>H<sub>17</sub>N<sub>5</sub>O<sub>4</sub> 307.31

ND10015

1mg	\$105.00
2mg	\$180.00
5mg	\$425.00

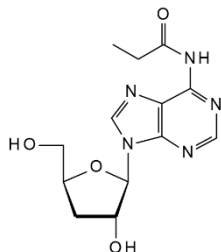
**2'-Deoxypseudoisocytidine**

• pidC

[65358-18-1] C<sub>9</sub>H<sub>13</sub>N<sub>3</sub>O<sub>4</sub> 227.22

ND63440

5mg	\$95.00
10mg	\$175.00
25mg	\$300.00

**2'-Deoxypseudouridine**[39967-60-7] C<sub>9</sub>H<sub>12</sub>N<sub>2</sub>O<sub>5</sub> 228.21

ND06413

1mg	\$40.00
2mg	\$60.00
5mg	\$100.00

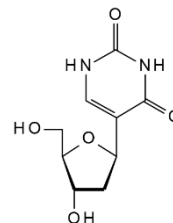
**2'-Deoxy-5-propynylcytidine**C<sub>12</sub>H<sub>15</sub>N<sub>3</sub>O<sub>4</sub> 265.27

ND02835

1mg	\$42.00
2mg	\$63.00
5mg	\$115.50

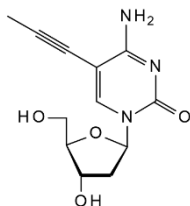
**9-(2-Deoxy-β-D-ribofuranosyl)-2,6-Diaminopurine**

see 2-Amino-2'-deoxyadenosine, NA06287 on page 45

**9-(2-Deoxy-β-D-ribofuranosyl)adenine**

see 2'-Deoxyadenosine, ND04011 on page 173

**9-(2-Deoxy-β-D-ribofuranosyl)-6-benzylaminopurine**

see N6-Benzyl-2'-deoxyadenosine, NB05230 on page 116

## Deoxyribofur

**9-(2-Deoxy-b-D-ribofuranosyl)-2-chloroadenine**

see 2-Chloro-2'-deoxyadenosine, NC06337 on page 141

**6-(b-D-2-Deoxyribofuranosyl)-3,4-dihydro-8H-pyrimido[4,5-c][1,2]oxazin-7-one**[126128-42-5] C<sub>11</sub>H<sub>15</sub>N<sub>3</sub>O<sub>5</sub> 269.25

ND145587

5mg	\$95.00
10mg	\$150.00
20mg	\$240.00

**(9-(2-Deoxy-b-D-ribofuranosyl)-2-fluoroadenine**

see 2'-Deoxy-2-fluoroadenosine, ND29528 on page 192

**1-(5-Deoxy-b-D-ribofuranosyl)-5-fluorocytidine**

see 5'-Deoxy-5-fluorocytidine, ND04700 on page 196

**[1-(5-Deoxy-b-D-ribofuranosyl)-5-fluoro-1,2-dihydro-2-oxo-4-pyrimidinyl]-carbamic acid 3-methylbutyl ester**

see 5'-Deoxy-5-fluoro-N-[(3-methylbutoxy)carbonyl]cytidine, ND16527 on page 199

**[1-(5-Deoxy-b-D-ribofuranosyl)-5-fluoro-1,2-dihydro-2-oxo-4-pyrimidinyl] carbamic acid pentyl ester**

see 5'-Deoxy-5-fluoro-N4-(pentylloxycarbonyl)cytidine, ND09160 on page 201

**8-(2-Deoxy-b-D-ribofuranosyl)-imidazo[1,2-a]-1,3,5-triazine-2,4(3H,8H)-dione**

• 8-(2-Deoxy-b-D-erythro-pentofuranosyl)-imidazo[1,2-a]-1,3,5-triazine-2,4(3H,8H)-dione

[357638-55-2] C<sub>10</sub>H<sub>12</sub>N<sub>4</sub>O<sub>5</sub> 268.23

ND145594

50mg	\$450.00
100mg	\$750.00
250mg	\$1625.00

**1-(2-Deoxy-b-D-ribofuranosyl)-5-iodouracil**

see 2'-Deoxy-5-iodouridine, ND05147 on page 210

**9-(2-Deoxy-b-D-ribofuranosyl)isoguanine**

• 2'-Deoxyisoguanine

[106449-56-3] C<sub>10</sub>H<sub>13</sub>N<sub>5</sub>O<sub>4</sub> 267.24

ND10029

50mg	\$95.00
100mg	\$175.00
250mg	\$350.00

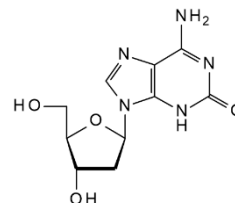
**1-(2-Deoxy-b-D-ribofuranosyl)-4-methylindole**[180420-84-2] C<sub>14</sub>H<sub>17</sub>NO<sub>3</sub> 247.3

ND06396

1mg	\$84.00
2mg	\$126.00
5mg	\$236.30

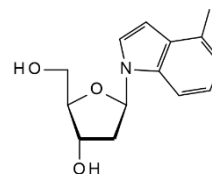
**1-(2-Deoxy-a-D-ribofuranosyl)-5-methyluracil**

see a-Thymidine, NT00283 on page 365

**1-(2-Deoxy-b-D-ribofuranosyl)-5-methyluracil**

see Thymidine, NT02592 on page 365

**1-(2-Deoxy-b-D-ribofuranosyl)-5-nitroindole**[191421-10-0] C<sub>13</sub>H<sub>14</sub>N<sub>2</sub>O<sub>5</sub> 278.26

ND10031

25mg	\$89.50
50mg	\$157.50
100mg	\$263.00

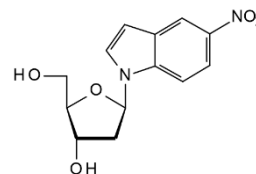



**2-(2-Deoxy-b-D-ribofuranosyl)-2,3,8,9-tetrahydro-7-oxa-2,3,5,6-tetraazabenz[cd]azulen-4-amine**[477205-38-2] C<sub>13</sub>H<sub>17</sub>N<sub>5</sub>O<sub>4</sub> 307.31

ND145590

50mg	\$850.00
100mg	\$1375.00
250mg	\$3000.00

**Deoxyribonucleic acid low molecular weight from salmon sperm**

• DNA

[100403-24-5]

ND35412

10g	\$65.00
25g	\$125.00
50g	\$225.00

**Deoxyribonucleic acid sodium salt - (Salmon)**

• DNA-Na

[9007-49-2]

ND10028

10g	\$65.00
25g	\$95.00
50g	\$150.00

**2'-Deoxy-3',5'-O-(1,1,3,3-tetraisopropyl-1,3-disiloxanediyl)uridine**[98495-56-8] C<sub>21</sub>H<sub>38</sub>N<sub>2</sub>O<sub>6</sub>Si<sub>2</sub> 470.72

ND08981

250mg	\$80.00
500mg	\$135.00
1g	\$204.80

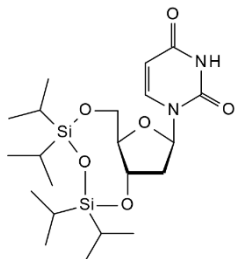
**2'-Deoxy-4'-thioadenosine**[135656-35-8] C<sub>10</sub>H<sub>13</sub>N<sub>5</sub>O<sub>2</sub>S 267.31

ND63590

Price On Application

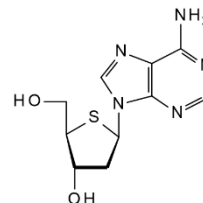
**2'-Deoxy-6-thioguanosine**[789-61-7] C<sub>10</sub>H<sub>13</sub>N<sub>5</sub>O<sub>3</sub>S 283.31

ND08563

5mg	\$70.00
10mg	\$110.00
25mg	\$175.00

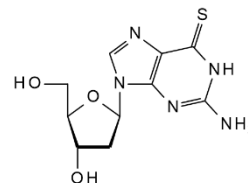
**2'-Deoxy-6-thioinosine**

see 6-Mercapto-9-(2'-deoxy-b-D-ribofuranosyl)purine, NM02964 on page 305

**2'-Deoxy-4'-thiouridine**[134111-32-3] C<sub>9</sub>H<sub>12</sub>N<sub>2</sub>O<sub>4</sub>S 244.27

ND63588

Price On Application

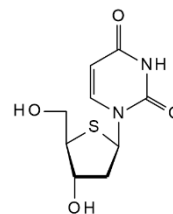

**Deoxythiouri****2'-Deoxy-4-thiouridine**C<sub>9</sub>H<sub>12</sub>N<sub>2</sub>O<sub>4</sub>S 244.27

ND06676

10mg	\$42.00
25mg	\$79.00
50mg	\$105.00

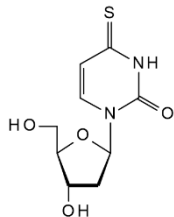
**1-(2-Deoxy-b-D-threo-pentofuranosyl)-5-iodo-2,4(1H,3H)-pyrimidinedione**see 3'-*epi*-idoxuridine, NE16543 on page 268**1-(2-Deoxy-b-D-threo-pentofuranosyl)-5-iodouracil**see 3'-*epi*-idoxuridine, NE16543 on page 268**2'-Deoxythymidine-3',5'-bisphosphate**

see Thymidine-3',5'-diphosphate sodium salt, NT09781 on page 363

**3'-Deoxythymidine-5'-triphosphate lithium salt - 100mM aqueous solution**

• dTTP

[128524-26-5] C<sub>10</sub>H<sub>17</sub>N<sub>2</sub>O<sub>13</sub>P<sub>3</sub>·xLi 466.17 (free acid basis)

ND32064	0.5mg	\$90.00
	2.5mg	\$200.00
	5mg	\$300.00

**2'-Deoxy-D-thymidine**

see Thymidine, NT02592 on page 365

**2'-Deoxy-L-thymidine**

see L-Thymidine, NT02679 on page 365

**3'-Deoxy-L-thymidine**

• 1;(2,3-Dideoxy-b-L-glycero-pentofuranosyl)thymine

[144490-02-8] C<sub>10</sub>H<sub>14</sub>N<sub>2</sub>O<sub>4</sub> 226.23

ND02766

250mg	\$850.00
500mg	\$1250.00
1g	\$1950.00

**3'-Deoxythymidine**[3416-05-5] C<sub>10</sub>H<sub>14</sub>N<sub>2</sub>O<sub>4</sub> 226.23

ND06301

50mg	\$50.00
100mg	\$80.00
250mg	\$122.50

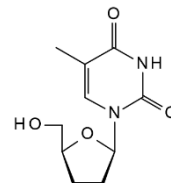

Refs: Schwarzer K, Wojczewski C, Engels JW, Nucleosides Nucleotides And Nucleic Acids 2001, Vol20, Pt4/7, p879-882; Yamanaka et.al., Biol. Pharmaceut. Bull, 1997, 20, p163; Seiser et al., J. Mol. Biol, 1997, 265, p153

**5'-Deoxythymidine**[3458-14-8] C<sub>10</sub>H<sub>14</sub>N<sub>2</sub>O<sub>4</sub> 226.23

ND08408

5mg	\$65.00
10mg	\$95.00
25mg	\$150.00

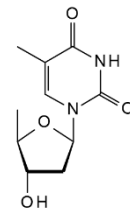

**2'-Deoxy-5'-O-p-toluenesulfonyluridine**[27999-47-9] C<sub>16</sub>H<sub>18</sub>N<sub>2</sub>O<sub>7</sub>S 382.4

ND06470

1g	\$157.50
2g	\$262.50
5g	\$420.00

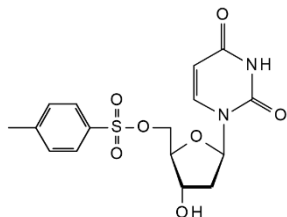
**2'-Deoxy-5-(trimethylstannyl)uridine**

see 5-(Trimethylstannyl)-2'-deoxyuridine, NT16878 on page 377

**2'-Deoxy-5'-triphosphocytidine trisodium salt**

see 2'-Deoxycytidine-5'-triphosphate trisodium salt, ND05687 on page 176

**2'-Deoxy-5'-O-trityluridine**

• 5'-O-Trt-2'-deoxyuridine

[14270-73-6] C<sub>28</sub>H<sub>28</sub>N<sub>2</sub>O<sub>5</sub> 470.52

NT08746

Price On Application

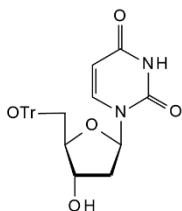
**3'-Deoxy-5'-O-trityluridine**[161110-05-0] C<sub>28</sub>H<sub>28</sub>N<sub>2</sub>O<sub>5</sub> 470.53

ND05370

10mg	\$73.50
25mg	\$136.50
50mg	\$231.00

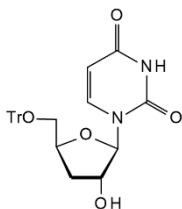

Refs: Lin TS, et al, J. Med. Chem 1991, 34, p693

**2-Deoxytubercidin**

see 7-Deaza-2'-deoxyadenosine, ND02936 on page 165

**2'-Deoxyuridine-5'-diphosphate sodium salt**[102814-06-2] C<sub>9</sub>H<sub>12</sub>N<sub>2</sub>Na<sub>2</sub>O<sub>11</sub>P<sub>2</sub> 432.13

ND45194

Price On Application

**2'-Deoxyuridine-5'-diphosphate triethylammonium salt - 10 mM aqueous solution**

• dUDP.NE13

[4208-67-7] C<sub>9</sub>H<sub>14</sub>N<sub>2</sub>O<sub>11</sub>P<sub>2</sub> 388.16

ND11202

1mg	\$295.00
2mg	\$500.00
5mg	\$975.00

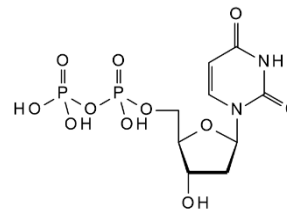
**2'-Deoxyuridine-5'-[(a,b)-imido]diphosphate sodium salt - 10mM aqueous solution**

• dUpNHp

[178809-71-7] C<sub>9</sub>H<sub>15</sub>N<sub>3</sub>O<sub>10</sub>P<sub>2</sub> 387.18

ND45195

1mg	\$400.00
2mg	\$590.00

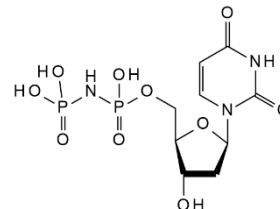

**Deoxyuridine****2'-Deoxyuridine-5'-[(a,b)-imido]triphosphate sodium salt - 10mM aqueous solution**

## • dUpNHpp

[170428-86-1] C<sub>9</sub>H<sub>16</sub>N<sub>3</sub>O<sub>13</sub>P<sub>3</sub> 467.16

200ug	\$250.00
1mg	\$625.00

ND45196

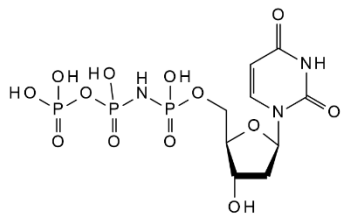
**2'-Deoxyuridine-5'-[(a,b)-methylene]diphosphate sodium salt - 10mM aqueous solution**

## • dUpCp

C<sub>10</sub>H<sub>16</sub>N<sub>2</sub>O<sub>10</sub>P<sub>2</sub> 386.19

1mg	\$395.00
2mg	\$600.00

ND45197

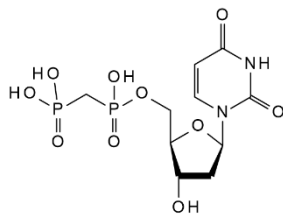
**2'-Deoxyuridine-5'-[(a,b)-methylene]triphosphate sodium salt - 10 mM aqueous solution**

## • dUpCpp

[170428-84-9] C<sub>10</sub>H<sub>17</sub>N<sub>2</sub>O<sub>13</sub>P<sub>3</sub> 466.17

1mg	\$625.00
-----	----------

ND45198

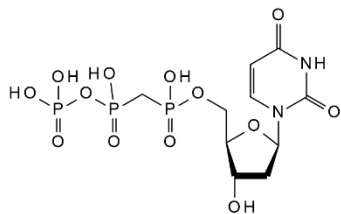
**2'-Deoxyuridine-5'-monophosphate disodium salt**• 5'-dUMP Na<sub>2</sub>[42155-08-8] C<sub>9</sub>H<sub>11</sub>N<sub>2</sub>O<sub>8</sub>PNa<sub>2</sub> 352.15

ND02992

500mg	\$45.00
1g	\$75.00
2g	\$140.00

**2'-Deoxyuridine-5'-monophosphate free acid**

## • 2'-Deoxy-5'-uridylic acid

[964-26-1] C<sub>9</sub>H<sub>13</sub>N<sub>2</sub>O<sub>8</sub>P 308.18

ND153405

Price On Application

**2'-Deoxyuridine-5'-triphosphate trisodium salt**

## • dUTP sodium salt

[102814-08-4] C<sub>9</sub>H<sub>12</sub>N<sub>2</sub>O<sub>14</sub>P<sub>3</sub>·3Na 534.09

ND08736

25mg	\$70.00
50mg	\$120.00
100mg	\$195.00

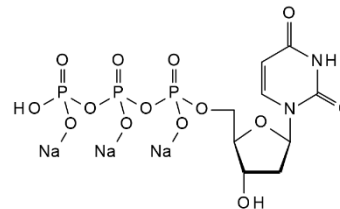
**3'-Deoxyuridine-5'-triphosphate**

ND71671

Price On Application



**2'-Deoxy-a-uridine**C<sub>9</sub>H<sub>12</sub>N<sub>2</sub>O<sub>5</sub> 228.21

ND08399

50mg	\$157.50
100mg	\$263.00
250mg	\$420.00

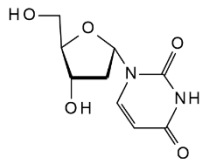
**2-Deoxyuridine**[21052-20-0] C<sub>9</sub>H<sub>12</sub>N<sub>2</sub>O<sub>5</sub> 228.2

ND59548

Price On Application

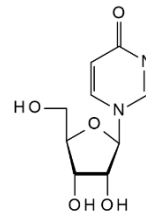
**2'-Deoxy-L-uridine**

• 1-(2-Deoxy-b-L-erythro-pentofuranosyl)uracil

[31501-19-6] C<sub>9</sub>H<sub>12</sub>N<sub>2</sub>O<sub>5</sub> 228.2

ND06307

250mg	\$52.50
500mg	\$90.00
1g	\$131.30

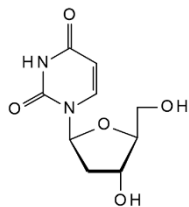

Refs: Verri A, et.al, Mol. Pharmacol, 1997, 51, p132

**3'-Deoxyuridine**[7057-27-4] C<sub>9</sub>H<sub>12</sub>N<sub>2</sub>O<sub>5</sub> 228.21

ND05963

25mg	\$165.00
50mg	\$245.00
100mg	\$440.00

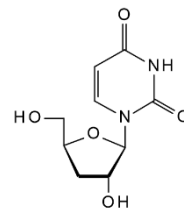

Refs: Lin TS, et al, J. Med. Chem. 1991, 34, 693

**2'-Deoxyuridine**[951-78-0] C<sub>9</sub>H<sub>12</sub>N<sub>2</sub>O<sub>5</sub> 228.21

ND06282

10g	\$55.00
25g	\$70.00
50g	\$125.00

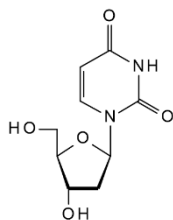

Refs: Persson, Larsson, Nyman, et al, Bioorg. Med. Chem. 1996, 4, 4, p553-556

**4-Deoxyuridine**

- Zebularine
- 1-b-D-Ribofuranosyl-2(1H)-pyrimidinone

[3690-10-6] C<sub>9</sub>H<sub>12</sub>N<sub>2</sub>O<sub>5</sub> 228.21

ND09503

50mg	\$50.00
100mg	\$63.00
250mg	\$132.50

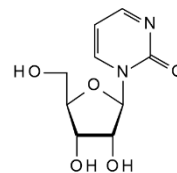

**Deoxyuridine****5'-Deoxyuridine**[15958-99-3] C<sub>9</sub>H<sub>12</sub>N<sub>2</sub>O<sub>5</sub> 228.21

ND08410

2mg	\$42.00
5mg	\$63.00
10mg	\$105.00

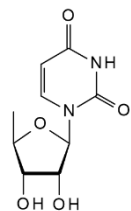
**2'-Deoxy-5'-uridylic acid**

see 2'-Deoxyuridine-5'-monophosphate free acid, ND153405 on page 224

**2'-Deoxyxanthosine**[29049-22-7] C<sub>10</sub>H<sub>12</sub>N<sub>4</sub>O<sub>5</sub> 268.23

ND12015

10mg	\$50.00
25mg	\$85.00
50mg	\$150.00

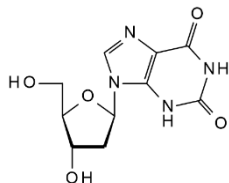
**dFdCTP**

see 2'-Deoxy-2',2'-difluorocytidine 5'-triphosphate triethylammonium salt - Aqueous solution, ND09708 on page 178

**DG-C8-ABP**

see N-(2'-Deoxyguanosin-8-yl)-4-amino(biphenyl), ND11672 on page 207

**3'-dG-CPG**

see 3'-Deoxy-N-dimethylformamide- 5'-O-DMT-guanosine-2'-O-succinoyl-long chain alkylamino-CPG, ND37120 on page 179

**dGDP.Na**

see 2'-Deoxyguanosine-5'-diphosphate disodium salt, ND31607 on page 205

**5'-dGMP Na2**

see 2'-Deoxyguanosine-5'-monophosphate disodium salt, ND02996 on page 205

**dGMP**

see 2'-Deoxyguanosine-5'-monophosphate free acid, ND29406 on page 206

**5'-dGTP Na3**

see 2'-Deoxyguanosine-5'-triphosphate trisodium salt, ND06585 on page 206

**dGTP.Na**

see 2'-Deoxyguanosine-5'-triphosphate sodium salt - 100mmol solution, ND46292 on page 206

**3',5'-Di-O-acetyl-N4-acetyl-2'-deoxycytidine**C<sub>15</sub>H<sub>19</sub>Na<sub>3</sub>O<sub>7</sub> 353.33

ND45045

1g	\$105.00
2g	\$170.00
5g	\$300.00

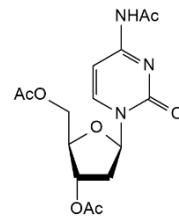
**2',3'-Di-O-acetyladenoside**[29886-19-9] C<sub>14</sub>H<sub>17</sub>N<sub>5</sub>O<sub>6</sub> 351.31

ND66842

1g	\$65.00
2g	\$126.00
5g	\$300.00

**3',5'-Di-O-acetyl-N4-benzoyl-2'-deoxycytidine**C<sub>20</sub>H<sub>21</sub>N<sub>3</sub>O<sub>7</sub> 415.41

ND09415

250mg	\$75.00
500mg	\$125.00
1g	\$195.00

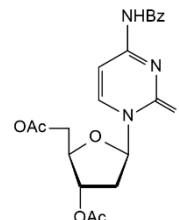

**3',5'-Di-O-acetyl-5-bromo-2'-deoxy-2'-fluorouridine**

ND15626

Price On Application

**3',5'-Di-O-acetyl-5-bromo-2'-deoxyuridine**[6161-23-5] C<sub>13</sub>H<sub>15</sub>BrN<sub>2</sub>O<sub>7</sub> 391.18

ND04658

1g	\$99.80
2g	\$189.00
5g	\$357.00

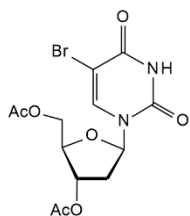

Refs: Low JN, Cryst. Struct. Commun. C39, 796-798

**3',5'-Di-O-acetyl-5-chloro-2'-deoxyuridine**[6046-63-5] C<sub>13</sub>H<sub>15</sub>ClN<sub>2</sub>O<sub>7</sub> 346.73

ND09546

Price On Application

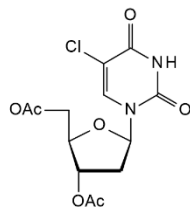
**2',3'-Di-O-acetyl-5'-deoxy-5-fluorocytidine**

• Capectabine

[161599-46-8] C<sub>13</sub>H<sub>16</sub>FN<sub>3</sub>O<sub>6</sub> 329.29

ND05721

5g	\$60.00
10g	\$100.00
25g	\$200.00

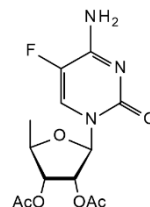
**3',5'-Di-O-acetyl-2'-deoxy-2'-fluoro-5-iodouridine**

ND15627

Price On Application

**2',3'-Di-O-acetyl-5'-deoxy-5-fluoro-N4-(pentoxycarbonyl)cytidine**[162204-20-8] C<sub>19</sub>H<sub>26</sub>FN<sub>3</sub>O<sub>8</sub> 443.43

ND04660

5mg	\$90.00
10mg	\$160.00
25mg	\$300.00

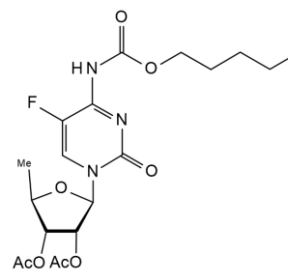

**Diacetyldeox****3',5'-Di-O-acetyl-2'-deoxy-2'-fluorouridine**[10212-13-2] C<sub>13</sub>H<sub>15</sub>FN<sub>2</sub>O<sub>7</sub> 330.27

ND08887

1g	\$190.00
2g	\$360.00
5g	\$750.00

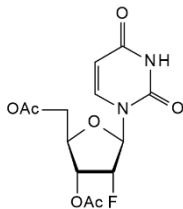
**3',5'-Di-O-acetyl-2'-deoxy-5-iodouridine**[1956-30-5] C<sub>13</sub>H<sub>15</sub>IN<sub>2</sub>O<sub>7</sub> 438.18

ND08349

250mg	\$132.50
500mg	\$210.00
1g	\$367.50

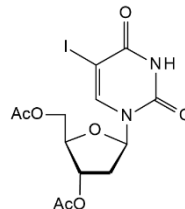
**3',5'-Di-O-acetyl-2'-deoxy-5-fluorouridine**[110522-47-9] C<sub>13</sub>H<sub>15</sub>FN<sub>2</sub>O<sub>7</sub> 330.27

ND06468

25mg	\$80.00
50mg	\$145.00
100mg	\$230.00

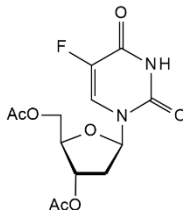
**2',3'-Di-O-acetyl-5'-deoxy-5-nitro-N4-(pentyloxycarbonyl)cytidine**[865474-03-9] C<sub>19</sub>H<sub>26</sub>N<sub>4</sub>O<sub>10</sub> 470.44

ND08738

Price On Application

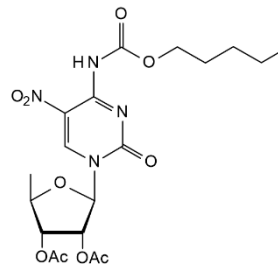

Refs: Xiangshu F, et.al, Nucl. Med. Biol, 204, 31, p1033

**3',5'-Di-O-acetyl-2'-deoxyguanosine**[69992-10-5] C<sub>14</sub>H<sub>17</sub>N<sub>5</sub>O<sub>6</sub> 351.32

ND04500

25mg	\$94.50
50mg	\$163.00
100mg	\$263.00

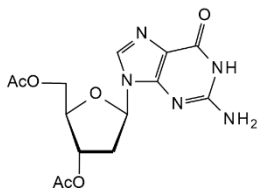
**1-(3,5-Di-O-acetyl-2-deoxy-b-D-ribofuranosyl)uracil**

see 3',5'-Di-O-acetyl-2'-deoxy-D-uridine, ND02986 on page 228

**3',5'-Di-O-acetyl-2'-deoxy-D-uridine**

• 1-(3,5-Di-O-acetyl-2-deoxy-b-D-ribofuranosyl)uracil

[13030-62-1] C<sub>13</sub>H<sub>16</sub>N<sub>2</sub>O<sub>7</sub> 312.28

ND02986

250mg	\$125.00
500mg	\$240.00
1g	\$393.80

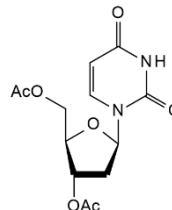



**2',3'-Di-O-acetyl-5'-O-DMT-5-methyluridine**

ND145914	500mg	\$50.00
	1g	\$96.00
	2g	\$184.00

**3',5'-Di-O-acetyl-2-fluoro-2'-O-trifluoromethanesulfonyladenosine**[161109-76-8] C<sub>15</sub>H<sub>15</sub>F<sub>4</sub>N<sub>5</sub>O<sub>8</sub>S 501.37

Price On Application

ND10387

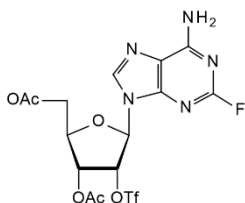
**3',5'-Di-O-acetyl O6-benzyl-2'-deoxyguanosine**

• 2'-Deoxy-6-O-(phenylmethyl)guanosine 3',5'-diacetate

[144640-75-5] C<sub>21</sub>H<sub>23</sub>N<sub>5</sub>O<sub>6</sub> 441.44

ND16695	10mg	\$139.80
	25mg	\$254.50
	50mg	\$462.00

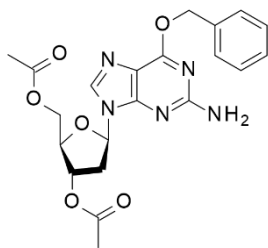

Refs: Wei, G. et al, J. Med. Chem, 48, 256 (2005)

**3',5'-Di-O-acetylthymidine**

ND145913	500mg	\$50.00
	1g	\$95.00
	2g	\$182.00

**2',3'-Di-O-acetyl-D-uridine**C<sub>13</sub>H<sub>16</sub>N<sub>2</sub>O<sub>8</sub> 328.27

ND45821	500mg	\$150.00
	1g	\$250.00
	2g	\$390.00

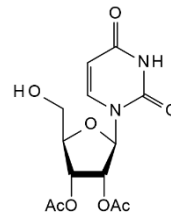
**Diadenosine pentaphosphate pentasodium salt**• P1,P5-Di(adenosine-5') pentaphosphate pentasodium salt  
• A(5')P5(5')A[4097-04-5] C<sub>20</sub>H<sub>28</sub>N<sub>10</sub>O<sub>22</sub>P<sub>5</sub>-5Na 1031.32

ND46856	2mg	\$70.00
	5mg	\$125.00
	10mg	\$210.00

**P1,P5-Di(adenosine-5') pentaphosphate pentasodium salt**see *Diadenosine pentaphosphate pentasodium salt, ND46856 on page 229***P1,P5-Di(adenosine-5')pentaphosphate trillithium salt**

• Ap5a

[75522-97-3] C<sub>20</sub>H<sub>26</sub>N<sub>10</sub>O<sub>22</sub>P<sub>5</sub>Li<sub>3</sub> 934.17

ND57347	25mg	\$65.00
	50mg	\$115.00
	100mg	\$180.00



## Diaminoamino

**2,6-Diamino-9-(2'-amino-2'-deoxy-b-D-ribofuranosyl)purine**

- 9-(2-Amino-2-deoxy-b-D-ribofuranosyl)-2,6-diaminopurine
- 2'-Amino-2'-deoxy-2,6-diaminopurine-D-riboside

[215943-79-6] C<sub>10</sub>H<sub>15</sub>N<sub>7</sub>O<sub>3</sub> 281.28

	50mg	\$66.00
ND06322	100mg	\$100.00
	250mg	\$225.00

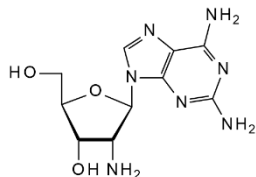
**2,6-Diamino-9-(2'-deoxy-2'-fluoro-b-D-arabinofuranosyl)purine**

- 2'-FANA-DAP

C<sub>10</sub>H<sub>13</sub>FN<sub>6</sub>O<sub>3</sub> 284.25

	25mg	\$60.00
ND09537	50mg	\$110.00
	100mg	\$190.00

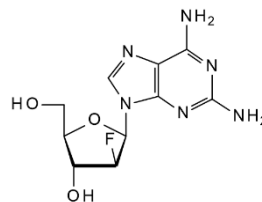
**2,6-Diamino-9-(3'-amino-2',3'-dideoxy-b-D-ribofuranosyl)purine**

- 9-(3-Amino-2,3-dideoxy-b-D-ribofuranosyl)-2,6-diaminopurine
- 3'-Amino-2',3'-dideoxy-2,6-diaminopurine riboside

C<sub>10</sub>H<sub>15</sub>N<sub>7</sub>O<sub>2</sub> 265.28

	250mg	\$92.50
ND05219	500mg	\$160.00
	1g	\$210.00

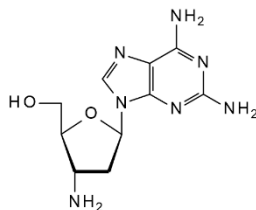
**2,6-Diamino-9-(2'-deoxy-2'-fluoro-b-D-ribofuranosyl)purine**C<sub>10</sub>H<sub>13</sub>FN<sub>6</sub>O<sub>3</sub> 284.25

	250mg	\$262.50
ND09538	500mg	\$420.00
	1g	\$735.00

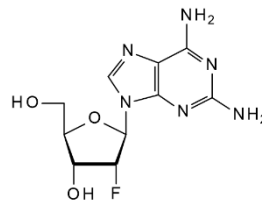
**2,6-Diamino-9-(b-D-arabinofuranosyl)purine**

- DAPA

[34079-68-0] C<sub>10</sub>H<sub>14</sub>N<sub>6</sub>O<sub>4</sub> 282.26

	1g	\$55.00
ND03400	2g	\$90.00
	5g	\$195.00

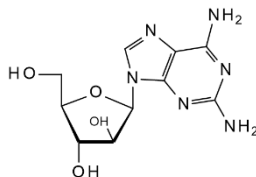
**2,6-Diamino-9-(3',5'-di-O-benzoyl-2'-deoxy-2'-fluoro-b-D-arabinofuranosyl)purine**

	10mg	\$50.00
ND157507	25mg	\$112.50
	50mg	\$200.00

**2,6-Diamino-9-(2'-deoxy-2'-fluoro-b-D-ribofuranosyl)purine**

see 2-Amino-2'-deoxy-2'-fluoro-adenosine, NA05649 on page 46

**2,5-Diamino-4,6-dichloropyrimidine**[55583-59-0] C<sub>4</sub>H<sub>4</sub>N<sub>4</sub>Cl<sub>2</sub> 179.01

ND16293

1g	\$45.00
2g	\$70.00
5g	\$125.00

**2,4-Diamino-6-(4-fluorophenyl)pyrimidine**

see 6-(4-Fluorophenyl)pyrimidine-2,4-diamine, NF57447 on page 279

**2,4-Diamino-6-hydroxy-5-nitrosopyrimidine**[2387-48-6] C<sub>4</sub>H<sub>5</sub>N<sub>5</sub>O<sub>2</sub> 155.12

ND69830

1g	\$60.00
2g	\$80.00
5g	\$95.00

**3',5'-Diamino-3',5'-dideoxyadenosine**[67313-23-9] C<sub>10</sub>H<sub>13</sub>N<sub>7</sub>O<sub>2</sub> 265.28

ND08739

1mg	\$420.00
2mg	\$735.00
5mg	\$1575.00

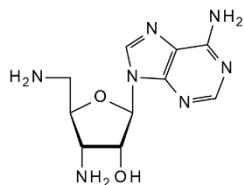

Refs: Morr, Ernst, Chem. Ber, 1979, 112, p2815

**2,4-Diamino-6-hydroxypyridine sulphate**

ND69917

10g	\$50.00
25g	\$100.00
50g	\$180.00

**2,4-Diamino-6-mercapto-pyrimidine sulfate**

[307496-37-3]

ND44271

1g	\$92.80
2g	\$148.50
5g	\$237.50

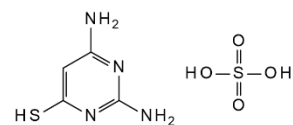
**2,6-Diamino-9-(2'-O-methyl-b-D-ribofuranosyl)purine**

• 2'-O-Methyl-2,6-diaminopurine riboside

C<sub>11</sub>H<sub>16</sub>N<sub>6</sub>O<sub>4</sub> 296.29

ND08564

250mg	\$157.50
500mg	\$265.00
1g	\$472.50

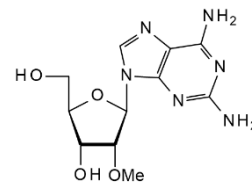
**5,6-Diamino-2,4-dihydroxypyrimidine sulphate**

see 5,6-Diaminouracil, ND66272 on page 232

**2,5-Diamino-4,6-dihydroxy pyrimidine**

[40769-69-5]

ND44297

Price On Application

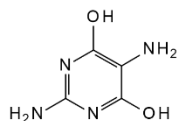
**2,4-Diamino-6,7-dimethylpteridine**

• DIHYDRALAZINE

[1425-63-4] C<sub>8</sub>H<sub>10</sub>N<sub>6</sub> 190.21

ND71063

500g	\$60.00
1g	\$98.00
2g	\$156.80



**Diaminomethyl****2,6-Diamino-9-(3'-O-methyl-b-D-ribofuranosyl)purine**C<sub>11</sub>H<sub>16</sub>N<sub>6</sub>O<sub>4</sub> 296.29

ND08740

50mg	\$140.00
100mg	\$250.00
250mg	\$475.00

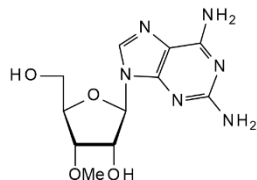
**5,6-Diaminouracil**

• 5,6-Diamino-2,4-dihydropyrimidine sulphate

[3240-72-0] C<sub>4</sub>H<sub>6</sub>N<sub>4</sub>O<sub>2</sub> 142.12

ND66272

10mg	\$30.00
25mg	\$60.00
50mg	\$96.00

**2',3'-Di-O-benzoyl-N6-benzoyl-L-adenosine**

• N-[9-(2,3-Di-O-benzoyl-b-L-ribofuranosyl)-9H-purin-6-yl]-benzamide

[200562-12-5] C<sub>31</sub>H<sub>25</sub>N<sub>5</sub>O<sub>7</sub> 579.56

ND145163

Price On Application

**2,6-Diaminopurine-2'-deoxyriboside**

see 2'-Amino-2'-deoxyadenosine, NA02636 on page 45

**2,6-Diaminopurine 2'-deoxyriboside**

see 2'-Amino-2'-deoxyadenosine, NA06287 on page 45

**2,6-Diaminopurine riboside**

see 2'-Aminoadenosine, NA02915 on page 33

**2,6-Diamino-9-[3',5'-O-(1,1,3,3-tetraisopropyl-1,3-disiloxanediy)-b-D-ribofuranosyl]purine**

• 3',5'-TIPPS-2,6-diaminopurine riboside

C<sub>22</sub>H<sub>40</sub>N<sub>6</sub>O<sub>5</sub>Si<sub>2</sub> 524.77

ND08565

500mg	\$105.00
1g	\$157.50
2g	\$262.50

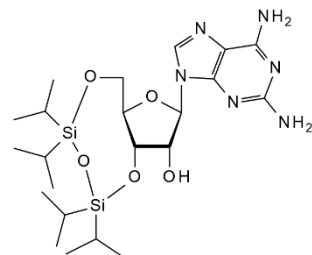
**N6,3'-O-Dibenzoyl-2'-deoxyadenosine**[51549-54-3] C<sub>24</sub>H<sub>21</sub>N<sub>5</sub>O<sub>5</sub> 459.47

ND07994

50mg	\$84.00
100mg	\$158.00
250mg	\$262.50

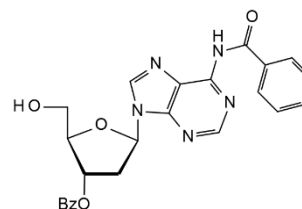
**N6,5'-O-Dibenzoyl-2'-deoxy-adenosine**C<sub>24</sub>H<sub>21</sub>N<sub>5</sub>O<sub>5</sub> 475.45

ND06914

Price On Application



**N4,3'-O-Dibenzoyl-2'-deoxycytidine**[51549-49-6] C<sub>23</sub>H<sub>21</sub>N<sub>3</sub>O<sub>6</sub> 435.44

ND07995

10mg	\$89.30
25mg	\$157.50
50mg	\$262.50

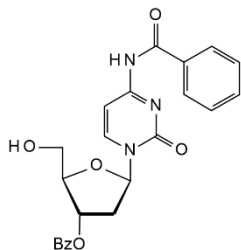
**N4,5'-O-Dibenzoyl-2'-deoxycytidine**C<sub>23</sub>H<sub>21</sub>N<sub>3</sub>O<sub>6</sub> 435.44

ND06913

Price On Application

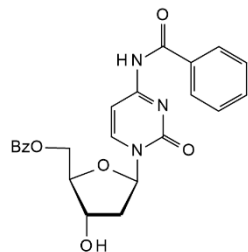
**3',5'-Di-O-benzoyl-2'-deoxy-2',2'-difluorocytidine**

- 2',2'-Difluoro-3',5'-dibenzoyl-2'-deoxycytidine
- Gemcitabine HCl

[134790-39-9] C<sub>23</sub>H<sub>19</sub>F<sub>2</sub>N<sub>3</sub>O<sub>6</sub> 471.42

ND08303

1g	\$45.00
2g	\$70.00
5g	\$125.00

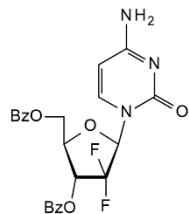
**3',5'-Di-O-benzoyl-2'-deoxy-2',2'-difluorouridine**

• 2',2'-Difluoro-2'-deoxyuridine 3',5'-dibenzoate

[143157-27-1] C<sub>23</sub>H<sub>18</sub>F<sub>2</sub>N<sub>2</sub>O<sub>7</sub> 472.4

ND16691

5mg	\$90.00
10mg	\$140.00
25mg	\$250.00

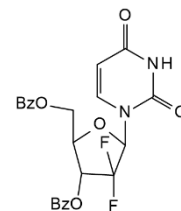
**1-(3',5'-Di-O-benzoyl-2'-deoxy-2'-fluoro-b-D-arabinofuranosyl)-5-bromouracil**[213136-12-0] C<sub>23</sub>H<sub>18</sub>BrN<sub>2</sub>O<sub>7</sub> 514.3

ND58419

25mg	\$97.25
50mg	\$155.50
100mg	\$249.00

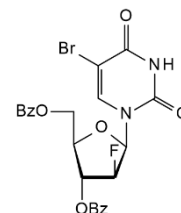
**1-(3',5'-Di-O-benzoyl-2'-deoxy-2'-fluoro-b-D-arabinofuranosyl)-thymine**

[97614-47-6]

ND58420

100mg	\$60.00
250mg	\$445.00
500mg	\$710.00



**Dibenzoyldeo****1-(3',5'-Di-O-benzoyl-2'-deoxy-2'-fluoro-b-D-arabinofuranosyl)thymine**C<sub>23</sub>H<sub>19</sub>FN<sub>2</sub>O<sub>7</sub> 454.42

ND08485

25mg	\$68.50
50mg	\$100.00
100mg	\$184.00

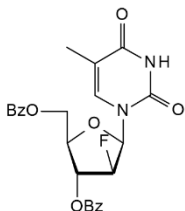
**3',5'-Di-O-benzoyl-5-fluoro-2'-O-methyluridine**[158966-44-0] C<sub>24</sub>H<sub>21</sub>FN<sub>2</sub>O<sub>8</sub> 484.44

ND06453

50mg	\$65.00
100mg	\$115.00
250mg	\$190.00

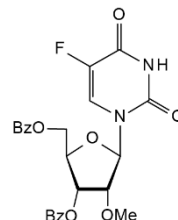
**1-(3',5'-Di-O-benzoyl-2'-deoxy-2'-fluoro-b-D-arabinofuranosyl)uracil**C<sub>23</sub>H<sub>19</sub>N<sub>2</sub>O<sub>7</sub>F 454.4

ND34656

50mg	\$90.00
100mg	\$145.00
250mg	\$250.00

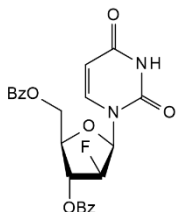
**2',3'-Di-O-benzoyluridine**[50408-20-3] C<sub>23</sub>H<sub>20</sub>N<sub>2</sub>O<sub>8</sub> 452.41

ND66563

100mg	\$50.00
250mg	\$67.50
500mg	\$125.00

**3',5'-Di-O-benzoyl-2'-deoxy-2'-fluorouridine**C<sub>23</sub>H<sub>19</sub>FN<sub>2</sub>O<sub>7</sub> 454.42

ND08486

50mg	\$94.50
100mg	\$158.00
250mg	\$262.50

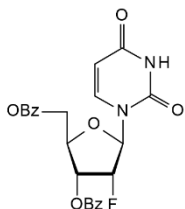
**N2-Diboc-7/9-(2,3,4,6-tetra-O-acetyl-D-mannopyranosyl)-6-chloro-2-aminopurine**

• N2-Diboc-7/9-(2,3,4,6-tetra-O-acetyl-D-mannopyranosyl)-6-chloroguanine

C<sub>21</sub>H<sub>30</sub>ClN<sub>5</sub>O<sub>9</sub> 531.94

ND09536

25mg	\$262.50
50mg	\$472.50
100mg	\$840.00

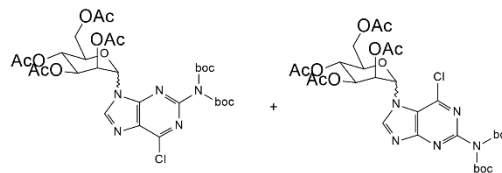
**N2-Diboc-7/9-(2,3,4,6-tetra-O-acetyl-D-mannopyranosyl)-6-chloroguanine**

see N2-Diboc-7/9-(2,3,4,6-tetra-O-acetyl-D-mannopyranosyl)-6-chloro-2-aminopurine, ND09536 on page 234

**3',5'-O-(Di-tert-butylsilanediyl)uridine**

[97219-04-0]

ND72055

Price On Application

**N6,2'-O-Dibutyryladenosine 3',5'-cyclic monophosphate calcium salt**

- Calcium dibutyryladenosine cyclophosphate
- Bucladesine calcium salt
- Dibutyryl-cAMP calcium salt

[938448-87-4] C<sub>18</sub>H<sub>24</sub>N<sub>5</sub>O<sub>8</sub>P·1/2Ca 489.42

NC11728

500mg	\$65.00
1g	\$105.00
2g	\$160.00

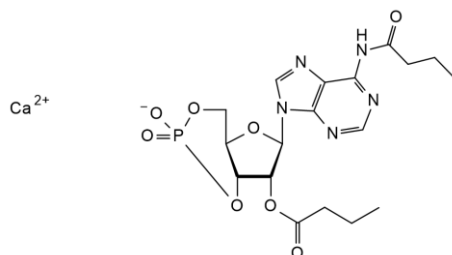
**N6,2'-O-Dibutyryladenosine 3',5'-cyclic monophosphate sodium salt**

- Dibutyryl-cAMP sodium salt
- DB-cAMP . Na
- Bucladesine Na

[16980-89-5] C<sub>18</sub>H<sub>23</sub>N<sub>5</sub>O<sub>8</sub>P·Na 491.38

ND07996

250mg	\$62.50
500mg	\$100.00
1g	\$150.00

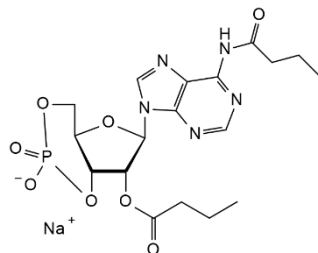
**Dibutyryl-cAMP calcium salt**see *N6,2'-O-Dibutyryladenosine 3',5'-cyclic monophosphate calcium salt, NC11728 on page 235***Dibutyryl-cAMP sodium salt**see *N6,2'-O-Dibutyryladenosine 3',5'-cyclic monophosphate sodium salt, ND07996 on page 235***(S)-N-(1,2-Dicarboxyethyl)adenosine**see *N6-Succinyl adenosine, NS16562 on page 354***6-(1,2-Dicarboxyethylamino)-9-b-D-ribofuranosylpurine**see *N6-Succinyl adenosine, NS16562 on page 354***5,6-Dichlorobenzimidazole-1-b-D-ribofuranoside**

- DBR
- 5,6-Dichlorobenzimidazole riboside

[53-85-0] C<sub>12</sub>H<sub>12</sub>Cl<sub>2</sub>N<sub>2</sub>O<sub>4</sub> 319.15

ND06701

25mg	\$60.00
50mg	\$100.00
100mg	\$145.00

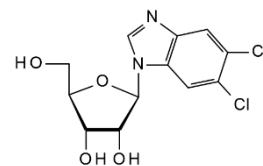

Refs: Braedlye J, Sporns O, Brain Res, 1999, 815, p140; Ljungman M, et.al, Oncogene, 1999, 18, p583; Roelle RH, et.al, Oncogene, 1999, 18, p5765; Tamm, Sehgal, Adv. Virus. Res, 1978, 22, p187

**5,6-Dichlorobenzimidazole riboside**see *5,6-Dichloro-1-(b-D-ribofuranosyl) benzimidazole, ND08933 on page 237***5,6-Dichlorobenzimidazole riboside**see *5,6-Dichlorobenzimidazole-1-b-D-ribofuranoside, ND06701 on page 235***3,5-Di-O-p-chlorobenzoyl a-floxuridine**see *3',5'-Di-O-p-chlorobenzoyl-2'-deoxy a-5-fluorouridine, ND22464 on page 236*

**Dichlorobenz****3',5'-Di-O-p-chlorobenzoyl-2'-deoxy a-5-fluorouridine**

- 2'-Deoxy-3,5-di-O-p-chlorobenzoyl-a-D-ribofuranosyl-5-fluorouracil
- 3,5-Di-O-p-chlorobenzoyl a-floxuridine
- 1-[3,5-Bis-O-(4-chlorobenzoyl)-2-deoxy-a-D-erythro-pentofuranosyl]-5-fluoro-2,4(1H,3H)-pyrimidinedione

[110558-30-0] C<sub>23</sub>H<sub>17</sub>Cl<sub>2</sub>FN<sub>2</sub>O<sub>7</sub> 523.29

ND22464

5mg	\$140.00
10mg	\$254.50
25mg	\$463.00

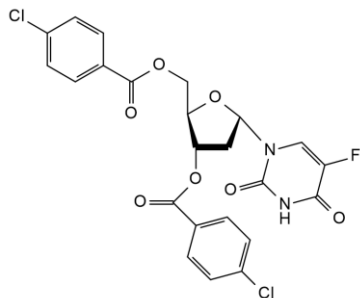
**3',5'-Di-O-p-chlorobenzoyl-2'-deoxy-5-fluorouridine**

- 2'-Deoxy-5-fluoro-uridine 3',5'-bis(4-chlorobenzoate)
- 3,5-Di-O-p-chlorobenzoyl floxuridine

[1582-79-2] C<sub>23</sub>H<sub>17</sub>Cl<sub>2</sub>FN<sub>2</sub>O<sub>7</sub> 523.29

ND22463

50mg	\$99.50
100mg	\$181.00
250mg	\$330.00

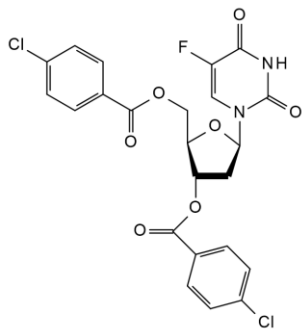

Refs: Kanzawa, F, et al, Canc. Chemother. Pharmacol, 6, 19 (1981)

**3,5-Di-O-p-chlorobenzoyl floxuridine**

see 3',5'-Di-O-p-chlorobenzoyl-2'-deoxy-5-fluorouridine, ND22463 on page 236

**2,6-Dichloro-9-(2'-deoxy-b-D-ribofuranosyl)purine**

- 2,6-Dichloropurine-2'-deoxyriboside

[37390-66-2] C<sub>10</sub>H<sub>10</sub>Cl<sub>2</sub>N<sub>4</sub>O<sub>3</sub> 305.12

ND08402

50mg	\$157.50
100mg	\$263.00
250mg	\$525.00

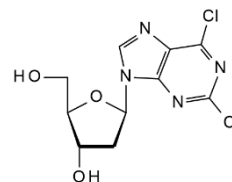
**2,6-Dichloro-9-(3',5'-di-O-benzoyl-2'-deoxy-2'-fluoro-b-D-arabinofuranosyl)purine**C<sub>24</sub>H<sub>17</sub>Cl<sub>2</sub>FN<sub>4</sub>O<sub>5</sub> 531.33

ND08487

50mg	\$63.00
100mg	\$105.00
250mg	\$262.50

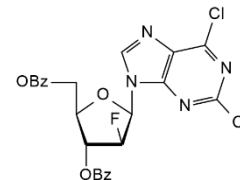
**4,6-Dichloro-5-methoxypyrimidine**[5018-38-2] C<sub>5</sub>H<sub>4</sub>Cl<sub>2</sub>N<sub>2</sub>O 179

ND11522

5g	\$68.60
10g	\$109.70
25g	\$175.50

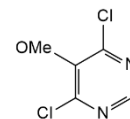
**2,6-Dichloro-7-methylpurine**[2273-93-0] C<sub>6</sub>H<sub>4</sub>Cl<sub>2</sub>N<sub>4</sub> 203.03

ND29030

25mg	\$97.50
50mg	\$175.00
100mg	\$290.00





**4,6-Dichloro-2-methylsulfonylpyrimidine**

[4489-34-3]

ND44280

5g	\$91.60
10g	\$146.60
25g	\$234.50

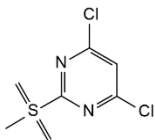
**2,4-Dichloro-5-nitro-6-methylpyrimidine**

ND70435

10g	\$50.00
25g	\$100.00
50g	\$180.00

**3,5-Dichloro-4-oxo-1(4H)-pyridine acetic acid**see *3,5-Dichloro-4-pyridone-1-acetic acid*, ND70436 on page 237**2,6-Dichloropurine b-D-ribose**see *2,6-Dichloro-9-(b-D-ribofuranosyl)purine*, ND05330 on page 238**2,6-Dichloropurine-2'-deoxyribose**see *2,6-Dichloro-9-(2'-deoxy-b-D-ribofuranosyl)purine*, ND08402 on page 236**5,6-Dichloropurine-1-(2,3,5-tri-O-acetyl-b-D-ribofuranosyl)-1H-benzimidazole**• *5,6-Dichloro-1-(2,3,5-tri-O-acetyl-b-D-ribofuranosyl)-1H-benzimidazole*[443678-71-5] C<sub>18</sub>H<sub>18</sub>Cl<sub>2</sub>N<sub>2</sub>O<sub>7</sub> 445.25

ND16534	50mg	\$120.50
	100mg	\$219.00
	250mg	\$397.50

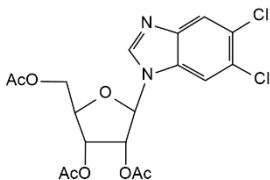

Refs: Braedlye, J. and Sporns, O. *Brain Res*, 815, 140 (1999); Ljungman, M. et al, *Oncogene*, 18, 583 (1999); Roele, R.H. et al, *Oncogene*, 18, 5765 (1999)

**3,5-Dichloro-4-pyridone-1-acetic acid**• *3,5-Dichloro-4-oxo-1(4H)-pyridine acetic acid*[56187-37-2] C<sub>7</sub>H<sub>5</sub>Cl<sub>2</sub>NO<sub>3</sub> 222.02

ND70436

25g	\$55.00
50g	\$85.00
100g	\$150.00

**5,6-Dichloro-(1-b-D-ribofuranosyl) benzimidazole 3',5'-cyclic monophosphothioate, Sp-isomer sodium salt**[120912-54-1] C<sub>12</sub>H<sub>10</sub>Cl<sub>2</sub>N<sub>2</sub>O<sub>5</sub>P-Na 419.16

ND08934

0.5mg	\$262.50
1mg	\$420.00
2mg	\$630.00

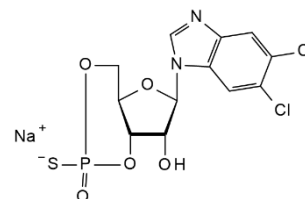
**5,6-Dichloro-1-(b-D-ribofuranosyl) benzimidazole**• *5,6-Dichlorobenzimidazole riboside*C<sub>12</sub>H<sub>12</sub>Cl<sub>2</sub>N<sub>2</sub>O<sub>4</sub> 319.15

ND08933

100mg	\$300.00
-------	----------

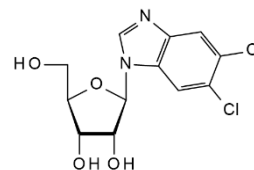

**Dichlororibio****2,6-Dichloro-9-(b-D-ribofuranosyl)purine**

• 2,6-Dichloropurine b-D-riboside

[13276-52-3] C<sub>10</sub>H<sub>10</sub>Cl<sub>2</sub>N<sub>4</sub>O<sub>4</sub> 321.12

ND05330

250mg	\$75.00
500mg	\$135.00
1g	\$225.00

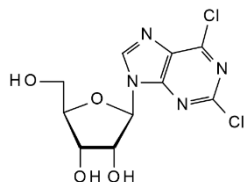

Refs: Havelkova M, Dvorak D, Hocek M, Synthesis 2001, p1704-1710; Hocek M, Holy A, Dvořakova H, Collect. Czech. Chem. Commun. 2002, 67(3), 325-335

**5,6-Dichloro-1-(2,3,5-tri-O-acetyl-b-D-ribofuranosyl)-1H-benzimidazole**

see 5,6-Dichloropurine-1-(2,3,5-tri-O-acetyl-b-D-ribofuranosyl)-1H-benzimidazole, ND16534 on page 237

**2,6-Dichloro-9-(2',3',5'-tri-O-acetyl-b-D-ribofuranosyl)purine**[3056-18-6] C<sub>16</sub>H<sub>16</sub>Cl<sub>2</sub>N<sub>4</sub>O<sub>7</sub> 447.23

ND04495

500mg	\$95.00
1g	\$157.50
2g	\$262.50

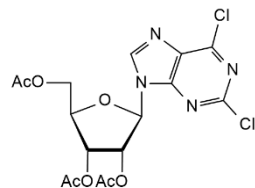
**Didanosine 5'-monophosphate sodium salt**

see 2',3'-Dideoxyinosine-5'-monophosphate sodium salt, ND28881 on page 244

**Didanosine 5'-monophosphate sodium salt**

see 2',3'-Dideoxyinosine-5'-monophosphate triethylammonium salt, ND15335 on page 244

**Didanosine 5'-triphosphate sodium salt**

see 2',3'-Dideoxyinosine-5'-triphosphate triethylammonium salt, ND10277 on page 244

**Didanosine**

see 2',3'-Dideoxyinosine, ND02929 on page 244

**4',5'-Didehydro-5'-deoxy-2'-O-methyluridine**C<sub>11</sub>H<sub>13</sub>NO<sub>5</sub> 239.22

ND138641

5g	\$5000.00
----	-----------

**2',3'-Didehydro-3'-deoxy-thymidine-5'-triphosphate, lithium salt**

ND32048

Price On Application

**2',3'-Didehydro-2',3'-dideoxy-5'-acetate inosine**[130676-57-2] C<sub>12</sub>H<sub>12</sub>N<sub>4</sub>O<sub>4</sub> 276.25

ND76817

25g	\$115.00
50g	\$193.00
100g	\$320.00

**4',5'-Didehydro-2',5'-dideoxy-2'-fluorouridine**C<sub>10</sub>H<sub>10</sub>FNO<sub>4</sub> 227.19

ND138640

5g	\$5000.00
----	-----------



**2',3'-Dideohydro-3'-dideoxy-thymidine-5'-monophosphate, lithium salt**

ND32045

Price On Application

**2',3'-Dideohydro-2'-3'-dideoxythymidine 5'-monophosphate sodium salt**

see Stavudine 5'-monophosphate triethylammonium salt, NS15337 on page 353

**2',3'-Dideohydro-2',3'-dideoxythymidine-5'-monophosphate sodium salt**

see Stavudine 5'-monophosphate sodium salt - 10 mM aqueous solution, NS30745 on page 353

**2',3'-Dideohydro-2'-3'-dideoxythymidine 5'-triphosphate sodium salt**

see Stavudine 5'-triphosphate triethylammonium salt, NS15336 on page 353

**2',3'-Dideohydro-2',3'-dideoxy-thymidine-5'-triphosphate sodium salt**

see Stavudine 5'-triphosphate sodium salt - 10 mM aqueous solution, NS30746 on page 353

**2',3'-Dideohydro-2',3'-dideoxythymidine**

- Stavudine
- Sanilvudine
- Zidovudine Related Compound A

[3056-17-5] C<sub>10</sub>H<sub>12</sub>N<sub>2</sub>O<sub>4</sub> 224.22

ND07118

10g	\$65.00
25g	\$100.00
50g	\$150.00

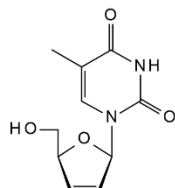

Refs: Cleij MC, et al, L. Labelled Compd. Radiopharm, 2001, 44, p871

**2',3'-Dideohydro-2',3'-dideoxyuridine**[5974-93-6] C<sub>9</sub>H<sub>10</sub>N<sub>2</sub>O<sub>4</sub> 210.19

ND16317

25mg	\$125.00
50mg	\$200.00
100mg	\$300.00

**2',3'-Dideoxyadenosine-5'-monophosphate**

- [(2S,5R)-5-(6-Amino-9H-purin-9-yl)tetrahydro-2-furanyl]methyl dihydrogen phosphate
- 2',3'-Dideoxy-5'-adenylic acid

[26315-55-9] C<sub>10</sub>H<sub>14</sub>N<sub>5</sub>O<sub>5</sub>P 315.22

ND30902

Price On Application

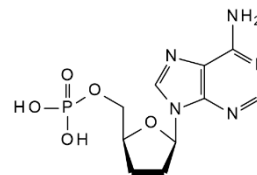
**2',3'-Dideoxyadenosine-5'-monothiophosphate**C<sub>10</sub>H<sub>14</sub>N<sub>5</sub>O<sub>4</sub>PS 331.29

ND10392

1ug	\$105.00
5ug	\$393.80
10ug	\$630.00

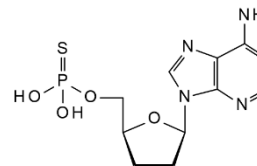
**2',3'-Dideoxyadenosine-5'-triphosphate lithium salt**[93939-70-9] C<sub>10</sub>H<sub>16</sub>N<sub>5</sub>O<sub>11</sub>P<sub>3</sub>·xLi 475.18 (free acid basis)

ND10279

250ug	\$75.00
500ug	\$95.00
1mg	\$150.00

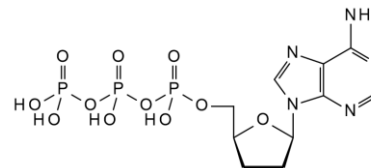

**Dideoxyadeno****2',3'-Dideoxyadenosine-5'-triphosphate lithium salt - 100mM aqueous solution**

• ddATP

[93939-70-9] C<sub>10</sub>H<sub>12</sub>N<sub>5</sub>O<sub>11</sub>P<sub>3</sub>·4Li 498.91

ND32077	0.5mg	\$50.00
	1mg	\$90.00
	2mg	\$160.00

**2',3'-Dideoxyadenosine**[4097-22-7] C<sub>10</sub>H<sub>13</sub>N<sub>5</sub>O<sub>2</sub> 235.25

ND06741	25mg	\$50.00
	50mg	\$80.00
	100mg	\$105.00

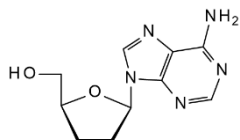

Refs: Cooney DA, Ahluwalia G, Mitsuya H, Fridland A, Johnson M, Hao Z, Dalal M, Balzarini J, Broder S, Johns DG, Biochem. Pharmacol. 1987, Jun 1, 36(11), 1765-8

**2',5'-Dideoxyadenosine**[6698-26-6] C<sub>10</sub>H<sub>13</sub>N<sub>5</sub>O<sub>2</sub> 235.25

ND07997	5mg	\$99.80
	10mg	\$157.50
	25mg	\$289.00

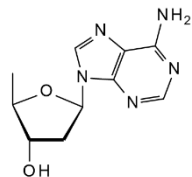
**2',3'-Dideoxy-5'-adenylic acid**

see 2',3'-Dideoxyadenosine-5'-monophosphate, ND30902 on page 239

**2',3'-Dideoxycytidine-5'-triphosphate lithium salt - 100mM aqueous solution**• Zalcitabine triphosphate lithium salt  
• ddCTP[132619-66-0] C<sub>9</sub>H<sub>16</sub>N<sub>3</sub>O<sub>12</sub>P<sub>3</sub> 451.16

ND32066	1mg	\$105.00
	2mg	\$195.00
	5mg	\$375.00

**2',3'-Dideoxycytidine-5'-triphosphate trisodium salt**

• Zalcitabine triphosphate trisodium salt

[66004-77-1] C<sub>9</sub>H<sub>13</sub>N<sub>3</sub>Na<sub>3</sub>O<sub>12</sub>P<sub>3</sub> 517.1

ND10280	1mg	\$350.00
	2mg	\$590.00
	5mg	\$975.00

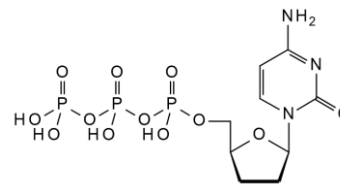
**2',3'-Dideoxycytidine**• Zalcitabine  
• ddC  
• Hivid[7481-89-2] C<sub>9</sub>H<sub>13</sub>N<sub>3</sub>O<sub>3</sub> 211.22

ND06559	200mg	\$50.00
	500mg	\$100.00
	1g	\$180.00

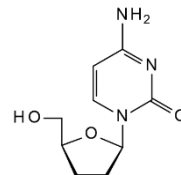

Refs: Yarchoan R, Perno CF, Thomas RV, Klecker RW, Allain JP, Wills RJ, McAtee N, Fischl MA, Dubinsky R, McNeely M, Lancet 1988, Jan 16, 1(8577), p76-81

**2',5'-Dideoxycytidine**C<sub>9</sub>H<sub>13</sub>N<sub>3</sub>O<sub>3</sub> 211.22

ND08405

5mg	\$52.50
10mg	\$94.50
25mg	\$157.50

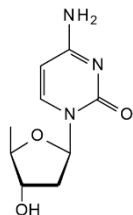
**2',3'-Dideoxy-2',3'-dideoadenosine**

• [(2S,5R)-5-(6-Amino-9H-purin-9-yl)-2,5-dihydrofuran-2-yl]methanol

[7057-48-9] C<sub>10</sub>H<sub>11</sub>N<sub>5</sub>O<sub>2</sub> 233.23

ND05186

100mg	\$85.00
250mg	\$150.00
500mg	\$250.00

**1-(2',3'-Dideoxy-2',3'-dideo-2'-fluoro-5'-O-trityl-b-L-ribofuranosyl)-uracil**C<sub>28</sub>H<sub>23</sub>FN<sub>2</sub>O<sub>4</sub> 470.49

ND58413

25mg	\$153.75
50mg	\$246.00
100mg	\$394.00

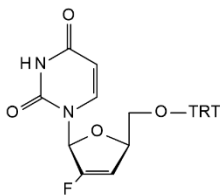
**2',3'-Dideoxy-2',3'-dideoinosine**

[42867-68-5]

ND29820

100mg	\$63.00
250mg	\$105.00
500mg	\$160.00

**2',3'-Dideoxy-5'-O-DMT-cytidine**

• 4-Amino-1-[(2R,5S)-5-[[bis(4-methoxyphenyl)phenylmethoxy]methyl]tetrahydro-2-furanyl]-2(1H)-pyrimidinone

[797804-87-6] C<sub>30</sub>H<sub>31</sub>N<sub>3</sub>O<sub>5</sub> 513.6

ND08403

50mg	\$145.00
100mg	\$240.00
250mg	\$425.00

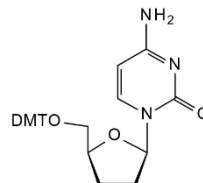
**2',3'-Dideoxy-5'-O-DMT-uridine**C<sub>30</sub>H<sub>30</sub>N<sub>4</sub>O<sub>6</sub> 514.58

ND08411

10mg	\$42.00
25mg	\$79.00
50mg	\$121.00

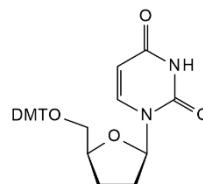
**2',3'-Dideoxy-3'-fluoro-adenosine**[87418-35-7] C<sub>10</sub>H<sub>12</sub>FN<sub>5</sub>O<sub>2</sub> 253.23

ND80474

Price On Application



**Dideoxyfluor****2',3'-Dideoxy-3'-fluorocytidine**

- 1-(2,3-Dideoxy-3-fluoro-b-D-erythro-pentofuranosyl)cytosine
- 2',3'-Dideoxy-3'-fluorocytidine

[51246-79-8] C<sub>9</sub>H<sub>12</sub>FN<sub>3</sub>O<sub>3</sub> 229.21

ND01970	500mg	\$450.00
	1g	\$650.00
	2g	\$950.00

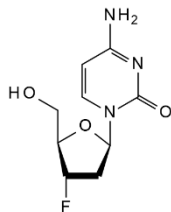
**2',3'-Dideoxy-5-fluorocytidine**[107036-62-4] C<sub>9</sub>H<sub>12</sub>FN<sub>3</sub>O<sub>3</sub> 229.21

ND99344	2mg	\$250.00
	5mg	\$375.00
	10mg	\$550.00

**b-L-2',3'-Dideoxy-5-fluorocytidine**

- 4-Amino-5-fluoro-1-[(2S,5R)-tetrahydro-5-(hydroxymethyl)-2-furanyl]-2(1H)-pyrimidinone

[147058-39-7] C<sub>9</sub>H<sub>12</sub>FN<sub>3</sub>O<sub>3</sub> 229.21

ND157001

Price On Application

**1-(2,3-Dideoxy-3-fluoro-b-D-erythro-pentofuranosyl)cytosine**

see 2',3'-Dideoxy-3'-fluorocytidine, ND01970 on page 242

**1-(2,3-Dideoxy-3-fluoro-a-D-erythro-pentofuranosyl)uracil**

see 2',3'-Dideoxy-3'-fluoro-a-uridine, ND02126 on page 243

**2',3'-Dideoxy-3'-fluoroguanosine**

- 9-(2,3-Deoxy-3-fluoro-b-D-erythro-pentofuranosyl)guanine

[92562-88-4] C<sub>10</sub>H<sub>12</sub>FN<sub>5</sub>O<sub>3</sub> 269.24

ND06059

1mg	\$85.00
2mg	\$150.00
5mg	\$250.00

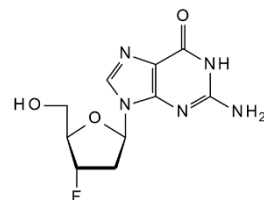
**2',5'-Dideoxy-2'-fluoro-5'-iodouridine**[211694-25-6] C<sub>9</sub>H<sub>10</sub>FIN<sub>2</sub>O<sub>4</sub> 356.09

ND10106

2mg	\$42.00
5mg	\$63.00
10mg	\$94.50

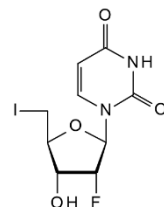
**1-(2,3-Dideoxy-2-fluoropentofuranosyl)cytosine**[119555-47-4] C<sub>9</sub>H<sub>12</sub>FN<sub>3</sub>O<sub>3</sub> 229.21

ND89820

Price On Application

**1-(2,3-Dideoxy-3-fluoro-b-D-ribofuranosyl)uracil**

see 2',3'-Dideoxy-3'-fluorouridine, ND04228 on page 243

**(-)-2',3'-Dideoxy-5-fluoro-3'-thiacytidine**

see Coviracil, NC05645 on page 155

**2',3'-Dideoxy-2'-fluorouridine**[122929-22-0] C<sub>9</sub>H<sub>11</sub>FN<sub>2</sub>O<sub>4</sub> 230.19

ND63201

Price On Application

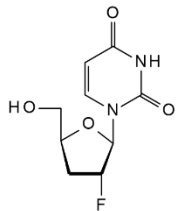
**2',3'-Dideoxy-3'-fluoro-a-uridine**

• 1-(2,3-Dideoxy-3-fluoro-a-D-erythro-pentofuranosyl)uracil

[178374-44-2] C<sub>9</sub>H<sub>11</sub>FN<sub>2</sub>O<sub>4</sub> 230.19

ND02126

1g	\$89.30
2g	\$168.00
5g	\$262.50

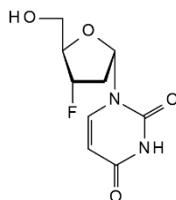
**2',3'-Dideoxy-3'-fluorouridine**

• 1-(2,3-Dideoxy-3-fluoro-b-D-ribofuranosyl)uracil

[41107-56-6] C<sub>9</sub>H<sub>11</sub>FN<sub>2</sub>O<sub>4</sub> 230.2

ND04228

5mg	\$95.00
10mg	\$175.00
25mg	\$350.00

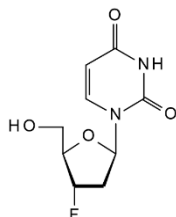

Refs: Mentel R, et.al, Antiviral Research, 1997, 34, p113

**1,(2,3-Dideoxy-b-L-glycero-pentofuranosyl)thymine**

see 3'-Deoxy-L-thymidine, ND02766 on page 222

**2',3'-Dideoxyguanosine-5'-O-(1-thiotriphosphate)**C<sub>10</sub>H<sub>16</sub>N<sub>5</sub>O<sub>11</sub>P<sub>3</sub>S 507.25

ND10393

1ug	\$115.50
5ug	\$367.50
10ug	\$525.00

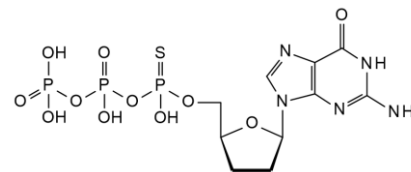
**2',3'-Dideoxyguanosine-5'-triphosphate lithium salt - 100mM aqueous solution**

• dd-GTP

[68726-28-3] C<sub>10</sub>H<sub>16</sub>N<sub>5</sub>O<sub>12</sub>P<sub>3</sub> 491.18

ND32065

Price On Application

**2',3'-Dideoxyguanosine-5'-triphosphate**C<sub>10</sub>H<sub>14</sub>N<sub>5</sub>O<sub>6</sub>P 331.22

ND09987

1ug	\$84.00
5ug	\$210.00
10ug	\$315.00

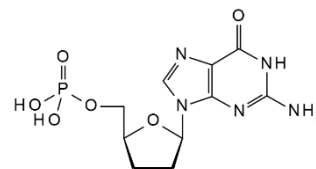
**2',3'-Dideoxyguanosine**

• Dideoxy guanosine

[85326-06-3] C<sub>10</sub>H<sub>13</sub>N<sub>5</sub>O<sub>3</sub> 251.25

ND04069

25mg	\$50.00
50mg	\$75.00
100mg	\$125.00

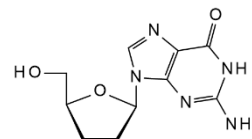

Refs: Aoki-Sei S, O'Brien MC, Ford H, Fujii H, Gilbert DA, Cooney DA, Johns DG, Broder S, Mitsuya H, J. Infect. Dis. 1991, 164(5), p843-51; Johnson, Mol. Pharmacol, 1989, 35, p681; Suzuki et.al, Biochem. Biophys. Res. Comm, 1988, 156, p1144; Walters et.al, J. Pharm. Biomed. Anal, 1999, 19, p955

**Dideoxyguano****2',5'-Dideoxyguanosine**C<sub>10</sub>H<sub>13</sub>N<sub>5</sub>O<sub>3</sub> 251.25

ND08406

Price On Application

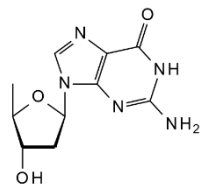
**Dideoxy guanosine**

see 2',3'-Dideoxyguanosine, ND04069 on page 243

**2',3'-Dideoxyinosine-5'-monophosphate sodium salt**

• Didanosine 5'-monophosphate sodium salt

[117947-01-0 (free acid)] C<sub>10</sub>H<sub>11</sub>N<sub>4</sub>O<sub>6</sub>P·Na<sub>2</sub> 360.17

ND28881

Price On Application

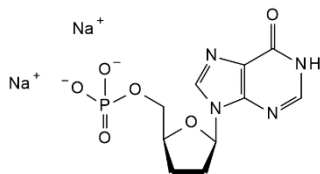
**2',3'-Dideoxyinosine-5'-monophosphate triethylammonium salt**

• Didanosine 5'-monophosphate sodium salt

ND15335

1mg	\$504.00
2mg	\$882.00
5mg	\$1522.50

**2',3'-Dideoxyinosine-5'-triphosphate triethylammonium salt**

• Didanosine 5'-triphosphate sodium salt

[122406-02-4] C<sub>10</sub>H<sub>15</sub>N<sub>4</sub>O<sub>12</sub>P<sub>3</sub> 476.17

ND10277

1mg	\$504.00
2mg	\$882.00
5mg	\$1890.00

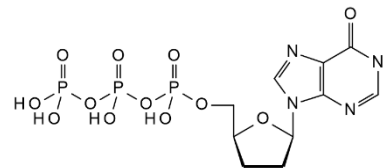
**2',3'-Dideoxyinosine-5'-triphosphate trisodium salt**[137629-34-6][122406-02-4] C<sub>10</sub>H<sub>12</sub>N<sub>4</sub>Na<sub>3</sub>O<sub>12</sub>P<sub>3</sub> 542.11

ND45438

1mg	\$600.00
2mg	\$800.00

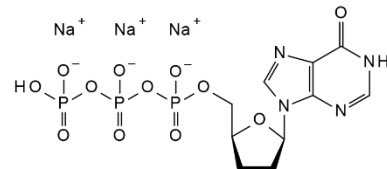
**2',3'-Dideoxyinosine**

- Dideoxyinosine
- Didanosine
- DDI

[69655-05-6] C<sub>10</sub>H<sub>12</sub>N<sub>4</sub>O<sub>3</sub> 236.23

ND02929

5g	\$75.00
10g	\$125.00
25g	\$195.00

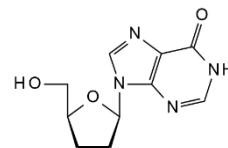

Refs: Dahlbeng, J.E, et al, Proc. Nat. Acad. Sci. USA, 1986, 83, p1911



**2',5'-Dideoxyinosine**

• DIDEOXYINOSINE

C<sub>10</sub>H<sub>12</sub>N<sub>4</sub>O<sub>3</sub> 236.23

ND08407

1mg	\$42.00
5mg	\$84.00
10mg	\$157.50

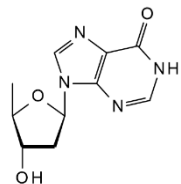
**Dideoxyinosine**

see 2',3'-Dideoxyinosine, ND02929 on page 244

**DIDEOXYINOSINE**

see 2',5'-Dideoxyinosine, ND08407 on page 245

**2',3'-Dideoxy-5-iodocytidine**[114748-57-1] C<sub>9</sub>H<sub>12</sub>N<sub>3</sub>I O<sub>3</sub> 337.11

ND72414

5mg	\$85.00
10mg	\$150.00
25mg	\$250.00

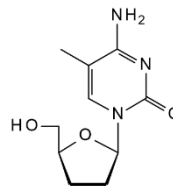
**2'3'-dideoxy-7-iodotubercidin**

see 7-Deaza-2',3'-dideoxy-7-iodoadenosine, ND44800 on page 168

**2',3'-Dideoxy-5-iodouridine**[105784-83-6] C<sub>9</sub>H<sub>11</sub>IN<sub>2</sub>O<sub>4</sub> 338.1

ND07998

2mg	\$75.00
5mg	\$125.00
10mg	\$235.00

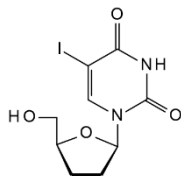
**2',3'-Dideoxy-N2-isobutyrylguanosine**C<sub>14</sub>H<sub>19</sub>N<sub>5</sub>O<sub>4</sub> 321.34

ND08543

25mg	\$157.50
50mg	\$262.50
100mg	\$473.00

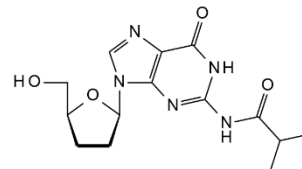
**2',3'-Dideoxy-5-methylcytidine**[107036-56-6] C<sub>10</sub>H<sub>15</sub>N<sub>3</sub>O<sub>3</sub> 225.25

ND08404

10mg	\$84.00
25mg	\$126.00
50mg	\$210.00

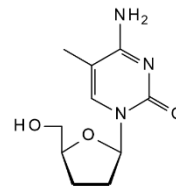
**2',3'-Dideoxy-3'-thia-cytidine-5'-monophosphate**

see Lamivudine 5'-monophosphate ammonium salt, NL24831 on page 302

**2',3'-Dideoxy-3'-thia-cytidine-5'-triphosphate (L isomer), lithium salt**

ND32051	100ug	\$550.00
	250ug	\$1000.00
	500ug	\$1650.00

**2',3'-Dideoxy-3'-thiacytidine**

see Lamivudine, NL06295 on page 302

**Dideoxythioi****2',3'-Dideoxy-6-thio-inosine**

• 6-Thiopurine-2',3'-dideoxyriboside

[126502-10-1] C<sub>10</sub>H<sub>12</sub>N<sub>4</sub>O<sub>2</sub>S 252.29

ND45441

Price On Application

**2',3'-dideoxytubercidin**

see 7-Deaza-2',3'-dideoxyadenosine, ND00041 on page 167

**2',3'-Dideoxyuridine-5'-O-monothiophosphate**C<sub>8</sub>H<sub>13</sub>N<sub>2</sub>O<sub>6</sub>PS 308.25

ND10394

1ug	\$84.00
5ug	\$315.00
10ug	\$525.00

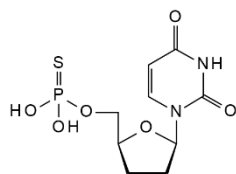
**2',3'-Dideoxyuridine-5'-triphosphate lithium salt - 100mM aqueous solution**

• ddUTP

[84445-38-5] C<sub>9</sub>H<sub>15</sub>N<sub>2</sub>O<sub>13</sub>P<sub>3</sub>·xLi 452.14 (free acid basis)

ND10276

1mg	\$94.50
2mg	\$157.50
4.5mg	\$283.50

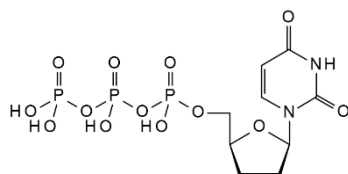
**2',3'-Dideoxyuridine**[5983-09-5] C<sub>9</sub>H<sub>12</sub>N<sub>2</sub>O<sub>4</sub> 212.21

ND06551

50mg	\$84.00
100mg	\$158.00
250mg	\$262.50

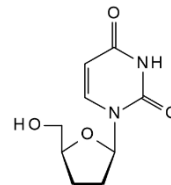

Refs: Hao Z, Cooney DA, Farquhar D, Perno CF, Zhang K, Masood R, Wilson Y, Hartman NR, Balzarini J, Johns DG, Mol. Pharmacol. 1990, Vol37, Issue 2, p157-163

**2',5'-Dideoxyuridine**[35959-50-3] C<sub>9</sub>H<sub>12</sub>N<sub>2</sub>O<sub>4</sub> 212.21

ND08409

1mg	\$36.80
5mg	\$63.00
10mg	\$89.30

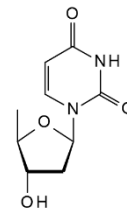
**2',3'-Dideoxyxanthosine**[132194-28-6] C<sub>10</sub>H<sub>12</sub>N<sub>4</sub>O<sub>4</sub> 252.23

ND10205

Price On Application

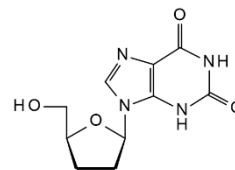
**2',2'-Difluoro-2'-deoxyuridine 3',5'-dibenzoate**

see 3',5'-Di-O-benzoyl-2'-deoxy-2',2'-difluorouridine, ND16691 on page 233

**2',2'-Difluoro-3',5'-dibenzoyl-2'-deoxycytidine**

see 3',5'-Di-O-benzoyl-2'-deoxy-2',2'-difluorocytidine, ND08303 on page 233

**4-(difluoromethyl)-2-hydroxy-pyrimidine-5-carboxylic acid**[1260902-01-9] C<sub>6</sub>H<sub>4</sub>F<sub>2</sub>N<sub>2</sub>O<sub>3</sub> 190.1

ND59458

Price On Application

**2',2'-Difluorothymidine**

see 2'-Deoxy-2',2'-difluoro-5-methyluridine, ND21055 on page 179

**C-di-GMP**

see Cyclic diguanosine monophosphate, NC46014 on page 157

**DIHYDRALAZINE**

see 2,4-Diamino-6,7-dimethylpteridine, ND71063 on page 231

**5,6-Dihydro-5-azacytidine acetate**C<sub>10</sub>H<sub>17</sub>N<sub>4</sub>O<sub>7</sub> 305.26

ND10291

2mg	\$50.00
5mg	\$85.00
10mg	\$134.00

**5,6-Dihydro-2'-deoxy-5-methyluridine**

see 5,6-Dihydrothymidine, ND144870 on page 248

**5,6-Dihydro-2'-deoxyuridine**[5626-99-3] C<sub>9</sub>H<sub>14</sub>N<sub>2</sub>O<sub>5</sub> 230.22

ND07999

5mg	\$75.00
10mg	\$125.00
25mg	\$190.00

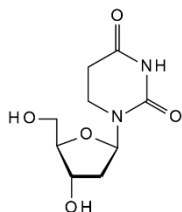
**N-[6,9-Dihydro-9-[(2R,6S)-6-(hydroxymethyl)-2-morpholinyl]-6-oxo-1H-purin-2-yl]-2-methyl-propanamide**

see N2-Isobutyryl-7'-OH-Morpholino guanosine, NI76867 on page 297

**(R)-N-(2,3-Dihydro-1H-indenyl)adenosine**[96392-15-3] C<sub>19</sub>H<sub>21</sub>N<sub>5</sub>O<sub>4</sub> 383.4

ND11705

5mg	\$42.00
10mg	\$63.00
25mg	\$105.00

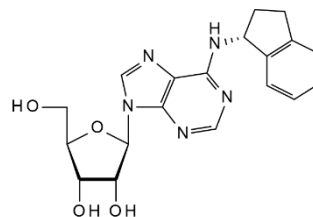
**3,7-Dihydro-5-iodo-4-oxo-4H-pyrrolo[2,3-d]pyrimidine**

• 5-Iodo-3,7-dihydro-pyrrolo[2,3-δ]pyrimidin-4-one

[135352-71-5] C<sub>6</sub>H<sub>4</sub>I<sub>2</sub>N<sub>3</sub>O 261.02

ND57427

100mg	\$82.00
250mg	\$97.50
500mg	\$220.00

**(S)-4,9-Dihydro-a-[(methoxycarbonyl)amino]-4,6-dimethyl-9-oxo-3-b-D-ribofuranosyl-3H-imidazo[1,2-a]purine-7-butanolic acid methyl ester**• Nucleoside Y  
• Wybutosine[55196-46-8] C<sub>21</sub>H<sub>28</sub>N<sub>6</sub>O<sub>9</sub> 508.48

ND157877

Price On Application

**7,8-Dihydro-8-oxo-7-(2-propenyl)guanosine**

see 7-Allyl-7,8-dihydro-8-oxoguanosine, NA07175 on page 32

**Dihydrooxori****3,4-Dihydro-3-oxo-4-b-D-ribofuranosyl-2-pyrazinecarboxamide**

[356782-84-8] C<sub>10</sub>H<sub>13</sub>N<sub>3</sub>O<sub>6</sub> 271.23  
 ND31834 1g \$2000.00

**2,4-Dihydroxy-5,6-dimethylpyrimidine**

[26305-13-5] C<sub>6</sub>H<sub>8</sub>N<sub>2</sub>O<sub>2</sub> 140.14  
 ND44311 1g \$40.00  
 5g \$110.00  
 10g \$160.00

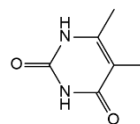
**1,4-Dihydro-4-(b-D-ribofuranosyl)-5H-1,2,3-triazolo[4,5-b]pyridin-5-one**

see 4-(b-D-Ribofuranosyl)-vic-triazolo[4,5-b]pyridin-5-one, NR04971 on page 352

**9-(2,3-Dihydroxy-4-[hydroxymethyl]cyclopentyl)adenine**

see Carbocyclic adenosine, NC29204 on page 135

**5,6-Dihydrothymidine**

• 5,6-Dihydro-2'-deoxy-5-methyluridine

[5627-00-9] C<sub>10</sub>H<sub>16</sub>N<sub>2</sub>O<sub>5</sub> 244.24  
 ND144870 25mg \$215.00  
 50mg \$325.00  
 100mg \$500.00

**9-[(1R,2S,3R,4R)-2,3-Dihydroxy-4-(hydroxymethyl)cyclopentyl]-3H-purin-6-one**

see Carbocyclic inosine, NC29205 on page 136

**Dihydrozeatin riboside-5'-monophosphate sodium salt**

• 6-(4-hydroxy-3-methylbutylamino)-9-b-D-ribofuranosyl purine-5'-monophosphate disodium monohydrate

[31284-94-3] C<sub>15</sub>H<sub>22</sub>N<sub>5</sub>Na<sub>2</sub>O<sub>8</sub>P·H<sub>2</sub>O 495.33  
 ND30226 1mg \$285.00  
 2mg \$420.00  
 5mg \$975.00

**2,6-Dihydro-9-(2',3',5'-tri-O-acetyl-b-D-ribofuranosyl)purine**

C<sub>16</sub>H<sub>22</sub>N<sub>4</sub>O<sub>7</sub> 382.37  
 ND11706 500mg \$105.00  
 1g \$183.80  
 2g \$315.00

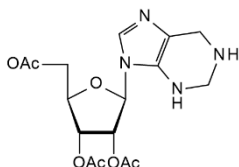
**Dihydrozeatin riboside**

• 6-(4-hydroxy-3-methylbutylamino)-9-b-D-ribofuranosylpurine

[22663-55-4] C<sub>15</sub>H<sub>23</sub>N<sub>5</sub>O<sub>5</sub> 353.37  
 ND30220 10mg \$115.00  
 25mg \$175.00  
 50mg \$225.00

**7-(4,5-cis-Dihydroxy-1-cyclopenten-3-ylaminomethyl)-7-deazaguanosine**

• Queuosine  
 • Nucleoside Q

[57072-36-3] C<sub>17</sub>H<sub>23</sub>N<sub>5</sub>O<sub>7</sub> 409.39  
 ND157876 Price On Application



**4-(Dimethoxymethyl)pyrimidine**

• 4-Pyrimidinecarboxaldehyde, dimethyl acetal

[25746-87-6] C<sub>7</sub>H<sub>10</sub>N<sub>2</sub>O<sub>2</sub> 154.17

ND57369

250mg	\$75.00
500mg	\$120.00
1g	\$290.70

**4,5-Dimethoxy-2-nitrobenzyl adenosine 3',5'-cyclic monophosphate**C<sub>19</sub>H<sub>21</sub>N<sub>6</sub>O<sub>10</sub>P 524.38

ND63885

5mg \$375.00

**5'-O-(4,4'-Dimethoxytrityl)-N6-benzoyl-2'-deoxyadenosine-3'-Icaa-CPG**

• DMT-dA-NBz-Icaa-CPG

ND57353

25g	\$69.50
50g	\$111.00
100g	\$178.00

**5'-O-(4,4'-Dimethoxytrityl)-N4-benzoyl-2'-deoxycytidine-3'-Icaa-CPG**

• DMT-dC-NBz-Icaa-CPG

ND57351

25g	\$69.50
50g	\$111.00
100g	\$178.00

**5'-O-(4,4'-Dimethoxytrityl)-N4-benzoyl-5-methyl-2'-deoxycytidine**

• 5'-DMT-NBz-5-Methyl dC

[104579-03-5] C<sub>38</sub>H<sub>37</sub>N<sub>3</sub>O<sub>7</sub> 647.72

ND57348

2g	\$75.00
5g	\$175.00
10g	\$300.00

**5'-O-(4,4'-Dimethoxytrityl)-3'-O-tert-butyl dimethylsilyl uridine**

see 3'-O-tert-Butyldimethylsilyl-5'-O-DMT-uridine, NB33743 on page 132

**5'-O-(4,4'-dimethoxytrityl)-2'-deoxyadenosine**

• DMT-dA

[17331-22-5] C<sub>31</sub>H<sub>31</sub>N<sub>5</sub>O<sub>5</sub> 553.61

ND57357

500mg	\$60.00
1g	\$116.80
2g	\$186.90

**5'-O-(4,4'-dimethoxytrityl)-2'-deoxycytidine**

• DMT-dC

[76512-82-8] C<sub>30</sub>H<sub>30</sub>N<sub>3</sub>O<sub>6</sub> 528.58

ND57360

250mg	\$50.00
500mg	\$70.00
1g	\$95.00

**5'-O-(4,4'-dimethoxytrityl)-2'-deoxyguanosine**

• 5'-DMT-2'-dG

[81144-43-6] 569.61

ND57359

1g \$95.30



## Dimethoxytri

## 5'-O-(4,4'-Dimethoxytrityl)-2'-deoxyinosine

• DMT-dl

C<sub>31</sub>H<sub>30</sub>N<sub>4</sub>O<sub>6</sub> 554.59

ND47021

1g	\$74.60
2g	\$119.40
5g	\$176.60



## 5'-O-(4,4'-Dimethoxytrityl)-2'-deoxyuridine

see 2'-Deoxy-5'-O-DMT-uridine, ND05965 on page 189

## 5'-O-(Dimethoxytrityl)-N2-(dimethylaminomethylidene)-3'-deoxyguanosine

see 3'-Deoxy-N2-DMF-5'-O-DMT-guanosine, ND31008 on page 181

## 5'-O-(4,4'-Dimethoxytrityl)-N2-isobutyryl-2'-deoxyguanosine-3'-Icaa-CPG

• DMT-dG-NiBu-Icaa-CPG

ND57350

25g	\$69.50
50g	\$111.00
100g	\$178.00



## 5'-O-(4,4'-Dimethoxytrityl)-N4-isobutyryl-2'-O-methylcytidine

see 5'-O-DMT-N4-isobutyryl-2'-O-methylcytidine, ND57358 on page 259

## 5'-O-Dimethoxytrityl-2'-O-methylguanosine

see 5'-O-DMT-2'-O-methylguanosine, ND08420 on page 260

## 5'-O-Dimethoxytrityl-2'-O-methylinosine

see 5'-O-DMT-2'-O-methylinosine, ND08419 on page 260

## 1-5[5-O-(4,4'-Dimethoxytrityl)-3-O-nitrophenylsulphonyl-2-deoxy-b-D-lyxofuranosyl]thymine

see 1-(2'-Deoxy-5'-O-DMT-3'-O-nitrophenylsulphonyl-b-D-lyxofuranosyl)thymine, ND10366 on page 188

## 5'-O-(4,4'-Dimethoxytrityl)-2'-O-(tertbutyldimethylsilyl)-N-benzoyl-Cytidine

see N4-Benzoyl-2'-O-tert-butylidimethylsilyl-5'-O-DMT-cytidine, NB15302 on page 96

## 5'-O-(4,4'-Dimethoxytrityl)-2'-O-(tertbutyldimethylsilyl)-N-isobutyryl-Guanosine

• 2'-O-tert-Butyldimethylsilyl-5'-O-DMT-N2-isobutyrylguanosine

[81279-39-2] C<sub>41</sub>H<sub>51</sub>N<sub>5</sub>O<sub>8</sub>Si 769.96

ND57513

500mg	\$65.00
1g	\$100.00
2g	\$160.00

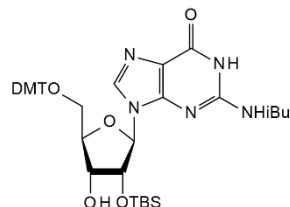

## 5'-O-(4,4'-Dimethoxytrityl)thymidine-3'-Icaa-CPG

• DMT-T-Icaa-CPG

ND57352

25g	\$69.50
50g	\$111.00
100g	\$178.00



## 5'-O-(4,4'-Dimethoxytrityl)-thymidine-3'-O-succinic acid

see 5'-O-DMT-thymidine-3'-O-succinic acid, ND10585 on page 263

## C2,C8-Dimethyladenosine

ND46831

Price On Application



## N6,N6-Dimethyladenosine

see 6-Dimethylamino-9-(b-D-ribofuranosyl)purine, ND04708 on page 251

## N6-(3,3-Dimethylallylamino)purine riboside

see 6-(3,3-Dimethylallylamino)-9-(b-D-ribofuranosyl)purine, ND08001 on page 251

**6-(3,3-dimethylallylamino)-9-β-D-ribofuranosylpurine-5'-monophosphate disodium monohydrate**see *N6-Isopentenyladenosine-5'-monophosphate sodium salt, NI30240 on page 298***6-(3,3-Dimethylallylamino)-9-(β-D-ribofuranosyl)purine**

- N6-(3,3-Dimethylallylamino)purine riboside
- N6-(2-Isopentenyl)adenosine

[7724-76-7] C<sub>15</sub>H<sub>21</sub>N<sub>5</sub>O<sub>4</sub> 335.37

ND08001	50mg	\$48.00
	100mg	\$80.00
	250mg	\$175.00

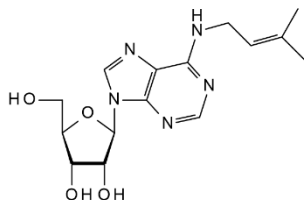
**2-(Dimethylamino)-D-guanosine**see *N2,N2-Dimethylguanosine, ND05647 on page 252***N2-[(Dimethylamino)methylidene]-5'-O-DMT-2'-O-methyl-D-guanosine**see *N2-DMF-5'-O-DMT-2'-O-methylguanosine, ND08425 on page 254***N2-[(dimethylamino)methylidene]-2'-O-methyl-D-guanosine**see *N2-DMF-2'-O-methylguanosine, ND08423 on page 254***2-Dimethylamino-6-oxypurine riboside**see *N2,N2-Dimethylguanosine, ND05647 on page 252***6-Dimethylamino-9-(β-D-ribofuranosyl)purine**

- N6,N6-Dimethyladenosine

[2620-62-4] C<sub>12</sub>H<sub>17</sub>N<sub>5</sub>O<sub>4</sub> 295.3

ND04708	100mg	\$50.00
	250mg	\$80.00
	500mg	\$135.00

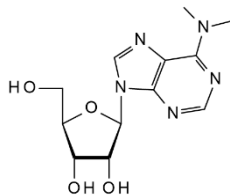

Refs: Elion, G.B, et al, JACS 1952 74, p411-414; Kelley, J.L, et.al, J. Med Chem. 1989, 32, p1020-1024

**3-N-(2,4-Dimethylbenzyl)-1-(5-O-DMT-3-O-nitrophenylsulphonyl)-2-deoxy-β-D-lyxofuranosyl)thymidine**[290371-75-4] C<sub>46</sub>H<sub>45</sub>N<sub>5</sub>O<sub>13</sub>S 879.93

ND11574

5mg	\$90.00
10mg	\$160.00
25mg	\$350.00



Refs: Grierson JR, et.al, Nucl. Med. Biol, 1999, 42, S525

**2'-O-[(1,1-Dimethylethyl)dimethylsilyl]-5'-O-(triphenylmethyl)uridine**see *2'-O-tert-Butyldimethylsilyl-5'-O-trityluridine, NB16515 on page 133***2'-O-[(1,1-Dimethylethyl)dimethylsilyl]-5'-O-(triphenylmethyl)uridine 3'-(O-phenyl carbonothioate)**see *2'-O-(tert-Butyldimethylsilyl)-3'-O-(phenoxythioncarbonyl)-5'-O-trityluridine, NB16514 on page 133***N,N-Dimethyl-guanosine 2',3',5'-triacetate**see *2',3',5'-Tri-O-acetyl-2N,2N-dimethylguanosine, NT16567 on page 371***2',3'-Di-O-methylguanosine**

ND35419

Price On Application

**N2,7-Dimethylguanosine**C<sub>12</sub>O<sub>5</sub>N<sub>5</sub>H<sub>17</sub> 311.29

ND45563

Price On Application



## Dimethylguan

## N2,N2-Dimethylguanosine

- 2-Dimethylamino-6-oxypurine riboside
- 2-(Dimethylamino)-D-guanosine

[2140-67-2] C<sub>12</sub>H<sub>17</sub>N<sub>5</sub>O<sub>5</sub> 311.3

ND05647

5mg	\$65.00
10mg	\$95.00
25mg	\$160.00

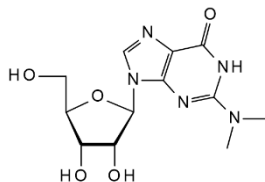

Refs: Topp et.al, Nucleosides, Nucleotides, 1993, 12, p585

## 1,3-Dimethyl-5-[3-(4,4,5,5-tetramethyl-[1,3,2]dioxaborolan-2-yl)-benzylidene]-pyrimidine-2,4,6-trione

ND44285

500mg	\$75.00
1g	\$122.50

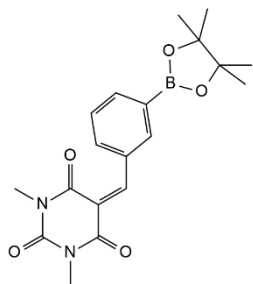

## 1,3-Dimethyl-5-[3-(4,4,5,5-tetramethyl-[1,3,2]dioxaborolan-2-yl)-benzyl]-pyrimidine-2,4,6-trione

ND44286

1g	\$93.50
2g	\$149.60
5g	\$239.30

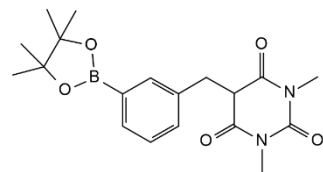

## 1,3-Dimethyl-5-[4-(4,4,5,5-tetramethyl-[1,3,2]dioxaborolan-2-yl)-benzyl]-pyrimidine-2,4,6-trione

ND44283

500mg	\$75.00
1g	\$122.50

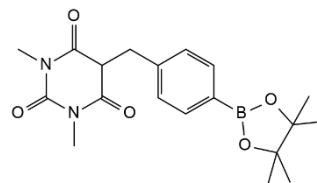

## N-[9-(2,3-Di-O-benzoyl-b-L-ribofuranosyl)-9H-purin-6-yl]-benzamide

see 2',3'-Di-O-benzoyl-N6-benzoyl-L-adenosine, ND145163 on page 232

## 5,6-Dioxyuracil; 2,4,5,6-Tetraoxypyrimidine

see Alloxan tetrahydrate, NA71089 on page 31

## O6-Diphenylcarbonyl-N2-isobutyryl-1-(5'-O-DMT-b-D-arabinofuranosyl)guanine

C<sub>47</sub>H<sub>47</sub>N<sub>5</sub>O<sub>9</sub> 825.9

ND11598

50mg	\$157.50
100mg	\$263.00
250mg	\$472.50

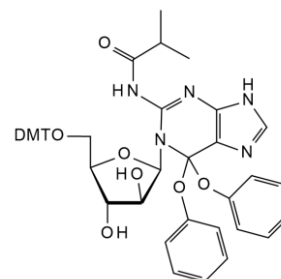



**2',3'-Di(9-phenylxanthen-9-yl)dithiouridine**

• 2',3'-Bis-S-(9-phenyl-9H-xanthen-9-yl)-2',3'-dithio-uridine

[156592-88-0] C<sub>47</sub>H<sub>36</sub>N<sub>2</sub>O<sub>6</sub>S<sub>2</sub> 788.93

ND16531

2mg	\$139.90
5mg	\$254.40
10mg	\$462.50

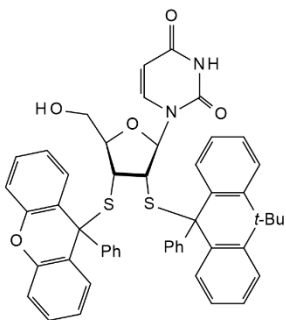
**3',5'-Diphosphoguanosine tetralithium salt**see *b-Guanosine 3',5'-diphosphate tetralithium salt, NG31507* on page 283**Diphosphopyridine nucleotide**see *b-Nicotinamide adenine dinucleotide, NN11969* on page 333**Diphosphopyridine nucleotide**see *b-Nicotinamide adenine dinucleotide sodium salt dihydrate, NN44827* on page 333**(4-N,N-(Dipropyl-1,1-dichloro-2-)aminophenyl)(5'-deoxy-5'-glycylamino-2'-O-tetrahydropyranicytidyl-3')hydrogen phosphate**C<sub>26</sub>H<sub>37</sub>Cl<sub>2</sub>N<sub>6</sub>O<sub>9</sub>P 679.49

ND07075

Price On Application

**(4-N,N-(Dipropyl-1,1-diido-2-)aminophenyl)(5'-deoxy-5'-glycylamino-2'-O-tetrahydropyranicytidyl-3')hydrogen phosphate**

ND01156

Price On Application

**2',3'-Dithiouridine**[156592-92-6] C<sub>9</sub>H<sub>12</sub>N<sub>2</sub>O<sub>4</sub>S<sub>2</sub> 276.33

ND22570

1mg	\$218.10
2mg	\$396.40
5mg	\$720.80

**2,4-Dithiouridine**[13239-96-8] C<sub>9</sub>H<sub>12</sub>N<sub>2</sub>O<sub>4</sub>S<sub>2</sub> 276.33

ND10281

50mg	\$900.00
100mg	\$1200.00
250mg	\$1600.00

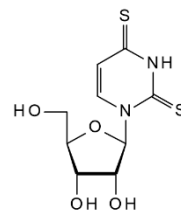

**Ditoluoylchl****3,5-Di-O-toluoyl 6-chloropurine-7-b-D-deoxyribose**

• 6-Chloro-7-[2-deoxy-3,5-bis-O-(4-methylbenzoyl)-b-D-erythro-pentofuranosyl]-7H-purine

[91713-51-8] C<sub>26</sub>H<sub>23</sub>ClN<sub>4</sub>O<sub>5</sub> 506.94

ND16703

10mg	\$149.90
25mg	\$272.50
50mg	\$496.00

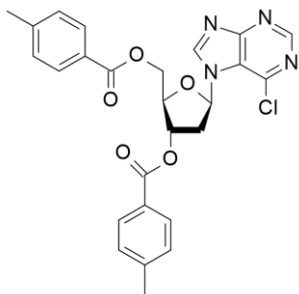
**DM6ATP**

see 2'-Deoxy-N6-methyladenosine 5'-triphosphate sodium salt, ND71654 on page 213

**DMF-dG**

see 2'-Deoxy-N2-DMF-guanosine, ND10841 on page 181

**N2-DMF-5'-O-DMT-2'-O-methylguanosine**

• N2-[(Dimethylamino)methylidene]-5'-O-DMT-2'-O-methyl-D-guanosine

C<sub>35</sub>H<sub>38</sub>N<sub>6</sub>O<sub>7</sub> 643.73

ND08425

100mg	\$90.00
250mg	\$157.50
500mg	\$265.00

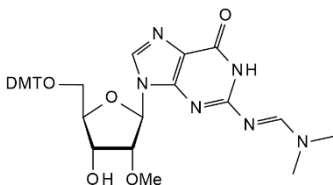
**N2-DMF-guanosine**C<sub>13</sub>H<sub>18</sub>N<sub>6</sub>O<sub>5</sub> 338.32

ND57528

Price On Application

**N2-DMF-2'-O-methylguanosine**

• N2-[(dimethylamino)methylidene]-2'-O-methyl-D-guanosine

C<sub>14</sub>H<sub>20</sub>N<sub>6</sub>O<sub>5</sub> 352.35

ND08423

100mg	\$85.00
250mg	\$150.00
500mg	\$225.00

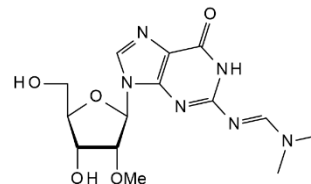
**N2-DMF-2'-O-methylguanosine**C<sub>14</sub>H<sub>20</sub>N<sub>6</sub>O<sub>5</sub> 352.35

ND57532

Price On Application

**DMT-Ac-dA**

see N6-Acetyl-2'-deoxy-5'-O-DMT-adenosine, ND57508 on page 14

**5'-DMT-N4-acetyl-2'-deoxycytidine**

see N4-Acetyl-2'-deoxy-5'-O-DMT-cytidine, NA04015 on page 15

**DMT-Ac-5-I-Cytidine**

see N4-Acetyl-5'-O-DMT-5-iodocytidine, ND57520 on page 18

**DMT-Ac-5-I-2'-deoxycytidine**

see N4-Acetyl-2'-deoxy-5'-O-DMT-5-iodocytidine, ND57519 on page 15

**5'-O-DMT-adenosine**

[81352-25-2]

ND15508

10g	\$200.00
25g	\$400.00
50g	\$600.00

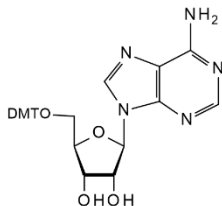
**5'-O-DMT-2,3'-anhydrothymidine**[191474-13-2] C<sub>31</sub>H<sub>30</sub>N<sub>2</sub>O<sub>6</sub> 528.61

ND03508

50mg	\$129.00
100mg	\$221.00
250mg	\$500.00

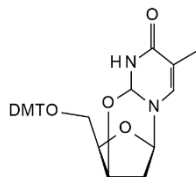

Refs: Machulla HJ, et.al, Radioanl. Nucl. Chem, 2000, 243, p843

**5'-O-DMT-2,2'-anhydrouridine**[207724-65-0] C<sub>30</sub>H<sub>28</sub>N<sub>2</sub>O<sub>7</sub> 528.55

ND63210

5g	\$300.00
10g	\$420.00
25g	\$750.00

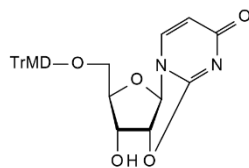
**5'-O-DMT-N6-benzoyl-2'-deoxy-D-adenosine**see *N6-Benzoyl-2'-deoxy-5'-O-DMT-adenosine*, NB02601 on page 100**DMT-dA-NBz-Icaa-CPG**see *5'-O-(4,4'-Dimethoxytrityl)-N6-benzoyl-2'-deoxyadenosine-3'-Icaa-CPG*, ND57353 on page 249**DMT-dA**see *5'-O-(4,4'-dimethoxytrityl)-2'-deoxyadenosine*, ND57357 on page 249**DMT-dC-NBz-Icaa-CPG**see *5'-O-(4,4'-Dimethoxytrityl)-N4-benzoyl-2'-deoxycytidine-3'-Icaa-CPG*, ND57351 on page 249**DMT-dC**see *5'-O-(4,4'-dimethoxytrityl)-2'-deoxycytidine*, ND57360 on page 249**5'-O-DMT-7-deaza-2'-deoxyxanthosine**see *7-Deaza-2'-deoxy-5'-O-DMT-xanthosine*, ND10364 on page 165**DMT-dG-NiBu-Icaa-CPG**see *5'-O-(4,4'-Dimethoxytrityl)-N2-isobutryl-2'-deoxyguanosine-3'-Icaa-CPG*, ND57350 on page 250**DMT-5'-O-dG-3'-O-P(OMe)N(iPr)2**see *2'-Deoxy-5'-O-DMT-guanosine-3'-O-P(OMe)N(iPr)2*, ND02666 on page 185**5'-DMT-2'-dG**see *5'-O-(4,4'-dimethoxytrityl)-2'-deoxyguanosine*, ND57359 on page 249**5'-O-DMT-N-(dimethylamino)methylidene-2'-deoxypseudoisocytidine**[307314-30-3] C<sub>33</sub>H<sub>36</sub>N<sub>4</sub>O<sub>6</sub> 584.66

ND63443

Price On Application

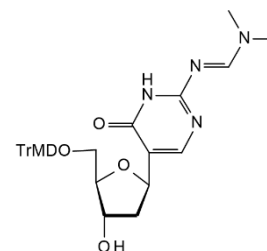

**DMTDimethylf****5'-O-DMT-N2-Dimethylformamid-2'-deoxy-2'-fluoroguanosine**C<sub>34</sub>H<sub>35</sub>N<sub>6</sub>O<sub>6</sub> 642.68

ND46152

50mg	\$50.00
100mg	\$90.00
250mg	\$200.00

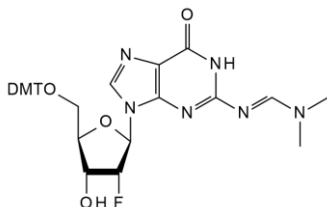
**DMT-dl**

see 5'-O-(4,4'-Dimethoxytrityl)-2'-deoxyinosine, ND47021 on page 250

**5'-O-DMT-N2-DMF-3'-deoxyguanosine**C<sub>34</sub>H<sub>35</sub>N<sub>6</sub>O<sub>6</sub> 624.69

ND11599

Price On Application

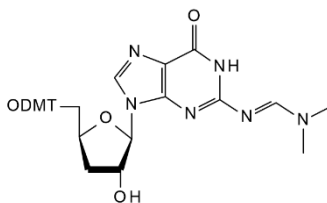
**5'-O-DMT-N2-DMF-guanosine-3'-succinyl CPG 1000 Å**

ND11602

1g \$367.50

**5'-O-DMT-N2-DMF-guanosine**

• 5'-DMT-DMF-rG

[126922-60-9] C<sub>34</sub>H<sub>36</sub>N<sub>6</sub>O<sub>7</sub> 640.69

ND57510

Price On Application

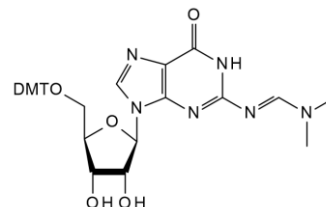
**5'-DMT-DMF-rG**

see 5'-O-DMT-N2-DMF-guanosine, ND57510 on page 256

**5'-O-DMT-dU**

see 2'-Deoxy-5'-O-DMT-uridine, ND05965 on page 189

**5'-O-DMT-N4-ethylcytidine**C<sub>32</sub>H<sub>35</sub>N<sub>3</sub>O<sub>7</sub> 573.64

ND07079

Price On Application

**DMT-2'-F-Bz-dA**

see N6-Benzoyl-2'-deoxy-5'-O-DMT-2'-fluoroadenosine, NB08366 on page 102

**5'-O-DMT-2'-fluoro-2'-deoxyinosine**C<sub>31</sub>H<sub>29</sub>N<sub>4</sub>O<sub>6</sub> 572.58

ND46158

25mg	\$50.00
50mg	\$90.00
100mg	\$150.00



**5'-O-DMT-2'-fluoro-2'-deoxy-D-uridine**

see 2'-Deoxy-5'-O-DMT-2'-fluorouridine, ND06064 on page 184

**5'-O-DMT-guanosine-(dmf) 3'-succinyl CPG 500 Å (RNA)**

ND11626 1g \$367.50

**5'-O-DMT-2'-O-hexylaminoadenosine**

• 2'-O-Hexylamino-5'-O-DMT-adenosine

C<sub>37</sub>H<sub>44</sub>N<sub>6</sub>O<sub>5</sub> 668.8

50mg	\$84.00
100mg	\$158.00
250mg	\$262.50

ND08516

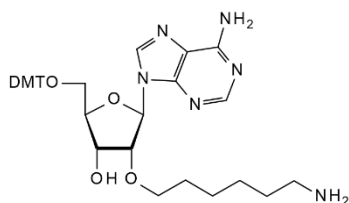
**5'-O-DMT-2'-O-hexylamino-5-methyluridine**

C<sub>37</sub>H<sub>45</sub>N<sub>3</sub>O<sub>8</sub> 659.79

25mg	\$115.50
50mg	\$210.00
100mg	\$315.00

ND08520

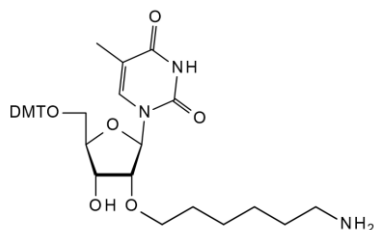
**5'-O-DMT-2'-O-hexylphthalimidocytidine**

C<sub>44</sub>H<sub>46</sub>N<sub>4</sub>O<sub>9</sub> 774.28

2mg	\$42.00
5mg	\$63.00
10mg	\$84.00

ND08414

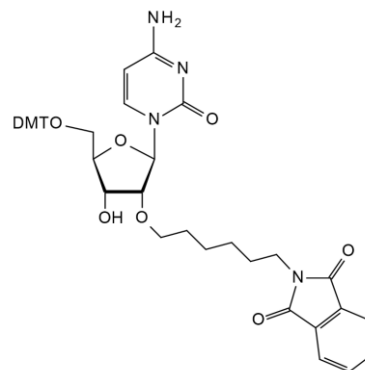
**5'-O-DMT-2'-O-hexylphthalimido-5-methyluridine**

C<sub>45</sub>H<sub>47</sub>N<sub>3</sub>O<sub>10</sub> 789.89

25mg	\$84.00
50mg	\$157.50
100mg	\$263.00

ND08519

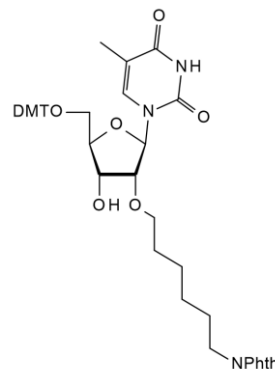

**DMThexylphth****5'-O-DMT-3'-O-hexylphthalimido-5-methyluridine**C<sub>45</sub>H<sub>47</sub>N<sub>5</sub>O<sub>10</sub> 789.89

ND08517

2mg	\$84.00
5mg	\$157.50
10mg	\$262.50

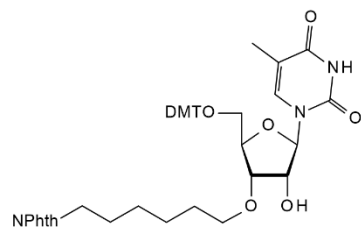
**5'-O-DMT-inosine**

• 5'-DMT-ri

C<sub>31</sub>H<sub>30</sub>N<sub>4</sub>O<sub>7</sub> 570.59

ND57511

Price On Application

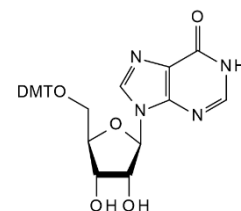

D

**5'-O-DMT-2'-O-hexylphthalimidouridine**C<sub>44</sub>H<sub>45</sub>N<sub>5</sub>O<sub>10</sub> 775.86

ND08415

1mg	\$31.50
5mg	\$63.00
10mg	\$84.00

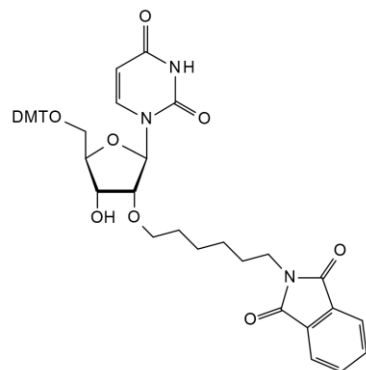
**5'-O-DMT-5-iodouridine**

ND15547

Price On Application

**5'-O-DMT-N2-isobutyryl-9-(b-D-arabinofuranosyl)guanine**C<sub>35</sub>H<sub>37</sub>N<sub>5</sub>O<sub>8</sub> 655.71

ND08422

1mg	\$42.00
2mg	\$63.00
5mg	\$94.50

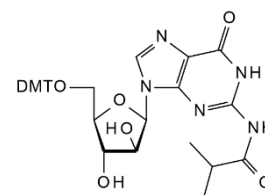
**5'-O-DMT-3'-O-hexylphthalimidouridine**C<sub>44</sub>H<sub>45</sub>N<sub>5</sub>O<sub>10</sub> 775.86

ND08518

10mg	\$84.00
25mg	\$157.50
50mg	\$262.50

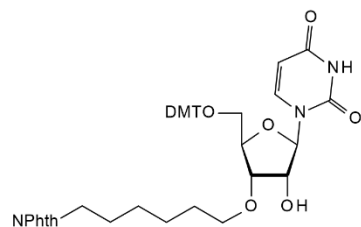

**5'-O-DMT-N2-isobutyrylguanosine**C<sub>38</sub>H<sub>37</sub>N<sub>5</sub>O<sub>8</sub> 655.7

ND10362

2g	\$90.00
5g	\$125.00
10g	\$195.00

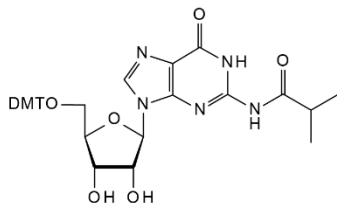
**5'-O-DMT-N2-isobutyryl-2'-O-methylguanosine**

• N2-Isobutyryl-5'-O-DMT-2'-O-methyl-D-guanosine

[114745-26-5] C<sub>38</sub>H<sub>39</sub>N<sub>5</sub>O<sub>8</sub> 669.74

ND03004

500mg	\$60.00
1g	\$105.00
2g	\$190.00

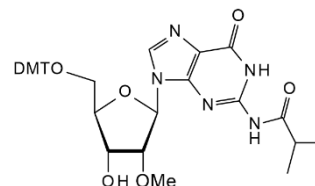
**5'-O-DMT-N2-isobutyryl-2'-O-(2-methoxyethyl)guanosine**

• 5'-O-[Bis(4-methoxyphenyl)phenylmethyl]-2'-O-(2-methoxyethyl)-N-(2-methyl-1-oxopropyl)guanosine

[251647-50-4] C<sub>38</sub>H<sub>43</sub>N<sub>5</sub>O<sub>9</sub> 713.78

ND31620

Price On Application

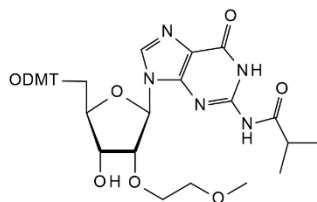
**5'-O-DMT-N4-isobutyryl-2'-O-methyl-5-methylcytidine**C<sub>38</sub>H<sub>41</sub>N<sub>3</sub>O<sub>8</sub> 643.73

ND58235

5g	\$2475.00
10g	\$4500.00
25g	\$7500.00

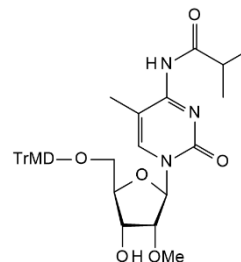
**5'-O-DMT-N4-isobutyryl-2'-O-methylcytidine**• DMT-NiBu-2'-O-methylcytidine  
• 5'-O-(4,4'-Dimethoxytrityl)-N4-isobutyryl-2'-O-methylcytidineC<sub>35</sub>H<sub>39</sub>N<sub>3</sub>O<sub>8</sub> 629.7

ND57358

Price On Application

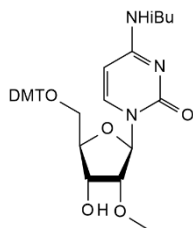
**DMT-T-Icaa-CPG**

see 5'-O-(4,4'-Dimethoxytrityl)thymidine-3'-Icaa-CPG, ND57352 on page 250

**5'-O-DMT-2'-O-(2-methoxyethyl)-5-methyluridine**

• 5'-O-DMT-2'-O-MOE-5-methyluridine

[163759-50-0] C<sub>34</sub>H<sub>38</sub>N<sub>2</sub>O<sub>9</sub> 618.67

ND36302

500mg	\$140.00
1g	\$250.00
2g	\$425.00

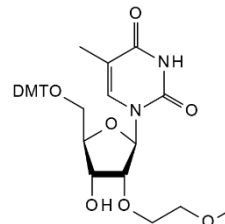

**DMTmethoxyet****5'-O-DMT-2'-O-(2-methoxyethyl)uridine**[251647-51-5] C<sub>33</sub>H<sub>36</sub>N<sub>2</sub>O<sub>9</sub> 604.65

ND76851

Price On Application

**5'-O-DMT-2'-O-methylcytidine**C<sub>31</sub>H<sub>33</sub>N<sub>3</sub>O<sub>7</sub> 559.62

ND08418

500mg	\$45.00
1g	\$75.00
2g	\$140.00

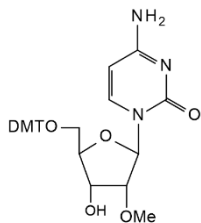
**5'-O-DMT-2'-O-methylguanosine**

- 2'-O-Methyl-5'-O-DMT-D-guanosine
- 5'-O-Dimethoxytrityl-2'-O-methylguanosine

[103285-24-1] C<sub>32</sub>H<sub>33</sub>N<sub>5</sub>O<sub>7</sub> 599.65

ND08420

50mg	\$47.50
100mg	\$90.00
250mg	\$147.50

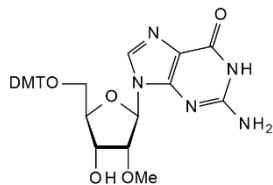
**5'-O-DMT-2'-O-methylinosine**

- 5'-O-Dimethoxytrityl-2'-O-methylinosine

[128219-84-1] C<sub>32</sub>H<sub>32</sub>N<sub>4</sub>O<sub>7</sub> 584.63

ND08419

50mg	\$47.50
100mg	\$74.00
250mg	\$132.50

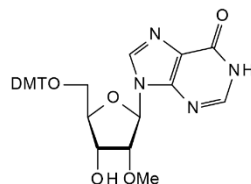
**5'-O-DMT-2'-O-methyl-5-methyluridine**

- 2'-O-Methyl-5'-O-DMT-5-methyluridine

[153631-19-7] C<sub>32</sub>H<sub>34</sub>N<sub>2</sub>O<sub>8</sub> 574.64

ND08567

250mg	\$197.50
500mg	\$315.00
1g	\$472.50

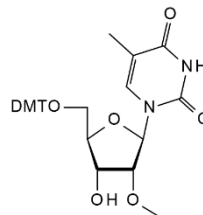
**5'-O-DMT-5-methyl-2'-O-pentyluridine 3'-O succinate triethylammonium salt**C<sub>40</sub>H<sub>45</sub>N<sub>2</sub>O<sub>11</sub>·C<sub>6</sub>H<sub>15</sub>N 832.01

ND08570

50mg	\$118.50
100mg	\$210.00
250mg	\$420.00

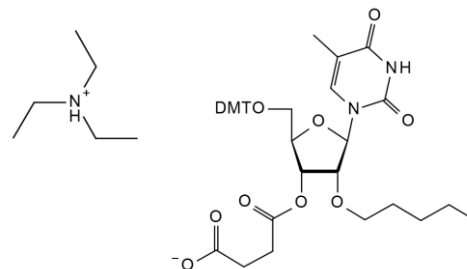



**5'-O-DMT-5-methyl-2'-O-pentyluridine**C<sub>36</sub>H<sub>42</sub>N<sub>2</sub>O<sub>8</sub> 630.74

ND08569

50mg	\$157.50
100mg	\$263.00
250mg	\$472.50

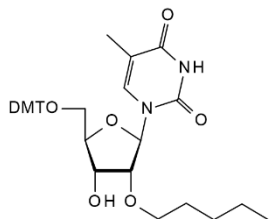
**5'-O-DMT-N6-methyl-N6-phenoxyacetyladenosine 3'-CE phosphoramidite**C<sub>49</sub>H<sub>56</sub>N<sub>7</sub>O<sub>5</sub>P 917.98

ND64692

Price On Application

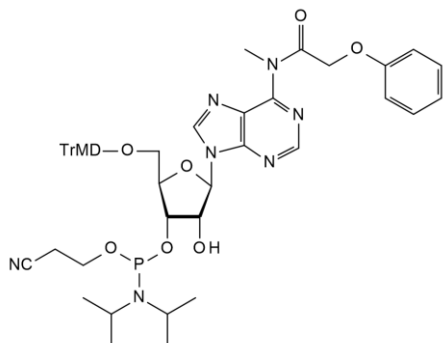
**5'-O-DMT-2'-O-methyl-N6-phenoxyacetyladenosine**[128219-81-8] C<sub>38</sub>H<sub>37</sub>N<sub>5</sub>O<sub>8</sub> 703.76

ND04071

100mg	\$65.00
250mg	\$100.00
500mg	\$160.00

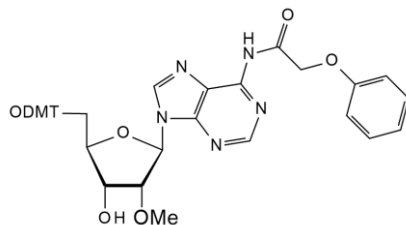
**5'-O-DMT-2'-O-methyl-N6-phenoxyacetyladenosine**

ND145912

100mg	\$50.00
250mg	\$115.00
500mg	\$215.00

**5'-O-DMT-5-methyl-3'-O-propylphthalimidouridine**C<sub>42</sub>H<sub>41</sub>N<sub>3</sub>O<sub>10</sub> 747.81

ND08586

50mg	\$131.50
100mg	\$210.00
250mg	\$420.00

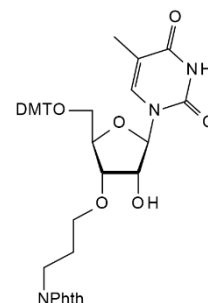
**5'-O-DMT-2'-O-methyluridine**[103285-22-9] C<sub>31</sub>H<sub>32</sub>N<sub>2</sub>O<sub>8</sub> 560.61

ND03001

1g	\$65.00
2g	\$105.00
5g	\$210.00

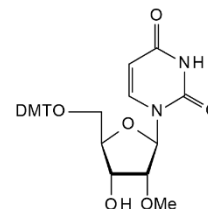
**5'-O-DMT-5-methyluridine**

ND146114

1g	\$50.00
2g	\$92.00
5g	\$210.00



**DMTMOEBz****5'-O-DMT-2'-MOE-C(Bz)**see *N4-Benzoyl-5'-O-DMT-2'-O-(2-methoxyethyl)cytidine*, NB36301 on page 108**DMT-2'-O-MOE-C(Bz)**see *N4-Benzoyl-5'-O-DMT-2'-O-(2-Methoxyethyl)-5-methylcytidine*, NB36300 on page 108**5'-O-DMT-2'-O-MOE-5-methyluridine**see *5'-O-DMT-2'-O-(2-methoxyethyl)-5-methyluridine*, ND36302 on page 259**5'-DMT-NBz-5-Methyl dC**see *5'-O-(4,4'-Dimethoxytrityl)-N4-benzoyl-5-methyl-2'-deoxycytidine*, ND57348 on page 249**DMT-NiBu-2'-O-methylcytidine**see *5'-O-DMT-N4-isobutryl-2'-O-methylcytidine*, ND57358 on page 259**5'-O-DMT-2'-O-pentylaminoadenosine**

• 2'-O-Pentylamino-5'-O-DMT-adenosine

C<sub>26</sub>H<sub>42</sub>N<sub>6</sub>O<sub>6</sub> 654.77

ND08568

250mg	\$210.00
500mg	\$315.00
1g	\$472.50

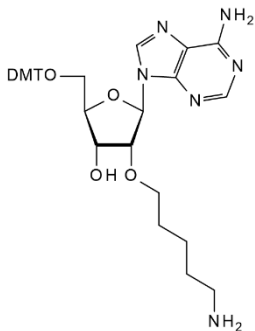
**5'-O-DMT-N2-phenylacetylguanosine**[172965-92-3] C<sub>39</sub>H<sub>37</sub>N<sub>5</sub>O<sub>8</sub> 703.76

ND08925

1g	\$273.00
2g	\$504.00
5g	\$1181.30

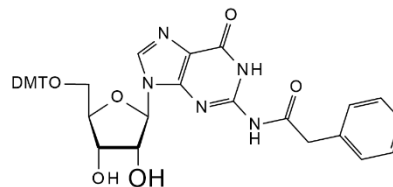
**5'-O-DMT-2'-O-propylphthalimidouridine**C<sub>41</sub>H<sub>39</sub>N<sub>3</sub>O<sub>10</sub> 733.78

ND08421

100mg	\$263.00
250mg	\$552.50
500mg	\$1000.00

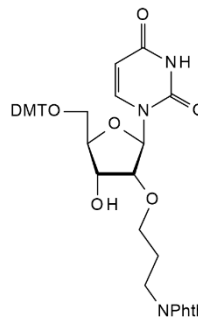
**5'-DMT-rl**see *5'-O-DMT-inosine*, ND57511 on page 258**5'-DMT-3'-TBDMS-N4-Ac-rC**see *N4-Acetyl-3'-O-tert-butylidimethylsilyl-5'-O-DMT-cytidine*, NA15518 on page 12**5'-DMT-3'-TBDMS-Bz-rC**see *N4-Benzoyl-3'-O-tert-butylidimethylsilyl-5'-O-DMT-cytidine*, NB33745 on page 96**5'-DMT-3'-TBDMS-ibu-rG**see *3'-O-tert-Butyldimethylsilyl-5'-O-DMT-N2-isobutrylguanosine*, NB33744 on page 131

**5'-O-DMT-2-thiouridine**C<sub>30</sub>H<sub>30</sub>N<sub>2</sub>O<sub>7</sub>S 562.63

ND29354

Price On Application

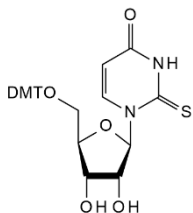
**5'-O-DMT-4-thiouridine**C<sub>30</sub>H<sub>30</sub>N<sub>2</sub>O<sub>7</sub>S 562.64

ND08429

10mg	\$36.80
25mg	\$66.00
50mg	\$118.50

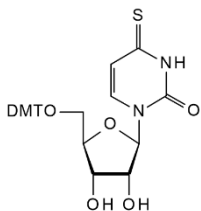
**5-O-DMT-thymidine 3'-H phosphonate triethylammonium salt**C<sub>37</sub>H<sub>48</sub>N<sub>3</sub>O<sub>9</sub>P 709.77

ND11646

250mg	\$105.00
500mg	\$160.00

**5'-O-DMT-thymidine 3'-Q Linker CPG 1000 Å**

ND11611

250mg	\$62.50
500mg	\$100.00
1g	\$157.50

**5'-O-DMT-thymidine 3'-O-succinate triethylammonium salt**[74405-40-6] C<sub>35</sub>H<sub>38</sub>N<sub>2</sub>O<sub>11</sub>·C<sub>6</sub>H<sub>15</sub>N 745.88

ND08490

1g	\$52.00
2g	\$100.00
5g	\$235.00

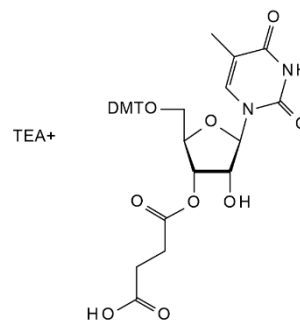
**5'-O-DMT-thymidine 3'-O-succinic acid Pyridinium salt**[1268342-01-3 (free acid)] C<sub>35</sub>H<sub>35</sub>N<sub>2</sub>O<sub>11</sub>·C<sub>5</sub>H<sub>5</sub>N 738.76

ND59759

2g	\$105.30
5g	\$202.50
10g	\$344.00

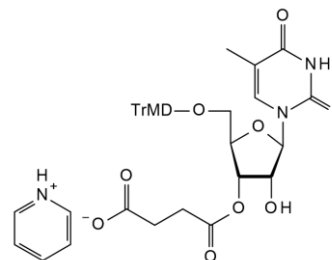
**5'-O-DMT-thymidine-3'-O-succinic acid**

• 5'-O-(4,4'-Dimethoxytrityl)-thymidine-3'-O-succinic acid

[74405-40-6] C<sub>35</sub>H<sub>38</sub>N<sub>2</sub>O<sub>10</sub> 644.67

ND10585

Price On Application

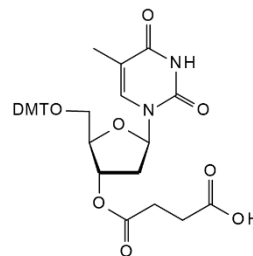

**DMTthymidine****3'-O-DMT-thymidine 3'-succinyl CPG 1000 Å**

ND11618	250mg	\$60.00
	500mg	\$100.00
	1g	\$157.50

**3'-O-DMT-thymidine 3'-succinyl CPG 500 Å**

ND11630	1g	\$157.50
---------	----	----------

**5'-O-DMT-thymidine-3'-succinyl CPG 1400 Å**

ND11604	1g	\$126.00
	5g	\$315.00
	10g	\$525.00

**5'-O-DMT-thymidine-3'-succinyl CPG 2000 Å**

ND11610	1g	\$157.50
	5g	\$472.50
	10g	\$840.00

**5'-O-DMT-thymidine 3'-succinyl CPG 500 Å**

ND11614	500mg	\$85.00
	1g	\$126.00
	2g	\$200.00

**3'-O-DMT-thymidine**C<sub>31</sub>H<sub>32</sub>N<sub>2</sub>O<sub>7</sub> 544.6

ND06918

25mg	\$50.00
50mg	\$85.00
100mg	\$140.00

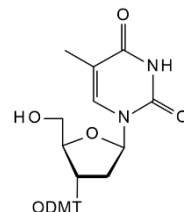
**5'-O-DMT-a-thymidine**

ND146115

100mg	\$50.00
250mg	\$95.00
500mg	\$150.00

**5'-O-DMT-thymidine**[40615-39-2] C<sub>31</sub>H<sub>32</sub>N<sub>2</sub>O<sub>7</sub> 544.6

ND03361

10g	\$40.00
25g	\$75.00
50g	\$140.00

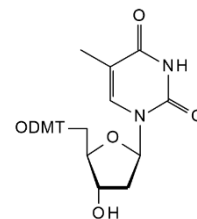

Refs: Abdel-Rahman A A-H, Ali OM, Pedersen EB, Tetrahedron, 1996, 52, 48, p15311

**5'-O-DMT-5-[N-(2-(trifluoroacetamido)ethyl)-3-E-acrylamido]-2'-deoxyuridine**[153512-23-3] C<sub>37</sub>H<sub>37</sub>F<sub>3</sub>N<sub>4</sub>O<sub>8</sub> 738.74

ND08236	50mg	\$89.50
	100mg	\$158.00
	250mg	\$262.50

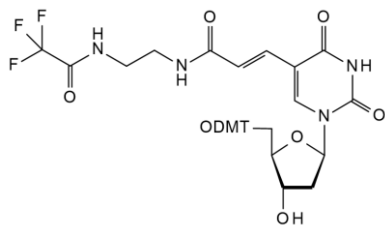
**5'-O-DMT-5-[N-(6-(trifluoroacetamido)hexyl)-3-E-acrylamido]-2'-deoxyuridine**[252337-59-0] C<sub>41</sub>H<sub>45</sub>F<sub>3</sub>N<sub>4</sub>O<sub>8</sub> 794.83

ND08237	50mg	\$89.50
	100mg	\$168.00
	250mg	\$387.50

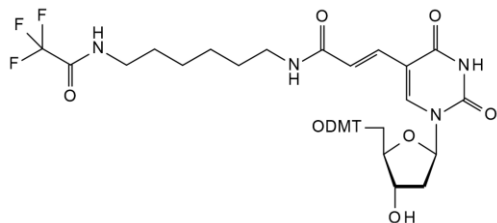
**5'-O-DMT-uridine 3'-succinyl CPG 1000 Å (RNA)**

ND11625	1g	\$367.50
---------	----	----------

**5'-O-DMT-uridine**[81246-79-9] C<sub>30</sub>H<sub>30</sub>N<sub>2</sub>O<sub>8</sub> 546.58

ND08927	5g	\$60.00
	10g	\$100.00
	25g	\$180.00

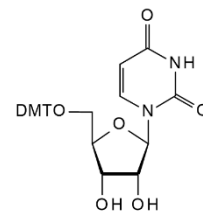
**1-(5'-O-DMT-b-D-xylofuranosyl)thymine**

ND145596

Price On Application

**DNA-Na**

see Deoxyribonucleic acid sodium salt - (Salmon), ND10028 on page 221

**DNA**

see Deoxyribonucleic acid low molecular weight from salmon sperm, ND35412 on page 221

**dNTP bundle - 4 x 100mM aqueous solution**

[1927-31-7][109909-44-6][2564-35-4][3624-46-2]

ND46294	0.8ml	\$64.00
	4ml	\$250.00



**DNTPremixes****dNTP pre-mixes - 10 mmol solution**

[1927-31-7][109909-44-6][2564-35-4][3624-46-2]

ND46295

1ml

\$113.00

**dNTP pre-mixes - 25mM aqueous solution**

[1927-31-7][109909-44-6][2564-35-4][3624-46-2]

ND46296

0.2ml  
1ml\$55.00  
\$220.00**n-Dodecanoyl coenzyme A**see *Lauroyl coenzyme A*, [NL47197 on page 302](#)**Doxifluridine**see *5'-Deoxy-5-fluorouridine*, [ND02968 on page 204](#)**dTDP-a-glc-Na2**see *Thymidine-5'-diphosphate-a-D-glucose disodium salt*, [NT46685 on page 363](#)**dTDP-L-rhamnose**see *Thymidine-5'-diphosphate-L-rhamnose disodium salt*, [NT29845 on page 363](#)**dTTP.Li**see *Thymidine 5'-triphosphate lithium salt - 100mM aqueous solution*, [ND46293 on page 364](#)**5'-DTTP Na3**[27821-54-1] C<sub>10</sub>H<sub>14</sub>N<sub>2</sub>O<sub>14</sub>P<sub>3</sub>Na<sub>3</sub> 548.11

ND02976

Price On Application

**dTTP.Na**see *Thymidine-5'-triphosphate sodium salt - 100mM aqueous solution*, [NT10135 on page 365](#)**dTTP**see *3'-Deoxythymidine-5'-triphosphate lithium salt - 100mM aqueous solution*, [ND32064 on page 222](#)**dUDP.NEt3**see *2'-Deoxyuridine-5'-diphosphate triethylammonium salt - 10 mM aqueous solution*, [ND11202 on page 223](#)**5'-dUMP Na2**see *2'-Deoxyuridine-5'-monophosphate disodium salt*, [ND02992 on page 224](#)**dUpCpp**see *2'-Deoxyuridine-5'-[(a,b)-methylene]triphosphate sodium salt - 10 mM aqueous solution*, [ND45198 on page 224](#)**dUpCp**see *2'-Deoxyuridine-5'-[(a,b)-methylene]diphosphate sodium salt - 10mM aqueous solution*, [ND45197 on page 224](#)**dUpNHpp**see *2'-Deoxyuridine-5'-[(a,b)-imido]triphosphate sodium salt - 10mM aqueous solution*, [ND45196 on page 224](#)**dUpNHp**see *2'-Deoxyuridine-5'-[(a,b)-imido]diphosphate sodium salt - 10mM aqueous solution*, [ND45195 on page 223](#)**5'dUrd, 5-fluoro-5'-deoxyuridine, 5'-DFUR, doxifluridine**see *5'-Deoxy-5-fluorouridine*, [ND02968 on page 204](#)**dUTP sodium salt**see *2'-Deoxyuridine-5'-triphosphate trisodium salt*, [ND08736 on page 224](#)**Edoxudine**see *2'-Deoxy-5-ethyluridine*, [ND08006 on page 190](#)**EFdA**see *2'-Deoxy-4'-ethynyl-2-fluoroadenosine*, [ND45638 on page 190](#)

**Emtricitabine**see *Coviracil*, NC05645 on page 155**Emtricitabine-d2,15N** $C_8H_8D_2FN_2^{15}NO_3S$  250.25

NE153331

Price On Application

**(+)-Emtricitabine**

- 4-Amino-5-fluoro-1-[(2S,5R)-2-(hydroxymethyl)-1,3-oxathiolan-5-yl]-2(1H)-pyrimidinone
- Racivir

[137530-41-7]  $C_8H_{10}FN_3O_3S$  247.25

NE16704

1mg	\$195.00
2mg	\$370.00
5mg	\$825.00

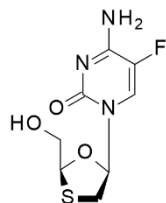
Refs: Mellors, J, et al, *Science*, 72, 1167**Encicitabine**[5726-47-1]  $C_{31}H_{55}N_3O_6$  565.8

NE05152

5mg	\$60.00
10mg	\$90.00
25mg	\$160.00

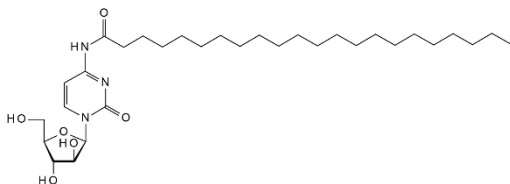
Refs: Aoshima M, et al, *Cancer Res.* 1976, 36, 2726; Akiyama M, et al, *Chem. Pharm. Bull.* 1978, 26, 981**ent-abacavir**

- (1R,4S)-4-[2-Amino-6-(cyclopropylamino)-9H-purin-9-yl]-2-cyclopentene-1-methanol
- (1R-cis)-4-[2-Amino-6-(cyclopropylamino)-9H-purin-9-yl]-2-cyclopentene-1-methanol
- (1R,4S)-Abacavir

[136470-79-6]  $C_{14}H_{18}N_6O$  286.33

NE16540

2mg	\$174.90
5mg	\$318.00
10mg	\$578.20

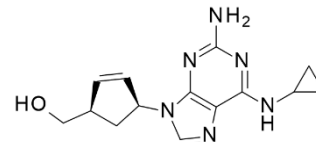
Refs: Hanumegowda, U, et al, *Chem. Res. Toxicol.*, 23, 749 (2010); Prasse, C, et al, *Environ. Sci. Technol.*, 44, 1728 (2010)**Entecavir hydrate**

- 2-Amino-9-[4-hydroxy-3-(hydroxymethyl)-2-methylidene-cyclopentyl]-3H-purin-6-one
- Baraclude

[142217-69-4][209216-23-9]  $C_{12}H_{15}N_5O_3 \cdot xH_2O$  277.28 (anhydrous basis)

NE10532

50mg	\$30.00
100mg	\$50.00
200mg	\$80.00

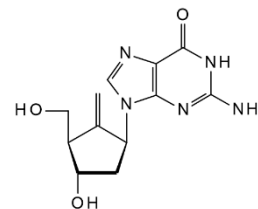
**Entecavir Intermediate IV**

see (1S,2S,3S,5S)-5-(2-Amino-6-(benzyloxy)-9H-purin-9-yl)-3-(benzyloxy)-2-(benzyloxymethyl)cyclopentanol, NA32025 on page 38

**ent-idoxuridine**

- 1-(2-Deoxy-b-L-erythro-pentofuranosyl)-5-iodo-2,4(1H,3H)-pyrimidinedione
- 2'-Deoxy-L-5-iodouridine
- 5-Iodo-2'-deoxy-L-uridine

[162239-35-2]  $C_9H_{11}IN_2O_5$  354.1

NE16541

2mg	\$139.90
5mg	\$254.40
10mg	\$462.50

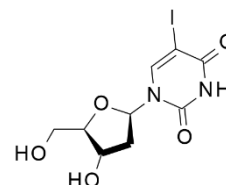
Refs: Chang, C, et al, *J. Biol. Chem.*, 267, 22414 (1992); Pressacco, J, et al, *Cancer Res.*, 54, 3772 (1994)

**EntLamivudin****ent-Lamivudine**

- 4-Amino-1-[(2S,5R)-2-(hydroxymethyl)-1,3-oxathiolan-5-yl]-2(1H)-pyrimidinone
- (2S-cis)-4-Amino-1-[2-(hydroxymethyl)-1,3-oxathiolan-5-yl]-2(1H)-pyrimidinone
- (+)-BCH 189

[134680-32-3] C<sub>8</sub>H<sub>11</sub>N<sub>3</sub>O<sub>3</sub>S 229.26

NE22686

1mg	\$230.00
2mg	\$440.00
5mg	\$950.00

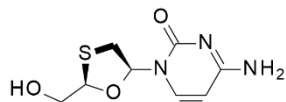

Refs: Pepe, G. et al, Eur. J. Med. Chem, 31, 775 (1996); Marr, E. et al, Antiviral Res, 28, 1 (1995); Parikh, U.M. et al, Antimicrob. Agents Chemother, 49, 1139 (2005)

**3'-epi-5-chloro-2'-deoxyuridine**

- 5-Chloro-1-(2-deoxy-b-D-threo-pentofuranosyl)-2,4(1H,3H)-pyrimidinedione

[188559-94-6] C<sub>9</sub>H<sub>11</sub>ClN<sub>2</sub>O<sub>5</sub> 262.65

NE16712

2mg	\$174.90
5mg	\$318.00
10mg	\$578.20

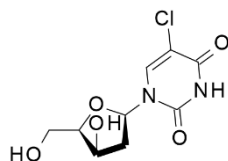

Refs: Brammer, K. et al, Biochim. Biophys. Acta, 72, 217 (1963); Uesugi, S. et al, Chem. Pharm. Bull, 26, 3040 (1978)

**1'-Epi gemcitabine 3',5'-dibenzoate**

- 4-Amino-1-(3,5-di-O-benzoyl-2-deoxy-2,2-difluoro-a-D-erythro-pentofuranosyl)-2(1H)-pyrimidinone

[134790-40-2] C<sub>23</sub>H<sub>19</sub>F<sub>2</sub>N<sub>3</sub>O<sub>6</sub> 471.41

NE16710

5mg	\$109.90
10mg	\$199.90
25mg	\$363.50

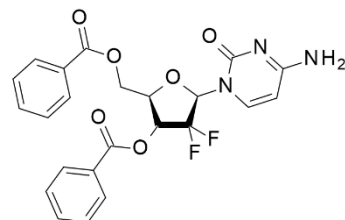

Refs: Hertel, L.W. et al, Cancer Res, 50, 4417 (1990); Abbruzzese, J.L. et al, J. Clin. Oncol, 9, 491 (1991); Ruiz, V.W.T. et al, Biochem. Pharmacol, 46, 762 (1993)

**3'-Epi gemcitabine**

- 4-Amino-1-(deoxy-2,2-difluoro-D-threo-pentofuranosyl)-2(1H)-pyrimidinone
- Gemcitabine impurity

[103882-85-5] C<sub>9</sub>H<sub>11</sub>F<sub>2</sub>N<sub>3</sub>O<sub>4</sub> 263.2

NE22706

1mg	\$825.90
2mg	\$1501.50
5mg	\$2730.00

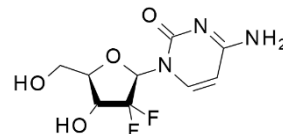

Refs: Hausman, et al, Science, 145, 585 (1964); Prusoff, et al, Biochim. Biophys. Acta, 32, 295 (1959)

**3'-epi-idoxuridine**

- 1-(2-Deoxy-b-D-threo-pentofuranosyl)-5-iodo-2,4(1H,3H)-pyrimidinedione
- 1-(2-Deoxy-b-D-threo-pentofuranosyl)-5-iodouracil

[93780-25-7] C<sub>9</sub>H<sub>11</sub>IN<sub>2</sub>O<sub>5</sub> 354.1

NE16543

2mg	\$139.90
5mg	\$254.40
10mg	\$462.50

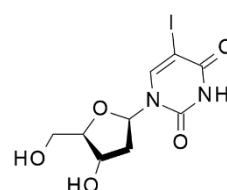

Refs: Chang, C. et al, J. Biol. Chem, 267, 22414 (1992); Pressacco, J. et al, Cancer Res, 54, 3772 (1994)

**2'-Epi-lamivudine**

- 4-Amino-1-[(2S,5S)-2-(hydroxymethyl)-1,3-oxathiolan-5-yl]-2(1H)-pyrimidinone
- (2S-trans)-4-Amino-1-[2-(hydroxymethyl)-1,3-oxathiolan-5-yl]-2(1H)-pyrimidinone
- trans(-)-2-Hydroxymethyl-5-(cytosin-1-yl)-1,3-oxathiolane

[136846-20-3] C<sub>8</sub>H<sub>11</sub>N<sub>3</sub>O<sub>3</sub>S 229.26

NE22731

5mg	\$174.90
10mg	\$318.00
25mg	\$578.50

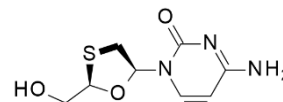

Refs: Lin, T. et al, J. Med. Chem, 39, 1757 (1996); Schinazi, R.F. et al, Antimicrob. Agents Chemother, 36, 672 (1992)



**5'-Epi lamivudine**

- (2R-trans)-4-Amino-1-[2-(hydroxymethyl)-1,3-oxathiolan-5-yl]-2(1H)-pyrimidinone
- 4-Amino-1-[(2R,5R)-2-(hydroxymethyl)-1,3-oxathiolan-5-yl]-2(1H)-pyrimidinone

[139757-68-9] C<sub>9</sub>H<sub>11</sub>N<sub>3</sub>O<sub>3</sub>S 229.26

NE22708	1mg	\$275.00
	2mg	\$500.00
	5mg	\$925.00

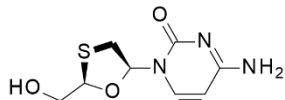

Refs: Chang, C, et al, J. Biol. Chem, 267, 13938 (1992)

**1,N6-Ethenoadenosine-5'-diphosphate, Sodium salt**

- Etheno-ADP

[103213-52-1 (disodium salt)] C<sub>12</sub>H<sub>15</sub>N<sub>5</sub>O<sub>10</sub>P<sub>2</sub> 451.22 (free acid)

NE29590	2mg	\$163.00
	5mg	\$350.00
	10mg	\$598.00

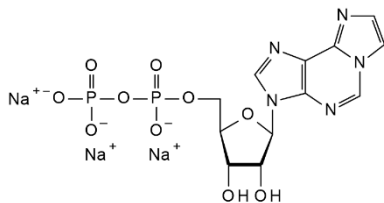
**1,N6-Ethenoadenosine-5'-monophosphate sodium salt**

- Etheno-AMP

[103213-41-8 (monosodium salt)] C<sub>12</sub>H<sub>14</sub>N<sub>5</sub>O<sub>7</sub>P 371.24 (free acid)

NE29589	5mg	\$275.00
	10mg	\$480.00
	25mg	\$1050.00

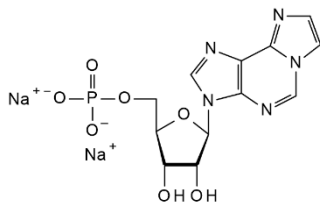
**1,N6-Ethenoadenosine-5'-triphosphate sodium salt - 10mM aqueous solution**[60777-99-3 (disodium salt)] C<sub>12</sub>H<sub>16</sub>N<sub>5</sub>O<sub>13</sub>P<sub>3</sub> 531.20 (free acid) 10mg \$367.50

NE29591

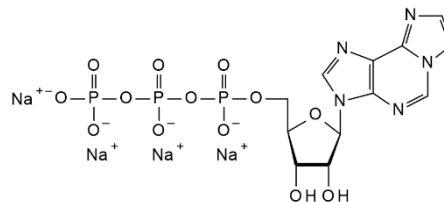
**N6-Ethenoadenosine**[39007-51-7] C<sub>12</sub>H<sub>13</sub>N<sub>5</sub>O<sub>4</sub> 291.26

NE01669	25mg	\$79.00
	50mg	\$144.50
	100mg	\$263.00

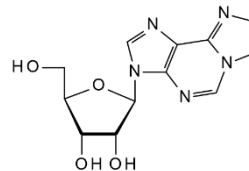

Refs: Nakayama H, Yamaga T, Biophysical Chem, 1998 75, 1, p1

; Srivastava et al, Nucl. Acids Res, 1994, 22, p1296; Miura et al, Anal. Biochem, 1991, 196, p84; Scheller, Sigel, J. Am. Chem, 1983, 105, p3005

**Etheno-ADP**

see 1,N6-Ethenoadenosine-5'-diphosphate, Sodium salt, NE29590 on page 269

**Etheno-AMP**

see 1,N6-Ethenoadenosine-5'-monophosphate sodium salt, NE29589 on page 269

**N4-Ethenocytidine**C<sub>11</sub>H<sub>13</sub>N<sub>3</sub>O<sub>5</sub> 267.24

NE06244	25mg	\$84.00
	50mg	\$136.50
	100mg	\$210.00

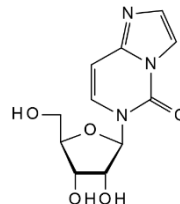

**Ethenodeoxya****N6-Etheno 2'-deoxyadenosine**[68498-25-9] C<sub>12</sub>H<sub>13</sub>N<sub>5</sub>O<sub>3</sub> 275.26

NE06241

5mg	\$63.00
10mg	\$94.50
25mg	\$157.50

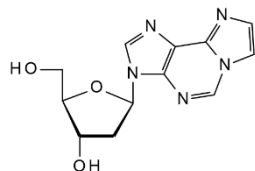

Refs: Srivastava et.al, Nucl. Acids Res, 1994, 22, p1296

**N4-Etheno 2'-deoxycytidine**C<sub>11</sub>H<sub>13</sub>N<sub>3</sub>O<sub>4</sub> 251.24

NE04078

25mg	\$79.00
50mg	\$105.00
100mg	\$158.00

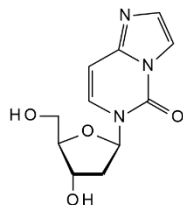
**1,N6-Ethenonicotinamide adenine dinucleotide**

see Nicotinamide 1,N6-ethenoadenine dinucleotide, NN26196 on page 334

**5-(2-Ethoxyphenyl)-1-methyl-3-n-propyl-1,6-dihydro-7H-pyrazolo[4,3-d]pyrimidin-7-one**

- UK 088800
- Imidazosagatriazinone

[139756-21-1] C<sub>17</sub>H<sub>20</sub>N<sub>4</sub>O<sub>2</sub> 312.37

NE16544

500mg	\$130.00
1g	\$227.20
2g	\$413.00

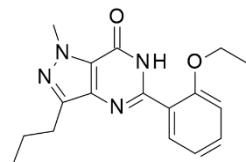
**Ethyl 2-amino-4-methylpyrimidine-5-carboxylate**

[81633-29-6] 181.19

NE57416

2g	\$63.30
5g	\$176.60
10g	\$282.50

**Ethyl 6-amino-2-thioxo-1,2-dihydropyrimidine-5-carboxylate**

NE44318

Price On Application

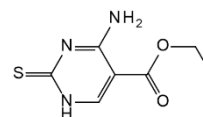
**Ethyl 2-amino-4-(trifluoromethyl)pyrimidine-5-carboxylate**[149771-09-5] C<sub>8</sub>H<sub>8</sub>F<sub>3</sub>N<sub>3</sub>O<sub>2</sub> 235.16

NE57446

2g	\$70.70
5g	\$176.60
10g	\$282.50

**5'-Ethylcarboxamidoadenosine**

- 1-(6-Amino-9H-purin-9-yl)-1-deoxy-N-ethyl-D-ribofuranuronamide
- NECA

[35920-39-9] C<sub>12</sub>H<sub>16</sub>N<sub>6</sub>O<sub>4</sub> 308.29

NE06155

10mg	\$45.00
25mg	\$87.50
50mg	\$160.00

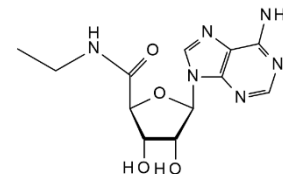

Refs: Cusack, Hounani, Br. J. Pharmacol. 1981, 72, p433; Knapp, et al, Pharmacol. Biochem. Behav. 2001, 68, p797

**5'-Ethylcarboxamido-2-iodoadenosine**

• 2-Iodo-NECA

[141018-29-3] C<sub>12</sub>H<sub>15</sub>N<sub>6</sub>O<sub>4</sub> 434.19

NE06317

1mg	\$80.00
2mg	\$120.00
5mg	\$240.00

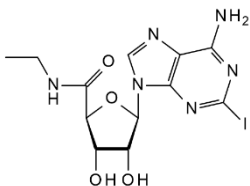

Refs: Reiger JM, et al, J. Med. Chem. 2001, 44, p531

**5'-Ethylcarboxamido-2-iodo-2',3'-O-isopropylideneadenosine**

• 1-(6-Amino-2-iodo-9H-purin-9-yl)-1-deoxy-N-ethyl-2,3-O-(1-methylethylidene)-b-D-ribofuranuronamide

• 2-Iodo-Isopropylidene-NECA

[162936-24-5] C<sub>15</sub>H<sub>19</sub>N<sub>6</sub>O<sub>4</sub> 474.26

NE03797

5mg	\$125.00
10mg	\$230.00
25mg	\$525.00

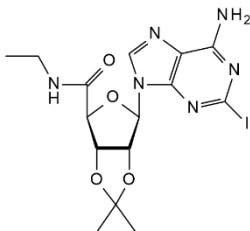
**5'-Ethylcarboxamido-2',3'-O-isopropylideneadenosine**[39491-53-7] C<sub>15</sub>H<sub>20</sub>N<sub>6</sub>O<sub>4</sub> 348.36

NE07208

25mg	\$89.50
50mg	\$168.00
100mg	\$315.00

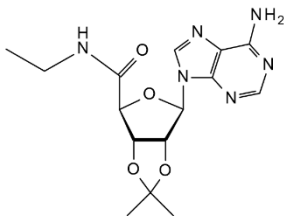
**5-Ethyl-3',5'-bis-(p-chlorobenzoyl)-2'-deoxyuridine**[25137-84-2] C<sub>25</sub>H<sub>22</sub>Cl<sub>2</sub>N<sub>2</sub>O<sub>7</sub> 533.36

NE06039

Price On Application

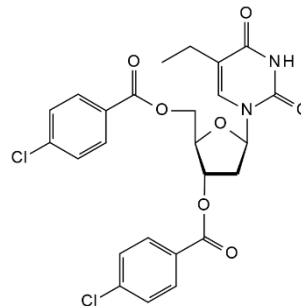
**Ethyl 2-chloro-4-methylpyrimidine-5-carboxylate**

• 2-Chloro-5-(ethoxycarbonyl)-4-methylpyrimidine

[188781-08-0] C<sub>8</sub>H<sub>9</sub>ClN<sub>2</sub>O<sub>2</sub> 200.62

NE57420

50mg	\$79.00
100mg	\$126.00
250mg	\$157.50

**Ethyl 2-chloro-4-(trifluoromethyl)pyrimidine-5-carboxylate**

[187035-79-6] 254.59

NE57448

2g	\$60.00
5g	\$134.80
10g	\$215.60

**Ethyl-2,4-diamino-pyrimidine-5-carboxylate**[15400-54-1] C<sub>7</sub>H<sub>10</sub>N<sub>4</sub>O<sub>2</sub> 182.18

NE57380

250mg	\$70.00
500mg	\$110.00
1g	\$320.80



## Ethylhydroxy

## Ethyl 2-hydroxy-4-(trifluoromethyl)pyrimidine-5-carboxylate

• 2-Hydroxy-4-trifluoromethyl-pyrimidine-5-carboxylic acid ethyl ester

[154934-97-1] 236.15

NE57399

2g	\$60.00
5g	\$111.50
10g	\$178.30



## 2-(Ethylthio)pyrimidine-5-carbaldehyde

[876890-28-7] C<sub>7</sub>H<sub>8</sub>N<sub>2</sub>OS 168.22

NE57431

100mg	\$40.00
250mg	\$72.50
500mg	\$95.00



## 2-O-Ethylthymidine

[59495-21-5] C<sub>12</sub>H<sub>18</sub>N<sub>2</sub>O<sub>5</sub> 270.28

NE07197

100mg	\$90.00
250mg	\$172.50
500mg	\$315.00

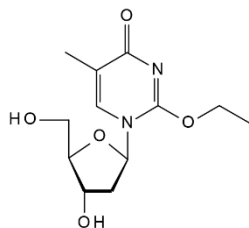

## 5-Ethynyl-2'-deoxyuridine 5'-triphosphate

NE59551

Price On Application



## 5-Ethynyl-2'-deoxyuridine

• 2'-Deoxy-5-ethynyluridine

[61135-33-9] C<sub>11</sub>H<sub>12</sub>N<sub>2</sub>O<sub>5</sub> 252.23

NE08701

100mg	\$65.00
250mg	\$105.00
500mg	\$160.00

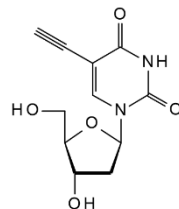

## 5-Ethynyl-2'-O-methyluridine triphosphate

NE63564

Price On Application



## 5-Ethynylpyrimidine

[153286-94-3]

NE44302

Price On Application

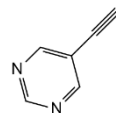

## 5-Ethynyl-1-(β-D-ribofuranosyl)-imidazo-4-carbonitrile

[126004-13-5] C<sub>11</sub>H<sub>11</sub>N<sub>3</sub>O<sub>4</sub> 249.22

NE07194

2mg	\$120.00
5mg	\$218.10
10mg	\$396.50

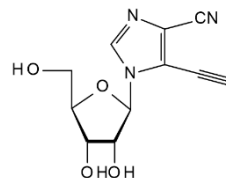

**5-Ethynyluridine-5'-triphosphate sodium salt - 100mM aqueous solution**

[1004955-96-7 (free acid)] C<sub>11</sub>H<sub>15</sub>N<sub>2</sub>O<sub>15</sub>P<sub>3</sub> 508.16 (free acid)  
 1mg \$750.00  
 NE30545 2.5mg \$1225.00  
 5mg \$2100.00

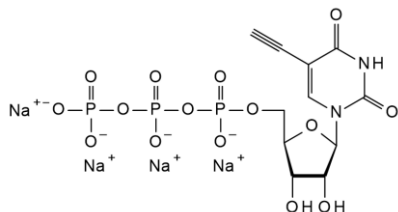
**5-Ethynyluridine**

• 5-EU

[69075-42-9] C<sub>11</sub>H<sub>12</sub>N<sub>2</sub>O<sub>6</sub> 268.22  
 50mg \$42.00  
 NE31862 100mg \$63.00  
 250mg \$105.00

**5-EU**see *5-Ethynyluridine*, NE31862 on page 273**FAD-Na2**see *Riboflavin 5'-adenosine diphosphate disodium salt hydrate*, NR35410 on page 350**2'-FANA-A**see *9-(2'-Deoxy-2'-fluoro-b-D-arabinofuranosyl)adenine*, ND09204 on page 192**2'-FANA-DAP**see *2,6-Diamino-9-(2'-deoxy-2'-fluoro-b-D-arabinofuranosyl)purine*, ND09537 on page 230**2'-FANA-G**see *9-(2'-Deoxy-2'-fluoro-b-D-arabinofuranosyl)guanine*, ND08478 on page 193**2'-FANA-C.HCl**see *1-(2'-Deoxy-2'-fluoro-b-D-arabinofuranosyl)cytosine HCl*, ND08343 on page 193**2'-FANA-I**see *9-(2'-Deoxy-2'-fluoro-b-D-arabinofuranosyl)hypoxanthine*, ND09525 on page 193**2-F-araA**see *Fludarabine*, NF05140 on page 274**2'-F-dATP.Li**see *2'-Deoxy-2'-fluoroadenosine-5'-triphosphate lithium salt - 100mM aqueous solution*, ND46151 on page 191**2'-FdATP.Na**see *2'-Deoxy-2'-fluoroadenosine-5'-triphosphate sodium salt - 100mM aqueous solution*, ND13493 on page 191**2'-FdATP**see *2'-Deoxy-2'-fluoroadenosine-5'-triphosphate*, ND09532 on page 191**2'F-dCTP.Na**see *2'-Deoxy-2'-fluorocytidine-5'-triphosphate sodium salt - 100mM aqueous solution*, ND157276 on page 195**2'F-dGTP.Na**see *2'-Deoxy-2'-fluoroguanosine-5'-triphosphate sodium salt - 100mM aqueous solution*, ND157277 on page 197**5F-dUDP**see *2'-Deoxy-5-fluorouridine 5'-diphosphate sodium salt*, ND31488 on page 203**5F-dUMP**see *2'-Deoxy-5-fluorouridine 5'-monophosphate sodium salt*, ND15883 on page 203**2'-F-dUTP.Li**see *2'-Deoxy-2'-fluorouridine-5'-triphosphate lithium salt - 100mM aqueous solution*, ND46156 on page 203**2'F-dUTP.Na**see *2'-Deoxy-2'-fluorouridine-5'-triphosphate sodium salt - 100mM aqueous solution*, ND157275 on page 203**5F-dUTP**see *2'-Deoxy-5-fluorouridine-5'-triphosphate sodium salt*, ND31483 on page 203

**FialuridineF****Fialuridine (Firu)**[55612-21-0] C<sub>9</sub>H<sub>10</sub>FIN<sub>2</sub>O<sub>5</sub> 372.09

NF65022

25mg	\$75.00
50mg	\$125.00
100mg	\$225.00

**Fialuridine 5'-monophosphate**

- 1-(2-Deoxy-2-fluoro-5-O-phosphono-b-D-arabinofuranosyl)-5-iodo-2,4(1H,3H)-pyrimidinedione

[99891-31-3] C<sub>9</sub>H<sub>11</sub>FIN<sub>2</sub>O<sub>8</sub>P 452.07

NF16547

25mg	\$1375.00
50mg	\$2250.00
100mg	\$3120.00

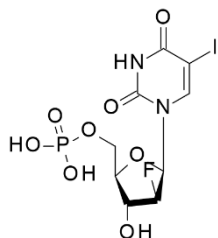

Refs: McLaren, C. et al, Int. Cong. Ser, 667, 57 (1985); Lewis, W. et al, Blochem, 33, 14620 (1994)

**Fialuridine**

see 1-(2'-Deoxy-2'-fluoro-b-D-arabinofuranosyl)-5-iodouracil, ND08477 on page 194

**Fibrinogen - from bovine plasma**

[9001-32-5]

NF32352

1g	\$180.00
2g	\$300.00
5g	\$600.00

**9-(2-Fluoro-2-deoxy-b-D-ribofuranosyl)-hypoxanthine**

see 2'-Deoxy-2'-fluorinosine, ND06005 on page 198

**Flavin adenine dinucleotide disodium salt**

see Riboflavin 5'-adenosine diphosphate disodium salt hydrate, NR35410 on page 350

**Floxuridine**

see 2'-Deoxy-5-fluorouridine, ND02921 on page 204

**Fludarabine phosphate**

- 9-b-D-Arabinofuranosyl-2-fluoroadenine 5-phosphate
- 2-Fluoroadenine arabinoside 5-monophosphate

[75607-67-9] C<sub>10</sub>H<sub>13</sub>FN<sub>5</sub>O<sub>7</sub>P 365.21

NF01485

100mg	\$45.00
250mg	\$75.00
500mg	\$125.00

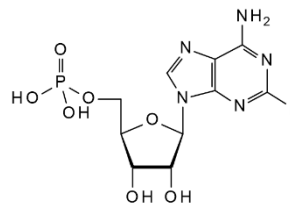
**Fludarabine**

- 2-Fluoro-9-(b-D-arabinofuranosyl)adenine
- 2-F-araA

[21679-14-1] C<sub>10</sub>H<sub>12</sub>FN<sub>5</sub>O<sub>4</sub> 285.23

NF05140

50mg	\$47.50
100mg	\$65.00
250mg	\$100.00

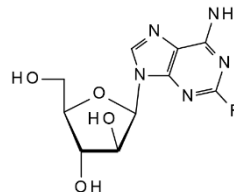

Refs: Keating MJ, Kantarjian H, Talpaz M, Redman J, Kollar C, Barlogie B, Velasquez W, Plunkett W, Freireich EJ, McCredie KB, Blood 74, p19; Brockman RW, et al, Biochem. Pharmacol, 1977, 26, p2193; Chun HG, et al, Cancer Treat. Rep, 1986, 70, p1225

**Fluorescein alkynylamino-ATP - 1.0 mM solution**

• N-[6-[[3-[4-Amino-7-[5-O-[hydroxy[[hydroxy(phosphonoxy)phosphinyl]oxy]phosphinyl]-b-D-ribofuranosyl]-7H-pyrrolo[2,3-d]pyrimidin-5-yl]-2-propynyl]amino]-6-oxohexyl]-3',6'-dihydroxy-3-oxospiro[isobenzofuran-1(3H),9'-[9H]xanthene]-ar-carboxamide

[185971-89-5] C<sub>41</sub>H<sub>41</sub>N<sub>6</sub>O<sub>20</sub>P<sub>3</sub> 1030.71

NF16725

25ug

\$499.00

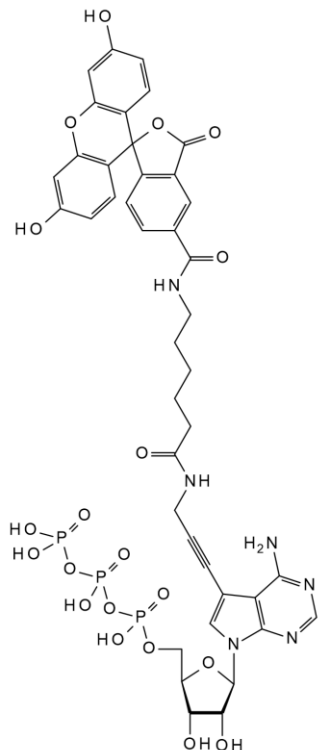

Refs: Igloi, G.L., et al, *BioTechniques*, 21, 1084 (1996)

**Fluorescein-5(6)-carboxamidocaproyl-[5(3-aminoallyl)2-deoxyuridine-5-tr**

NF11636

Price On Application

**Fluorescein-5(6)-carboxamidocaproyl-(5-[3-aminoallyl]uridine 5'-triphosphate) - 1 mM aqueous solution**

• Fluorescein-12-UTP

[134367-01-4] C<sub>39</sub>H<sub>41</sub>N<sub>4</sub>O<sub>22</sub>P<sub>3</sub> 1010.68

NF139015

30ug

\$294.00

**Fluorescein-12-UTP**

see *Fluorescein-5(6)-carboxamidocaproyl-(5-[3-aminoallyl]uridine 5'-triphosphate) - 1 mM aqueous solution, NF139015 on page 275*

**2-Fluoroadenine arabinoside 5-monophosphate**

see *Fludarabine phosphate, NF01485 on page 274*

**4'-C-Fluoroadenosine 5'-sulfamate**

• Nucleocidin

[24751-69-7] C<sub>10</sub>H<sub>13</sub>FN<sub>6</sub>O<sub>6</sub>S 364.31

NF76155

Price On Application

**2-Fluoroadenosine 5'-triphosphate**

• 2-Fluoro-ATP

[1492-62-2] C<sub>10</sub>H<sub>13</sub>FN<sub>5</sub>O<sub>13</sub>P<sub>3</sub> 525.17

NF77069

Price On Application



**Fluoroadenosine****2-Fluoroadenosine**

• 6-Amino-2-fluoro-9-(b-D-ribofuranosyl)purine

[146-78-1] C<sub>10</sub>H<sub>12</sub>FN<sub>5</sub>O<sub>4</sub> 285.23

NF08852

250mg	\$47.50
500mg	\$80.00
1g	\$131.30

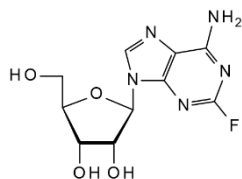
**3'-Fluoroadenosine**

see 3'-Deoxy-3'-fluoroadenosine, ND15616 on page 192

**4'-C-Fluoroadenosine**

[170874-47-2]

NF76129

Price On Application

**8-Fluoroadenosine**[23205-67-6] C<sub>10</sub>H<sub>12</sub>FN<sub>5</sub>O<sub>4</sub> 285.23

NF10198

Price On Application

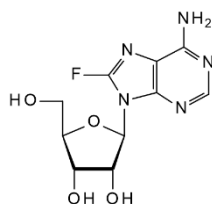
**2-Fluoro-9-(b-D-arabinofuranosyl)adenine**

see Fludarabine, NF05140 on page 274

**2'-Fluoro-arabinofuranosyl-2'-deoxy-uridine**

see 1-(2'-Deoxy-2'-fluoro-b-D-arabinofuranosyl)uracil, ND06062 on page 194

**2-Fluoro-ATP**

see 2-Fluoroadenosine 5'-triphosphate, NF77069 on page 275

**2-Fluoro-cordycepin**

see 3'-Deoxy-2'-fluoroadenosine, ND29524 on page 192

**2'-Fluoro-cyclic-di-guanylate monophosphate sodium salt**[1334145-18-4] C<sub>20</sub>H<sub>20</sub>F<sub>2</sub>N<sub>10</sub>O<sub>12</sub>P<sub>2</sub>·2Na 738.36

NF137619

1mg \$3250.00

**5-Fluorocytidine**[2341-22-2] C<sub>9</sub>H<sub>12</sub>FN<sub>3</sub>O<sub>5</sub> 261.21

NF04135

5g	\$42.00
10g	\$63.00
25g	\$110.50

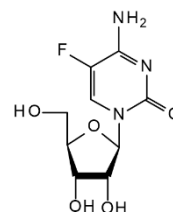

Refs: Yasuyuki N, Masanori M, Hiroyuki E, Hiroshi S, Kaori F, Masako I, Isao U, Katuteru Y, Hideo I, Cancer Science 1990, 81, p188

**2'-Fluoro-dCTP**

see 2'-Deoxy-2'-fluorocytidine-5'-triphosphate tetralithium salt, ND09530 on page 195

**2'-Fluoro-2'-deoxy-D-adenosine**

see 2'-Deoxy-2'-fluoroadenosine, ND02827 on page 192

**2'-Fluoro-2'-deoxy-ATP.4Li**

see 2'-Deoxy-2'-fluoroadenosine-5'-triphosphate tetralithium salt, ND15214 on page 191



**2-Fluoro-9-(2'-deoxy-2'-fluoro-b-D-arabinofuranosyl)adenine**[134217-15-5] C<sub>10</sub>H<sub>11</sub>F<sub>2</sub>N<sub>5</sub>O<sub>3</sub> 287.22

NF11536

Price On Application

**5-Fluoro-1-(2'-deoxy-2'-fluoro-3',5'-di-O-benzoyl-b-L-arabinofuranosyl)-uracil**

[178687-87-1]

NF58423

500mg \$65.00  
1g \$106.68**5-Fluoro-1-(2'-deoxy-2'-fluoro-5'-O-trityl-b-L-lyxofuranosyl)-uracil**

NF58424

25mg \$146.50  
50mg \$234.50  
100mg \$375.00**2'-Fluoro-2'-deoxy-D-guanosine**

see 2'-Deoxy-2'-fluoroguanosine, ND02828 on page 197

**2'-Fluoro-2'-deoxy-D-inosine**

see 2'-Deoxy-2'-fluorinosine, ND06005 on page 198

**9-(2-Fluoro-2-deoxy-b-D-ribofuranosyl)-adenine**

see 2'-Deoxy-2'-fluoroadenosine, ND02827 on page 192

**9-(2-Fluoro-2-deoxy-b-D-ribofuranosyl)-2,6-diaminopurine**

see 2'-Deoxy-2'-fluoroguanosine, ND02828 on page 197

**9-(2-Fluoro-2-deoxy-b-D-ribofuranosyl)-2,6-diaminopurine**

see 2-Amino-2'-deoxy-2'-fluoroadenosine, NA05649 on page 46

**9-(2-Fluoro-2-deoxy-b-D-ribofuranosyl)-guanine**

see 2'-Deoxy-2'-fluoroguanosine, ND02828 on page 197

**1-(2'-Fluoro-2'-deoxy-b-D-ribofuranosyl)uracil**

see 2'-Deoxy-2'-fluorouridine, ND06544 on page 204

**3'-Fluoro-3'-deoxyuridine**[57944-13-5] C<sub>9</sub>H<sub>11</sub>FN<sub>2</sub>O<sub>5</sub> 246.19

NF31830

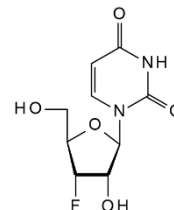
2mg \$120.00  
5mg \$230.00  
10mg \$340.00**5-Fluoro-2'-deoxy-D-uridine**

see 2'-Deoxy-5-fluorouridine, ND02921 on page 204

**5-Fluoro-1-(2',3'-dideoxy-2',3'-didehydro-5'-O-acetyl-b-L-ribofuranosyl)-uracil**[1421336-32-4] C<sub>11</sub>H<sub>12</sub>N<sub>2</sub>O<sub>5</sub> 252.22

NF58421

1g \$95.41

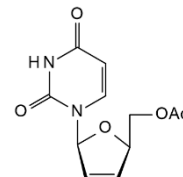

## Fluorodideox

## 5-Fluoro-1-(2',3'-dideoxy-2',3'-dideoxy-b-D-arabinofuranosyl)-cytosine

[134379-77-4] C<sub>9</sub>H<sub>10</sub>FN<sub>3</sub>O<sub>3</sub> 227.19

NF58422

100mg	\$60.00
250mg	\$445.00
500mg	\$710.00

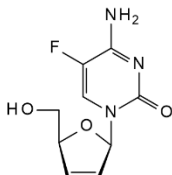

## 2'-Fluoro-5'-O-DMT-N4-acetyl-cytidine

see *N4-Acetyl-2'-deoxy-5'-O-DMT-2'-fluorocytidine*, NA06052 on page 15

## 2'-Fluoro-5'-O-DMT-uridine

see *2'-Deoxy-5'-O-DMT-2'-fluorouridine*, ND06064 on page 184

## 2-Fluoroinosine

- 9-b-D-Arabinofuranosyl-2-fluoro-1,9-dihydro-6H-purin-6-one
- 9-b-D-Arabinofuranosyl-2-fluorohypoxanthine

[83480-48-2] C<sub>10</sub>H<sub>11</sub>FN<sub>4</sub>O<sub>5</sub> 286.22

NF17964

2mg	\$125.00
5mg	\$227.20
10mg	\$413.00

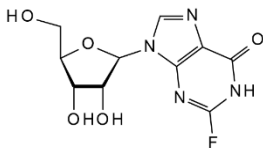

Refs: Struck, R. F., et al,

## 5-Fluoro-6-iodouridine

[87818-06-2] C<sub>9</sub>H<sub>10</sub>FIN<sub>2</sub>O<sub>6</sub> 388.09

NF77568

50mg	\$350.00
100mg	\$500.00
250mg	\$750.00



## 5-Fluoro-2',3'-O-isopropylidencytidine

- 5-Fluoro-1-(2,3-O-isopropylidene-b-D-ribofuranosyl)cytosine

[61787-04-0] C<sub>12</sub>H<sub>16</sub>FN<sub>3</sub>O<sub>5</sub> 301.27

NF04766

25mg	\$89.50
50mg	\$168.00
100mg	\$263.00

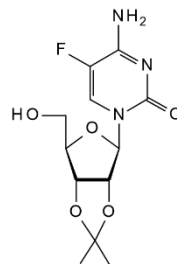

## 5-Fluoro-1-(2,3-O-isopropylidene-b-D-ribofuranosyl)cytosine

see *5-Fluoro-2',3'-O-isopropylidencytidine*, NF04766 on page 278

## 5-Fluoro-1-(2'-L-menthyloxycarbonyl-1'-3'-oxathiolan-5'-yl)-cytosine

[1422361-25-8]

NF58425

50mg	\$90.50
100mg	\$145.00
250mg	\$515.00



## 5-Fluoro-2'-O-methyluridine

[61671-80-5] C<sub>10</sub>H<sub>13</sub>FN<sub>2</sub>O<sub>6</sub> 276.22

NF06416

50mg	\$262.50
100mg	\$447.00
250mg	\$892.50

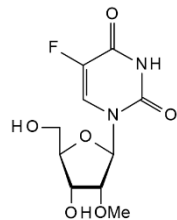

**2-[2-(4-Fluorophenyl)ethoxy]adenosine**

• FPEA

[131865-85-5] C<sub>18</sub>H<sub>20</sub>FN<sub>5</sub>O<sub>5</sub> 405.38

NF16548

50mg	\$140.00
100mg	\$255.00
250mg	\$462.50

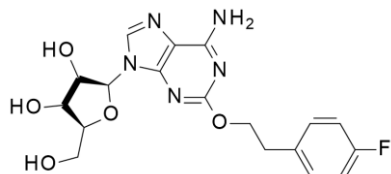

Refs: Matova, M, et al, J. Med. Chem, 32, 505 (1997); Matova, M, et al, Drug Des. Discov, 16, 255 (2000); Adachi, H, et al, J. Med. Chem, 50, 1810 (2007)

**4-(4-Fluorophenyl)pyrimidin-2-amine**

see 2-Amino-4-(4-fluorophenyl)pyrimidine, NA57405 on page 54

**2-(2-Fluorophenyl)pyrimidine-5-carboxaldehyde**

[946707-17-1]

NF44320

Price On Application

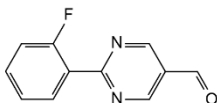
**6-(4-Fluorophenyl)pyrimidine-2,4-diamine**

• 2,4-Diamino-6-(4-fluorophenyl)pyrimidine

[175137-25-4] 204.2

NF57447

1g	\$79.10
2g	\$126.50
5g	\$202.40

**4-(4-Fluorophenyl)-2-pyrimidinethiol**

see 4-(4-Fluorophenyl)pyrimidine-2-thiol, NF57411 on page 279

**4-(4-Fluorophenyl)pyrimidine-2-thiol**

• 4-(4-Fluorophenyl)-2-pyrimidinethiol

[155957-43-0] C<sub>10</sub>H<sub>7</sub>FN<sub>2</sub>S 206.24

NF57411

250mg	\$65.00
500mg	\$105.00
1g	\$218.40

**5-Fluoro-1-(β-L-ribofuranosyl)-uracil**

[77210-26-5]

NF58426

100mg	\$120.00
250mg	\$225.00
500mg	\$375.00

**5'-(4-Fluorosulfonylbenzoyl)adenosine HCl**[78859-42-4] C<sub>17</sub>H<sub>16</sub>FN<sub>5</sub>O<sub>7</sub>S·HCl 489.86

NF08012

2mg	\$90.00
5mg	\$175.00
10mg	\$250.00

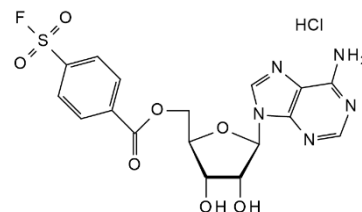
**3'-Fluorothymidine**

see 3'-Deoxy-3'-fluorothymidine, ND02399 on page 202

## Fluorouridin

## 5-Fluorouridine-5'-diphosphate sodium salt

[803-98-5 (free acid)]  $C_9H_{14}FN_2O_{12}P_2$  423.16 10mg \$4725.00  
 NF31489

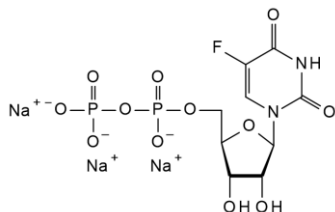

## 5-Fluorouridine-5'-O-b-D-galactopyranoside

[149965-92-4]  $C_{15}H_{21}FN_2O_{11}$  424.33 1mg \$50.00  
 NF04428 2mg \$90.00  
 5mg \$168.00

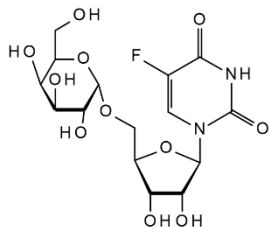

Refs: Watanabe KA, Matsuda A, Halat MJ, Hollenberg DH, Nisselbaum JS, Fox JJ, J. med. Chem, 1981, 24, p893,

## 5-Fluorouridine-5'-monophosphate sodium salt - 10mM aqueous solution

## • 5F-UMP

[796-66-7 (free acid)]  $C_9H_{12}FN_2O_9P$  342.17 500ug \$480.00  
 NF31487 1mg \$810.00

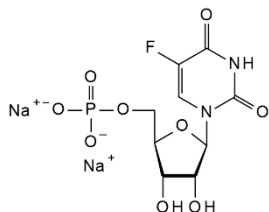

## 5-Fluorouridine-5'-triphosphate sodium salt

[3828-96-4]  $C_9H_{14}N_2O_{15}P_3F$  502.13 1mg \$400.00  
 NF32079 2mg \$600.00  
 5mg \$1250.00



## 5-Fluorouridine-5'-triphosphate triethylammonium salt

NF157285 1mg \$250.00  
 2mg \$350.00  
 5mg \$550.00



## 5-Fluorouridine

## • 1-(b-D-Ribofuranosyl)-5-fluorouracil

[316-46-1]  $C_9H_{11}FN_2O_6$  262.2 5g \$70.00  
 NF04076 10g \$125.00  
 25g \$225.00

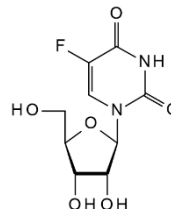

## D-FMAU

see 1-(2-Deoxy-2-fluoro-b-D-arabinofuranosyl)-5-methyluracil, ND11876 on page 194

## N6-Formyl-adenosine

## • N-(9-b-D-Ribofuranosyl-9H-purin-6-yl)-formamide

[6706-56-5]  $C_{11}H_{13}N_5O_5$  295.25 20mg \$3000.00  
 NF146409



**5-Formylcytidine**[148608-53-1] C<sub>10</sub>H<sub>13</sub>N<sub>3</sub>O<sub>6</sub> 271.23

NF63557

1mg	\$85.00
2mg	\$150.00
5mg	\$350.00

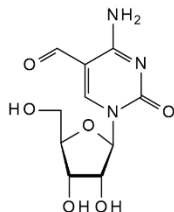
**FPEA**

see 2-[2-(4-Fluorophenyl)ethoxy]adenosine, NF16548 on page 279

**(-)-cis-FTC**see *Coviracil*, NC05645 on page 155**FTRU**

see 2'-Deoxy-2'-fluoro-5-(trimethylstannyl)uridine-epimer, ND03507 on page 202

**5F-UMP**

see 5-Fluorouridine-5'-monophosphate sodium salt - 10mM aqueous solution, NF31487 on page 280

**N6-Furfuryladenosine**see *Kinetin riboside*, NK06717 on page 301**6-Furfurylaminopurine riboside**see *Kinetin riboside*, NK06717 on page 301**6-furfurylamino-9-β-D-ribofuranosylpurine-5'-monophosphate disodium monohydrate**see *Kinetin riboside-5'-monophosphate sodium salt*, NK30244 on page 301**6H-Furo[3,2-f]-1,3,5,2,4-trioxadisilocin, guanosine deriv.**

see 3',5'-O-[Tetrakis(1-methylethyl)-1,3-disiloxanedyl]-guanosine, NT16564 on page 356

**2-(2-Furyl)-5-pyrimidinecarbaldehyde**[959240-19-8] C<sub>9</sub>H<sub>6</sub>N<sub>2</sub>O<sub>2</sub> 174.16

NF57441

1g	\$81.40
2g	\$130.10
5g	\$323.00

**Gemcitabine base**

see 2'-Deoxy-2',2'-difluorocytidine, ND04237 on page 178

**Gemcitabine 5'-elaidate**

- (E)-((2R,3R,5R)-5-(4-Amino-2-oxypyrimidin-1(2H)-yl)-4,4-difluoro-3-hydroxytetrahydrofuran-2-yl)methyl octadec-9-enoate
- 2'-Deoxy-2',2'-difluorocytidine 5'-(9E)-9-octadecenoate
- CP-4126

[210829-30-4] C<sub>27</sub>H<sub>43</sub>F<sub>2</sub>N<sub>3</sub>O<sub>5</sub> 527.66

NC05399

250mg	\$625.00
500mg	\$950.00
1g	\$1500.00

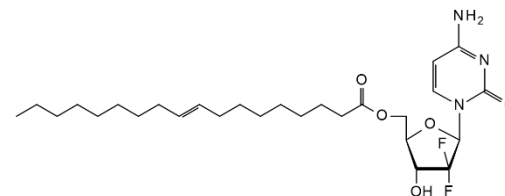
**Gemcitabine HCl**

see 3',5'-Di-O-benzoyl-2'-deoxy-2',2'-difluorocytidine, ND08303 on page 233

**Gemcitabine HCl**

see 2'-Deoxy-2',2'-difluorocytidine hydrochloride, ND09343 on page 178

**Gemcitabine impurity**

see 3'-Epi gemcitabine, NE22706 on page 268

**Gemcitabine 5'-monophosphate triethylammonium salt**

see 2'-Deoxy-2',2'-difluorocytidine 5'-monophosphate triethylammonium salt, ND15970 on page 178

**Gemcitabine-5'-triphosphate triethylammonium salt**

see 2'-Deoxy-2',2'-difluorocytidine 5'-triphosphate triethylammonium salt - Aqueous solution, ND09708 on page 178

**Glucopyranos****6-((E)-4-b-D-glucopyranosyloxy-3-methylbut-2-enylamino)-9-b-D-ribofuranosylpurine**see *trans-Zeatin-o-glucoside riboside*, NZ30326 on page 384**6-((Z)-4-b-D-glucopyranosyloxy-3-methylbut-2-enylamino)-9-b-D-ribofuranosylpurine**see *cis-Zeatin-o-glucoside riboside*, NZ30353 on page 384

G

**5-b-D-Glucopyranosyl-5-thio-thymidine**

NG58692

Price On Application

**5-b-D-Glucopyranosyl-5-thio-thymine**

NG58691

Price On Application

**Glycinamide ribonucleotide**

- 5'-Phosphoribosylglycinamide
- N1-(5-Phospho-D-ribose)glycinamide

[10074-18-7] C<sub>7</sub>H<sub>15</sub>N<sub>2</sub>O<sub>8</sub>P 286.18

NG59700

Price On Application

**GMPCP**see *a,b-Methyleneguanosine 5'-diphosphate sodium salt*, NM46113 on page 316**GMPPCP**see *Guanosine-5'-[(b,gamma)-methylene]triphosphate sodium salt*, NG46689 on page 284**GMPPNP**see *Guanosine-5'-[(b,gamma)-imido]triphosphate sodium salt*, NG35450 on page 284**GMP**see *Guanosine 5'-monophosphate disodium salt*, NG02982 on page 284**GpA**see *Guanylyl-3'-5'-adenosine potassium salt*, NG07985 on page 287**GpC**see *Guanylyl-3'-5'-cytidine ammonium salt*, NG07984 on page 287**GppNHp**see *Guanosine-5'-[(b,gamma)-imido]triphosphate sodium salt*, NG35450 on page 284**GpU**see *Guanylyl-3'-5'-uridine ammonium salt*, NG07983 on page 287**GTP**see *Guanosine 5'-triphosphate sodium salt hydrate*, NG30609 on page 285**Guanine arabinoside**see *9-(b-D-Arabinofuranosyl)guanine*, NA06002 on page 74**Guanine-9-b-D-ribofuranoside**see *Guanosine*, NG06314 on page 286**Guanosine 3',5'-bis(diphosphate) lithium salt - 100mM aqueous solution**

- ppGpp
- Guanosine tetraphosphate

C<sub>10</sub>H<sub>17</sub>N<sub>5</sub>O<sub>17</sub>P<sub>4</sub>·xLi 603.16 (free acid basis)

NG58214

500ug	\$225.00
1mg	\$350.00
2mg	\$620.00

**Guanosine cyclic 2',3'-(hydrogen phosphate) N,N-diethylethanamine**see *Guanosine 2',3'-cyclic phosphate triethylamine salt*, NG16741 on page 283

**Guanosine 2',3'-cyclic monophosphate sodium salt**[15718-49-7] C<sub>10</sub>H<sub>11</sub>N<sub>5</sub>NaO<sub>7</sub>P 367.19

NG145480

10mg	\$135.00
25mg	\$275.00
50mg	\$425.00

**Guanosine 3',5'-cyclic monophosphate sodium salt**

• cyclic GMP

[40732-48-7] C<sub>10</sub>H<sub>11</sub>N<sub>5</sub>NaO<sub>7</sub>P 367.19

NG08975

50mg	\$79.00
100mg	\$132.00
250mg	\$252.50

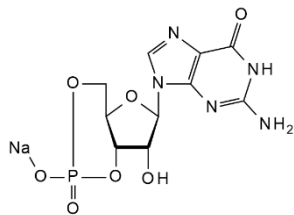
**Guanosine 3',5'-cyclic monophosphate**[7665-99-8] C<sub>10</sub>H<sub>12</sub>N<sub>5</sub>O<sub>7</sub>P 345.21

NG03522

10mg	\$50.00
25mg	\$95.00
50mg	\$150.00

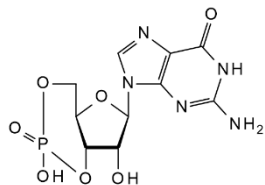
**Guanosine 2',3'-cyclic phosphate triethylamine salt**

• Guanosine cyclic 2',3'-(hydrogen phosphate) N,N-diethylethanamine

[73647-09-3] C<sub>16</sub>H<sub>27</sub>N<sub>6</sub>O<sub>7</sub>P 446.4

NG16741

Price On Application

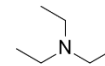
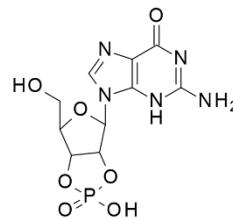

Refs: Heldrick, M.L. et al, Cancer Res, 30, 376 (1970); Vocci, F.J. et al, J. Pharmacol. Exp. Therap, 207, 892 (1978)

**Guanosine 5'-diphosphate disodium salt**[7415-69-2] C<sub>10</sub>H<sub>13</sub>N<sub>5</sub>O<sub>11</sub>P<sub>2</sub>·2Na 487.17

NG09782

2g	\$60.00
5g	\$120.00
10g	\$190.00

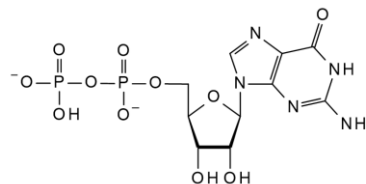
Na<sup>+</sup> Na<sup>+</sup>**Guanosine 5'-diphosphate sodium salt**[43139-22-6][7415-69-2] C<sub>10</sub>H<sub>15</sub>N<sub>5</sub>O<sub>11</sub>P<sub>2</sub>·xNa 443.2 (free acid)

NG08963

50mg	\$75.00
100mg	\$115.00
250mg	\$185.00

**Guanosine 3',5'-diphosphate tetralithium salt**

• 3',5'-Diphosphoguanosine tetralithium salt

[32452-17-8][55612-39-0][3237-37-4] C<sub>10</sub>H<sub>11</sub>Li<sub>4</sub>N<sub>5</sub>O<sub>11</sub>P<sub>2</sub> 466.93

NG31507

50mg \$2500.00



**Guanosinehyd****Guanosine hydrate**see *Guanosine*, NG06314 on page 286**Guanosine-5'-[(b,gamma)-imido]triphosphate sodium salt**

- GMPPNP
- GppNHp

[148892-91-5]	C <sub>10</sub> H <sub>17</sub> N <sub>6</sub> O <sub>13</sub> P <sub>3</sub> ·xNa	522.20 (free acid basis)	
		5mg	\$131.30
		10mg	\$199.50
		25mg	\$394.00

NG35450

**Guanosine-5'-[(b,gamma)-methylene]triphosphate sodium salt**

- GMPPCP

[13912-93-1]	C <sub>11</sub> H <sub>18</sub> N <sub>6</sub> O <sub>13</sub> P <sub>3</sub> ·xNa	521.21 (free acid basis)	
		5mg	\$90.00
		10mg	\$150.00
		25mg	\$225.00

NG46689

**Guanosine 5'-monophosphate calcium salt**

- Calcium 5'-guanylate
- Guanylic acid calcium salt

[38966-30-2] C<sub>10</sub>H<sub>12</sub>CaN<sub>5</sub>O<sub>8</sub>P 401.28

Price On Application

NG40772

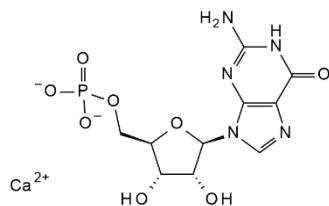
**Guanosine 2'-3'-monophosphate disodium salt mixed isomers**see *Guanosine-2'(&3')-monophosphate disodium salt (mixed isomers)*, NG57356 on page 286**Guanosine 5'-monophosphate disodium salt**

- 5'-Guanylic Acid
- GMP

[5550-12-9] C<sub>10</sub>H<sub>12</sub>N<sub>5</sub>O<sub>8</sub>P·2Na 407.18

NG02982

250g	\$60.00
500g	\$115.00
1kg	\$220.00

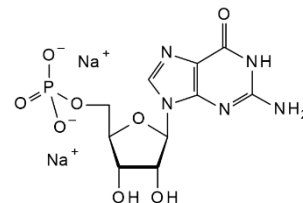
**Guanosine 5'-monophosphate disodium salt [1',2',3',4',5'-13C5]**13C<sub>5</sub>C<sub>8</sub>H<sub>12</sub>N<sub>5</sub>O<sub>8</sub>P·2Na 412.64

NG57598

10mg \$2200.00

**Guanosine-5'-monophosphate triethylammonium salt**

NG30910

Price On Application

**Guanosine 5'-monophosphate**[85-32-5] C<sub>10</sub>H<sub>14</sub>N<sub>5</sub>O<sub>8</sub>P 363.22

NG09355

10g	\$50.00
25g	\$95.00
50g	\$175.00

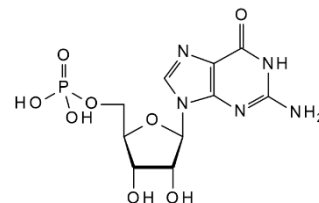



**Guanosine 5'-(tetrahydrogen triphosphate) P<sup>3</sup>-[1-(2-nitrophenyl)ethyl]ester**see *Caged GTP, NC19632 on page 134***Guanosine tetraphosphate**see *Guanosine 3',5'-bis(diphosphate lithium salt - 100mM aqueous solution, NG58214 on page 282***Guanosine 5'-O-(2-thiodiphosphate) trilithium salt**[97952-36-8][71783-24-9] C<sub>10</sub>H<sub>12</sub>N<sub>5</sub>O<sub>10</sub>P<sub>2</sub>S·3Li 477.06

NG09615	1mg	\$75.00
	2mg	\$110.00
	5mg	\$175.00

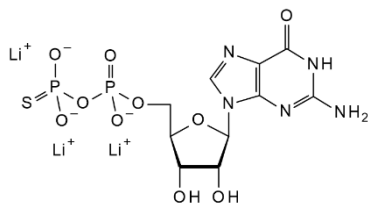
**Guanosine 5'-O-(1-thiotriphosphate) lithium salt - 100mM aqueous solution**

• a-Thio-GTP

[81570-50-5] C<sub>10</sub>H<sub>16</sub>N<sub>5</sub>O<sub>13</sub>P<sub>3</sub>S·4Li 567.01

NG58207	1mg	\$125.00
	2mg	\$200.00
	5mg	\$350.00

**Guanosine Triacetate**see *2',3',5'-Tri-O-acetylguanosine, NT06136 on page 371***Guanosine 5'-triphosphate disodium salt**[56001-37-7] C<sub>10</sub>H<sub>14</sub>N<sub>5</sub>O<sub>14</sub>P<sub>3</sub>Na<sub>2</sub> 567.14

NG01208	1g	\$50.00
	2g	\$90.00
	5g	\$195.00

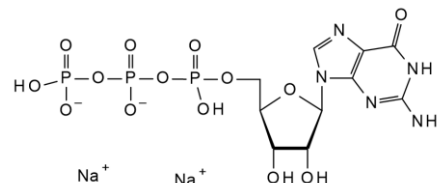
**Guanosine 5'-triphosphate P3-[1-(2-nitrophenyl)ethyl]ester**see *Caged GTP, NC19632 on page 134***Guanosine 5'-triphosphate sodium salt hydrate**

- GTP
- Guanosine 5'-triphosphate trisodium salt

[36051-31-7] C<sub>10</sub>H<sub>16</sub>N<sub>5</sub>O<sub>14</sub>P<sub>3</sub>·xNa 523.18 (free acid basis)

NG30609	25mg	\$90.00
	50mg	\$150.00
	100mg	\$250.00

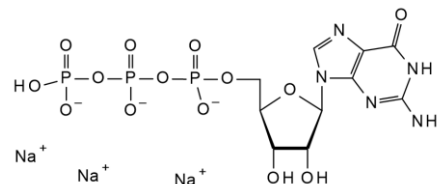
**Guanosine 5'-triphosphate trisodium salt**see *Guanosine 5'-triphosphate sodium salt hydrate, NG30609 on page 285***Guanosine 5'-triphosphate**[86-01-1] C<sub>10</sub>H<sub>16</sub>N<sub>5</sub>O<sub>14</sub>P<sub>3</sub> 523.18

NG03984

Price On Application

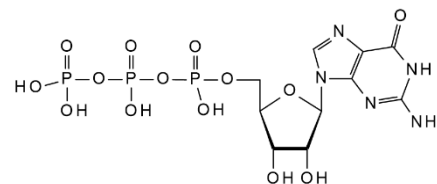

**Guanosine****Guanosine**

- 9-(β-D-Ribofuranosyl)guanine
- Guanine-9-β-D-ribofuranoside
- Guanosine hydrate

[118-00-3] C<sub>10</sub>H<sub>13</sub>N<sub>5</sub>O<sub>5</sub>·H<sub>2</sub>O 301.26

	250g	\$50.00
NG06314	500g	\$70.00
	1kg	\$115.00

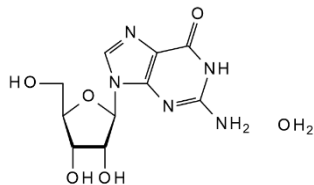

Refs: Pao CC, Palletta J, Gallant JA, Biochem. Biophys. Res. Commun. 1977, Jan 10, 74(1), 314-22

**Guanosine-2'(&3')-monophosphate disodium salt (mixed isomers)**

- Guanylic acid disodium salt
- Guanosine 2'-3'-monophosphate disodium salt mixed Isomers

[6027-83-4] C<sub>10</sub>H<sub>12</sub>N<sub>5</sub>O<sub>6</sub>PNa<sub>2</sub> 407.18

	250mg	\$60.00
NG57356		

**Guanosine 5'-[γ-thio]triphosphate tetralithium salt**[94825-44-2] C<sub>10</sub>H<sub>12</sub>Li<sub>4</sub>N<sub>5</sub>O<sub>13</sub>P<sub>3</sub>S 562.98

NG63193

Price On Application

**L-Guanosine**

- 9-(β-L-Ribofuranosyl)guanine

[26578-09-6] C<sub>10</sub>H<sub>13</sub>N<sub>5</sub>O<sub>5</sub> 283.24

	10mg	\$157.50
NG05944	25mg	\$210.00
	50mg	\$315.00

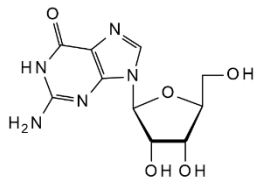

Refs: Joyce GF, Schwartz AW, Miller SL, Orgel LE, Proc. Natl. Acad. Sci. 1987, Vol84, No13, 4398-44

**Guanylic acid calcium salt**see *Guanosine 5'-monophosphate calcium salt, NG40772 on page 284***Guanylic acid disodium salt**see *Guanosine-2'(&3')-monophosphate disodium salt (mixed isomers), NG57356 on page 286***[2'-18O]Guanosine**

- 9-(β-D-[2-18O]Ribofuranosyl)guanine

C<sub>10</sub>H<sub>13</sub>N<sub>5</sub><sup>18</sup>O<sub>4</sub> 285.24

NG106386

Price On Application

**5'-Guanylic Acid**see *Guanosine 5'-monophosphate disodium salt, NG02982 on page 284*

**Guanylyl-3'-5'-adenosine potassium salt**

• GpA

[103192-47-8][6918-37-2] C<sub>20</sub>H<sub>25</sub>N<sub>10</sub>O<sub>11</sub>P·K 651.55

NG07985

1mg	\$475.00
2mg	\$925.00
5mg	\$1625.00

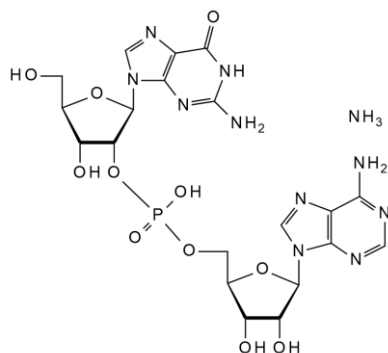
**Guanylyl-3',5'-guanosine ammonium salt**[97403-87-7] C<sub>20</sub>H<sub>25</sub>N<sub>10</sub>O<sub>12</sub>P·H<sub>3</sub>N 645.48

NG11482

1mg	\$475.00
2mg	\$925.00
5mg	\$1625.00

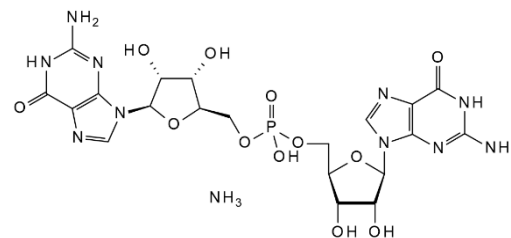

G

**Guanylyl-3'-5'-uridine ammonium salt**

• GpU

[41547-83-5] C<sub>19</sub>H<sub>24</sub>N<sub>7</sub>O<sub>13</sub>P·NH<sub>3</sub> 606.45

NG07983

1mg	\$475.00
2mg	\$925.00
5mg	\$1625.00

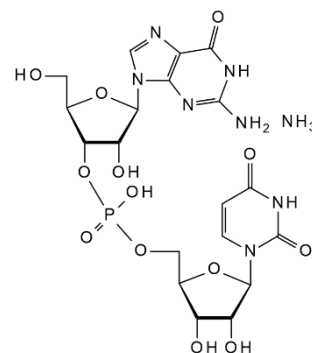
**m2G**see *N2-Methylguanosine, NM35522* on page 319**2'-O-Hexylamino-5'-O-DMT-adenosine**see *5'-O-DMT-2'-O-hexylaminoadenosine, ND08516* on page 257**Hivid**see *2',3'-Dideoxycytidine, ND06559* on page 240**Guanylyl-3'-5'-cytidine ammonium salt**

• GpC

[98046-67-4] C<sub>19</sub>H<sub>25</sub>N<sub>8</sub>O<sub>12</sub>P·NH<sub>3</sub> 605.46

NG07984

1mg	\$295.00
2mg	\$550.00
5mg	\$1250.00

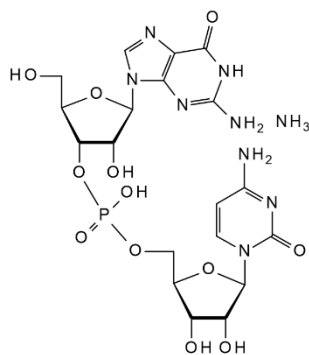

**Hydrazinoade****2-Hydrazinoadenosine**[15763-11-8] C<sub>10</sub>H<sub>15</sub>N<sub>7</sub>O<sub>4</sub> 297.27

NH06266

25mg	\$85.00
50mg	\$140.00
100mg	\$230.00

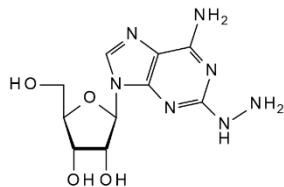

Refs: Niiya K, et al, J. Med. Chem 1992, 35, p4557; Kim H, Haley BE, J. Biol. Chem. 1990, 265, 7, p3636

**5'-Hydrazino-5'-deoxyguanosine**[1189743-60-9] C<sub>10</sub>H<sub>15</sub>N<sub>7</sub>O<sub>4</sub> 297.27

NH16032

5mg	\$84.00
10mg	\$126.00
25mg	\$210.00

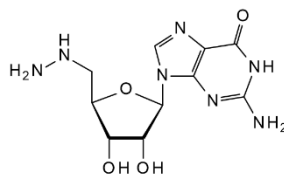
**2-Hydrazinopyrimidine**see *Pyrimidine-2-ylhydrazine*, NP57400 on page 347**2-Hydrazino-4-(trifluoromethyl)pyrimidine**

[197305-97-8]

NH44264

Price On Application

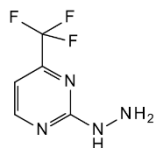
**2-Hydroxy-D-adenosine hydrate**see *Isoguanosine hydrate*, NI07234 on page 298**8-Hydroxyadenosine**[29851-57-8] C<sub>10</sub>H<sub>13</sub>N<sub>5</sub>O<sub>5</sub> 283.25

NH08494

50mg	\$75.00
100mg	\$125.00
250mg	\$250.00

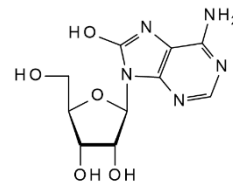

Refs: Douki et al, J. Chim. Phys. Physico-Chim. Biol, 1999, 96, p138

**N6-(2-Hydroxybenzyl)adenosine-5'-monophosphate**see *o-Topolin riboside-5'-monophosphate sodium salt*, NT30289 on page 367**N6-(3-Hydroxybenzyl)adenosine-5'-monophosphate**see *m-Topolin riboside-5'-monophosphate salt*, NT30285 on page 367**N6-(4-Hydroxybenzyl)adenosine-5'-monophosphate**see *p-Topolin riboside-5'-monophosphate sodium salt*, NT30293 on page 367**N6-(2-hydroxybenzyl)adenosine**see *o-Topolin riboside*, NT30288 on page 367**N6-(3-Hydroxybenzyl)adenosine**see *m-Topolin riboside*, NT30283 on page 367**N6-(4-Hydroxybenzyl)adenosine**see *p-Topolin riboside*, NT30291 on page 368**6-(2-Hydroxybenzylamino)-9-b-D-ribofuranosylpurine-5'-monophosphate disodium monohydrate**see *o-Topolin riboside-5'-monophosphate sodium salt*, NT30289 on page 367**6-(3-Hydroxybenzylamino)-9-b-D-ribofuranosylpurine-5'-monophosphate disodium monohydrate**see *m-Topolin riboside-5'-monophosphate salt*, NT30285 on page 367**6-(4-Hydroxybenzylamino)-9-b-D-ribofuranosylpurine-5'-monophosphate disodium monohydrate**see *p-Topolin riboside-5'-monophosphate sodium salt*, NT30293 on page 367

**6-(2-Hydroxybenzylamino)-9-b-D-ribofuranosylpurine**see *o*-Topolin riboside, NT30288 on page 367**6-(3-Hydroxybenzylamino)-9-b-D-ribofuranosylpurine**see *m*-Topolin riboside, NT30283 on page 367**6-(4-Hydroxybenzylamino)-9-b-D-ribofuranosylpurine**see *p*-Topolin riboside, NT30291 on page 368**5-(4-Hydroxybutyn-1-yl)uridine**[85267-67-0] C<sub>13</sub>H<sub>16</sub>N<sub>2</sub>O<sub>7</sub> 312.28

NH15515

Price On Application

**8-Hydroxy-2'-deoxyguanosine**

see 2'-Deoxy-8-oxoguanosine, ND06344 on page 218

**8-Hydroxy-D-guanosine**

see 8-Oxoguanosine, NO05772 on page 338

**1-(2R,3R,4R,5R)-3-Hydroxy-5-(hydroxymethyl)-4-methoxytetrahydrofuran-2-yl)-5-methylpyrimidine-2,4(1H,3H)-dione**

NH137506

Price On Application

**1-[5-O-[Hydroxy[[hydroxy(phosphonooxy)phosphinyl]oxy]phosphinyl]-b-D-ribofuranosyl]-3-(1-naphthalenylmethyl)-1H-pyrazolo[3,4-d]pyrimidin-4-amine**

see 4-Amino-3-(1-naphthylmethyl)-1H-pyrazolo[3,4-d]pyrimidine-1-(b-D-ribofuranosyl-5'-triphosphate), NA16506 on page 59

**1-[5-O-[Hydroxy[[hydroxy(phosphonooxy)phosphinyl]oxy]phosphinyl]-b-D-ribofuranosyl]-3-(phenylmethyl)-1H-pyrazolo[3,4-d]pyrimidin-4-amine**

see 4-Amino-3-benzyl-1H-pyrazolo[3,4-d]pyrimidine 1-b-D-ribofuranosyl 5'-triphosphate, NA16508 on page 38

**4-Hydroxy-2-mercaptopteridine**[52023-48-0] C<sub>6</sub>H<sub>4</sub>N<sub>4</sub>OS 180.19

NH67971

250mg	\$175.00
500mg	\$280.00
1g	\$445.00

**N6-(4-Hydroxy-3-methylbut-2-enyl)adenosine**

see Zeatin riboside, NZ08027 on page 385

**6-((E)-4-hydroxy-3-methylbut-2-enylamino)-9-b-D-ribofuranosylpurine**see *trans*-Zeatin riboside, NZ30302 on page 385**6-((E)-4-hydroxy-3-methylbut-2-enylamino)-9-b-D-ribofuranosyl-purine-5'-monophosphate disodium monohydrate**see *trans*-Zeatin riboside-5'-monophosphate sodium salt, NZ30328 on page 385**6-(4-hydroxy-3-methylbutylamino)-9-b-D-ribofuranosyl purine-5'-monophosphate disodium monohydrate**

see Dihydrozeatin riboside-5'-monophosphate sodium salt, ND30226 on page 248

**6-(4-hydroxy-3-methylbutylamino)-9-b-D-ribofuranosylpurine**

see Dihydrozeatin riboside, ND30220 on page 248

**5-Hydroxymethylcytidine**[19235-17-7] C<sub>10</sub>H<sub>15</sub>N<sub>3</sub>O<sub>6</sub> 273.24

NH35521

5mg	\$75.00
10mg	\$125.00
25mg	\$225.00

**trans(-)-2-Hydroxymethyl-5-(cytosin-1-yl)-1,3-oxathiolane**

see 2'-Epi-lamivudine, NE22731 on page 268

**5-Hydroxymethyl-dCTP.Li**

see 2'-Deoxy-5-hydroxymethylcytidine-5'-triphosphate lithium salt - 100 mM aqueous solution, ND71643 on page 207

**Hydroxymethyl****5-Hydroxymethyl-2'-deoxycytidine**[7226-77-9] C<sub>10</sub>H<sub>13</sub>N<sub>3</sub>O<sub>5</sub> 257.24

NH15898

1mg	\$65.00
2mg	\$100.00
5mg	\$120.00

**7'-Hydroxymorpholino T monomer**[914361-76-5] C<sub>29</sub>H<sub>29</sub>N<sub>3</sub>O<sub>4</sub> 483.56

NH138533

2g \$1000.00

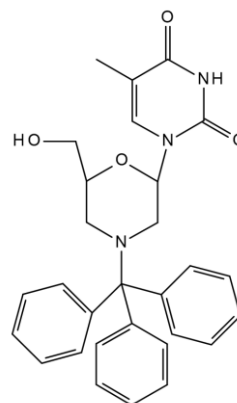

H

**(2S,4S)-1[2-hydroxymethyl-1,3-dioxolan-4-yl]uracil**[207920-78-3] C<sub>8</sub>H<sub>10</sub>N<sub>2</sub>O<sub>5</sub> 214.18

NH44934

Price On Application

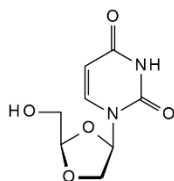
**4-Hydroxy-6-methylpyrimidine**

- 6-Methylpyrimidin-4-ol
- 6-Methyl-4(3H)-pyrimidinone

[3524-87-6] C<sub>5</sub>H<sub>6</sub>N<sub>2</sub>O 110.11

NH66985

500mg	\$60.00
1g	\$100.00
2g	\$160.00

**S-(2-Hydroxy-5-nitrobenzoyl)-6-thioguanosine**

- 2-Amino-6-[(2-hydroxy-5-nitrobenzyl)thio]-9-(β-D-ribofuranosyl)purine

[41094-07-9] C<sub>17</sub>H<sub>18</sub>N<sub>6</sub>O<sub>7</sub>S 450.43

NH08019

10mg	\$89.30
25mg	\$157.50
50mg	\$262.50

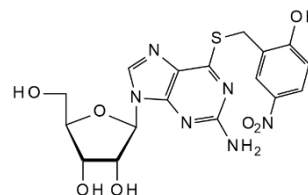
**5-(Hydroxymethyl)pyrimidine**[25193-95-7] C<sub>5</sub>H<sub>6</sub>N<sub>2</sub>O 110.11

NH57421

500mg	\$80.00
1g	\$193.20
2g	\$309.10

**S-(2-Hydroxy-5-nitrobenzoyl)-6-thioinosine**

- 6-[(2-Hydroxy-5-nitrobenzyl)thio]-9-β-D-ribofuranosylpurine

[56964-73-9] C<sub>17</sub>H<sub>17</sub>N<sub>5</sub>O<sub>7</sub>S 435.41

NH08020

10mg	\$89.30
25mg	\$157.50
50mg	\$262.50

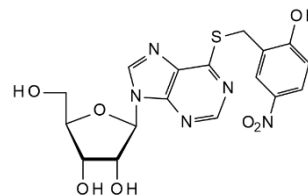
**4-Hydroxy-1-(3-O-methyl-β-D-ribofuranosyl)-2(1H)-Pyridinone**

see 3-Deaza-3'-O-methyluridine, ND58310 on page 169

**6-[(2-Hydroxy-5-nitrobenzyl)thio]-9-b-D-ribofuranosylpurine**see *S*-(2-Hydroxy-5-nitrobenzoyl)-6-thioinosine, *NH08020* on page 290**4-Hydroxy-5-nitroso-2,6-diaminopyrimidine**

NH71308	25g	\$50.00
	50g	\$90.00
	100g	\$150.00

**(S)-9-[3-Hydroxy-2-(phosphorylmethoxy)propyl]adenine**

[92999-29-6]

NH137606

Price On Application

**5-(3-Hydroxypropyn-1-yl)uridine**

NH15525

Price On Application

**4-Hydroxy-1-b-D-ribofuranosyl-2(1H)-pyridinone**see *3-Deazaauridine*, *ND16524* on page 170**4-Hydroxy-1-(2,3,5-tri-O-benzoyl-b-D-ribofuranosyl)-2(1H)-pyridinone**see *2',3',5'-Tri-O-benzoyl-3-deazaauridine*, *NT58307* on page 373**2-Hydroxy-4-trifluoromethyl-pyrimidine-5-carboxylic acid ethyl ester**see *Ethyl 2-hydroxy-4-(trifluoromethyl)pyrimidine-5-carboxylate*, *NE57399* on page 272**4-Hydroxy-1-(5-O-triphospho-b-D-ribofuranosyl)-2(1H)-pyridinone**see *3-Deazaauridine 5'-O-triphosphate lithium salt - 100 mM aqueous solution*, *ND58306* on page 170**5-Hydroxyuridine**

• 1-b-D-Ribofuranosylisobarbituric acid

[957-77-7] C<sub>9</sub>H<sub>12</sub>N<sub>2</sub>O<sub>7</sub> 260.2

NH32540

25mg	\$75.00
50mg	\$132.00
100mg	\$240.00

**IB-MECA**see *N*(6)-(3-Iodobenzyl)-5'-*N*-methylcarboxamidoadenosine, *NI10756* on page 294**N2-iBu-DMT-2'-F-dG**see *2'-Deoxy-5'-O-DMT-2'-fluoro-N2-isobutyrylguanosine*, *ND08524* on page 183**N-IbuG**see *N2-Isobutyrylguanosine*, *NI03488* on page 296**5'-Iddc**see *5'-Iodo-2',3'-dideoxycytidine*, *NI57361* on page 294**Idoxuridine**see *2'-Deoxy-5-iodouridine*, *ND05147* on page 210**IDP.2Na**see *Inosine 5'-diphosphate disodium salt*, *NI10699* on page 292**IDP.3Na**see *Inosine 5'-diphosphate trisodium salt*, *NI10027* on page 292**5I-dUTP**see *2'-Deoxy-5-iodouridine-5'-triphosphate sodium salt - 10mM aqueous solution*, *ND31484* on page 210**Imidazosagatriazinone**see *5-(2-Ethoxyphenyl)-1-methyl-3-n-propyl-1,6-dihydro-7H-pyrazolo[4,3-d]pyrimidin-7-one*, *NE16544* on page 270

**IMPGMP****IMP + GMP**

NI11887

Price On Application

**IMP**see *Inosine 5'-monophosphate*, NI10026 on page 292**Inosine-3',5'-cyclic-monophosphate free acid**[3545-76-4] C<sub>10</sub>H<sub>11</sub>N<sub>4</sub>O<sub>7</sub>P 330.19

NI10382

1mg	\$52.50
5mg	\$115.50
10mg	\$210.00

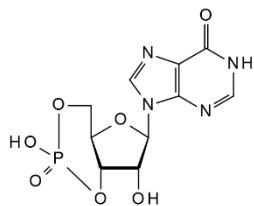
**Inosine 5'-diphosphate disodium salt**

• IDP.2Na

[54735-61-4] C<sub>10</sub>H<sub>12</sub>N<sub>4</sub>O<sub>11</sub>P<sub>2</sub>·2Na 472.15

NI10699

2g	\$50.00
5g	\$95.00
10g	\$175.00

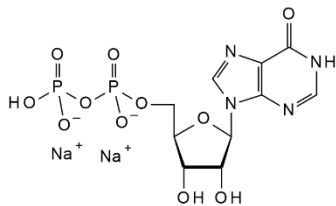
**Inosine 5'-diphosphate trisodium salt**

• IDP.3Na

[81012-88-6] C<sub>10</sub>H<sub>11</sub>N<sub>4</sub>O<sub>11</sub>P<sub>2</sub>·3Na 494.13

NI10027

100mg	\$120.00
250mg	\$195.00
500mg	\$350.00

**Inosine 5'-monophosphate disodium salt hydrate**[4691-65-0][352195-40-5][20813-76-7] C<sub>10</sub>H<sub>11</sub>N<sub>4</sub>O<sub>6</sub>PNa<sub>2</sub>·xH<sub>2</sub>O 392.17

NI02985

100g	\$55.00
250g	\$95.00
500g	\$145.00

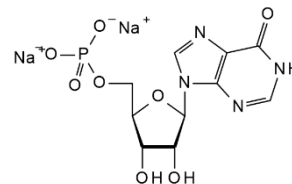
H<sub>2</sub>O**Inosine 5'-monophosphate**• Inosinic acid  
• IMP[131-99-7] C<sub>10</sub>H<sub>13</sub>N<sub>4</sub>O<sub>6</sub>P 348.2

NI10026

500mg	\$95.00
1g	\$168.00
2g	\$262.50





**Inosine 5'-triphosphate disodium salt**[36051-67-9] C<sub>10</sub>H<sub>13</sub>N<sub>4</sub>O<sub>14</sub>P<sub>3</sub>·2Na 552.13

NI09674

250mg	\$80.00
500mg	\$140.00
1g	\$262.50

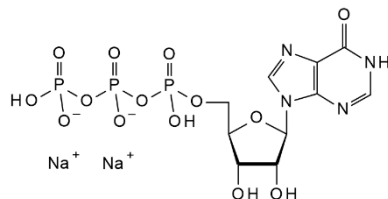
**Inosine 5'-triphosphate trisodium salt**[35908-31-7] C<sub>10</sub>H<sub>12</sub>N<sub>4</sub>O<sub>14</sub>P<sub>3</sub>·Na<sub>3</sub> 574.11

NI09673

2g	\$52.50
5g	\$78.80
10g	\$136.50

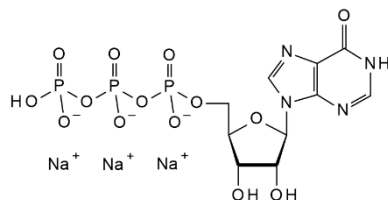
**Inosine**[58-63-9] C<sub>10</sub>H<sub>12</sub>N<sub>4</sub>O<sub>5</sub> 268.23

NI06297

250g	\$50.00
500g	\$80.00
1kg	\$140.00

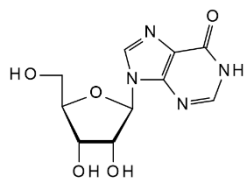

Refs: Krenitsky TA, Mol. Pharmacol. 3, p526

**L-Inosine**[21138-24-9] C<sub>10</sub>H<sub>12</sub>N<sub>4</sub>O<sub>5</sub> 268.23

NI06221

25mg	\$90.00
50mg	\$150.00
100mg	\$250.00

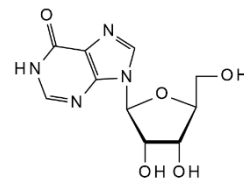

Refs: Liaudet L, Mabley JG, Pacher P, Virag L, Soriano FG, Marton A, Hasko G, Deitch EA, Szabo C, Ann. Surg. 2002, Vol235, Pt4, p568-578

**Inosinic acid**see *Inosine 5'-monophosphate*, NI10026 on page 292**2-Iodo-D-adenosine 2',3'-acetonide**see *2-Iodo-2',3'-O-isopropylideneadenosine*, NI04752 on page 295**2-Iodoadenosine 5'-carboxy-2',3'-acetonide**see *5'-Carboxy-2-iodo-2',3'-O-isopropylideneadenosine*, NC05725 on page 137**2-Iodoadenosine**

• 6-Amino-2-iodo-9-(beta-D-ribofuranosyl)purine

[35109-88-7] C<sub>10</sub>H<sub>12</sub>IN<sub>5</sub>O<sub>4</sub> 393.14

NI04749

100mg	\$79.00
250mg	\$132.50
500mg	\$225.00

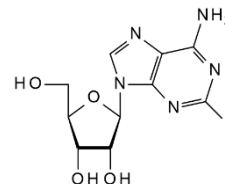

Refs: Lowry BA, et al, J. Biol. Chem. 1952, 197, p591; Huang M, et al, J. Med. Chem. 1972, 15, p462; Hagen C, Biochem. Biophys. Acta. 1973, 293, 105; Suhadolnik RJ, Nucleosides As Biological Probes, Wiley, NY, 1979, p79; Nair V, Young DA, J. Org. Chem. 1985, 50, p406

**8-Iodoadenosine**[31281-88-6] C<sub>10</sub>H<sub>12</sub>IN<sub>5</sub>O<sub>4</sub> 393.14

NI36298

Price On Application



**Iodobenzylme****N(6)-(3-Iodobenzyl)-5'-N-methylcarboxamidoadenosine**

- IB-MECA
- 1-Deoxy-1-[6-[(3-Iodophenyl)methyl]amino]-9H-purin-9-yl]-N-methyl-b-D-ribofuranuronamide

[152918-18-8] C<sub>18</sub>H<sub>19</sub>IN<sub>6</sub>O<sub>4</sub> 510.29

NI10756	50mg	\$1050.00
	100mg	\$1750.00
	250mg	\$2125.00

**6-(4-Iodobenzyl)-1-Methyl Pyrimidine-2,4-(1H,3H)-Dione**

NI44327

Price On Application

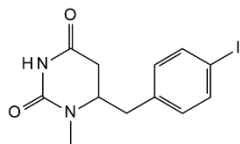
**5-Iodocytidine**

- 1-b-D-Ribofuranosyl-5-iodocytosine

[1147-23-5] C<sub>9</sub>H<sub>12</sub>IN<sub>3</sub>O<sub>5</sub> 369.11

NI04748	1g	\$50.00
	2g	\$90.00
	5g	\$175.00

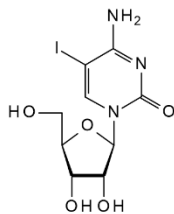

Refs: Ferrer R, Wiersma EM, Kazimierczak M, Mueller B, Eritja CW, Bioconjugate Chem. 1997, 8, 5, p757

**7-Iodo-7-deaza-2'-deoxyguanosine**

NI31361	10mg	\$210.00
	25mg	\$446.50
	50mg	\$735.00

**7-Iodo-7-deaza-2'-C-methylguanosine**

NI14082

Price On Application

**5-Iodo-2'-deoxy-L-uridine**see *ent-iodoxuridine*, NE16541 on page 267**5'-Iodo-2',3'-dideoxycytidine**

- 5'-Iddc

C<sub>8</sub>H<sub>12</sub>N<sub>3</sub>O<sub>3</sub>I 337.11

NI57361	25mg	\$140.00
	50mg	\$279.00
	100mg	\$446.00

**5'-Iodo-2',3'-dideoxyuridine**

338.1

NI57364

Price On Application

**5-Iodo-3,7-dihydro-pyrrolo[2,3-δ]pyrimidin-4-one**see *3,7-Dihydro-5-iodo-4-oxo-4H-pyrrolo[2,3-d]pyrimidine*, ND57427 on page 247**5-Iodo-2'-fluorouridine**see *2'-Deoxy-2'-fluoro-5-iodouridine*, ND07901 on page 198

**2-Iodo-2',3'-O-isopropylideneadenosine**

• 2-Iodo-D-adenosine 2',3'-acetonide

[141018-25-9] C<sub>18</sub>H<sub>16</sub>IN<sub>5</sub>O<sub>4</sub> 433.21

NI04752

10mg	\$110.30
25mg	\$223.50
50mg	\$367.50

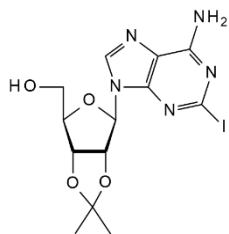
**2-Iodo-Isopropylidene-NECA**

see 5'-Ethylcarboxamido-2-iodo-2',3'-O-isopropylideneadenosine, NE03797 on page 271

**2-Iodo-9-(2,3-O-isopropylidene-b-D-ribofuranosyl uronic acid)adenine**

see 5'-Carboxy-2-iodo-2',3'-O-isopropylideneadenosine, NC05725 on page 137

**3-Iodo-1-(2-C-methyl-b-D-ribofuranosyl)-1H-pyrazolo[3,4-d]pyrimidin-4-amine,**

[847551-00-2]

NI14087

Price On Application

**5-Iodo-2'-O-methyluridine**[34218-84-3] C<sub>10</sub>H<sub>13</sub>IN<sub>2</sub>O<sub>6</sub> 384.12

NI06234

1g	\$450.00
2g	\$750.00
5g	\$1500.00

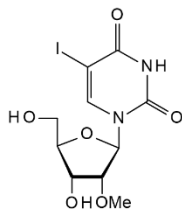
**2-Iodo-NECA**

see 5'-Ethylcarboxamido-2-iodoadenosine, NE06317 on page 271

**5-Iodo-1-(2',3',5'-tri-O-acetyl-b-D-ribofuranosyl)-imidazo-4-carbonitrile**C<sub>15</sub>H<sub>16</sub>IN<sub>3</sub>O<sub>7</sub> 477.21

NI10022

1mg	\$84.00
2mg	\$126.00
5mg	\$210.00

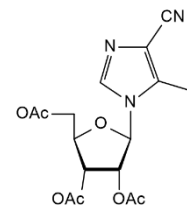
**5-Iodotubercidin**

see 7-Deaza-7-iodoadenosine, ND09248 on page 169

**5-Iodouridine**

- 5-Iodouridine
- 5-Iodo-1-(b-D-ribofuranosyl)uracil

[1024-99-3] C<sub>9</sub>H<sub>11</sub>IN<sub>2</sub>O<sub>6</sub> 370.1

NI02225

500mg	\$70.00
1g	\$99.80
2g	\$178.50

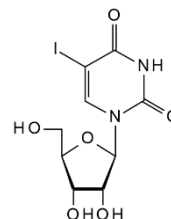
**4-(Isobutylamino)-2-(Methylthio)Pyrimidine-5-Carboxylic Acid**C<sub>10</sub>H<sub>15</sub>N<sub>3</sub>O<sub>2</sub>S 241.31

NI57385

25mg	\$93.00
50mg	\$174.50
100mg	\$279.00



**Isobutyrylar****N2-Isobutyryl-9-(β-D-arabinofuranosyl)guanine**C<sub>14</sub>H<sub>19</sub>N<sub>5</sub>O<sub>6</sub> 353.33

NI08521

5mg	\$60.00
10mg	\$105.00
25mg	\$185.00

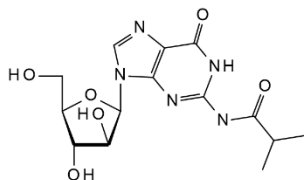
**N2-Isobutyryl-7'-t-butylidimethyl silyloxy-N-trityl-morpholino guanosine**

NI138673

5g	\$3950.00
10g	\$5970.00

**N4-Isobutyryl-2'-deoxy-5'-O-DMT-cytidine**

see 2'-Deoxy-5'-O-DMT-N4-isobutyrylcytidine, ND02997 on page 186

**N2-Isobutyryl-2'-deoxy-5'-O-DMT-D-guanosine**

see 2'-Deoxy-5'-O-DMT-N2-isobutyrylguanosine, ND02998 on page 186

**N2-Isobutyryl-2'-deoxyguanosine**

see 2'-Deoxy-N2-isobutyrylguanosine, ND02989 on page 211

**N2-Isobutyryl-2'-deoxy-5'-O-pixylguanosine**C<sub>33</sub>H<sub>31</sub>N<sub>5</sub>O<sub>6</sub> 593.64

NI08571

Price On Application

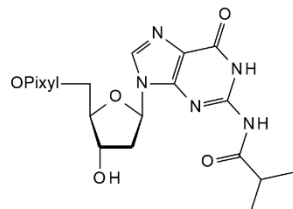
**[(2S,6R)-6-(N2-(Isobutyryl)-O6-(diphenylcarbomoyl)guanin-9-yl)-4-tritylmorpholin-2-yl]methyl dimethyl-phosphoramidochloridate**[1357354-76-7] C<sub>48</sub>H<sub>48</sub>ClN<sub>8</sub>O<sub>6</sub>P 899.37

NI58200

Price On Application

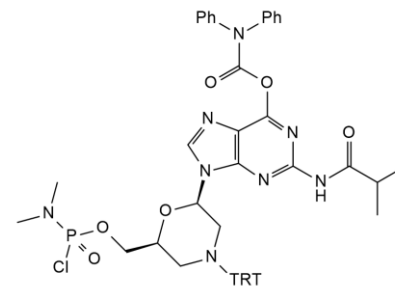
**N2-Isobutyryl-5'-O-DMT-2'-O-methyl-D-guanosine**

see 5'-O-DMT-N2-isobutyryl-2'-O-methylguanosine, ND03004 on page 259

**N2-Isobutyryl-2'-fluoro-deoxyguanosine**

see 2'-Deoxy-2'-fluoro-N2-isobutyrylguanosine, ND08523 on page 198

**N2-Isobutyrylguanosine**

• N-lbuG

[64350-24-9] C<sub>14</sub>H<sub>19</sub>N<sub>5</sub>O<sub>6</sub> 353.33

NI03488

10g	\$40.00
25g	\$60.00
50g	\$115.00

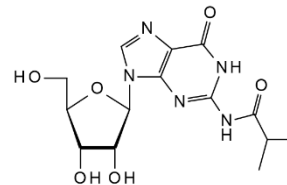

Refs: Massey AP, Sigurdsson ST, Nucleic Acids Res. 2004, Vol32, No6, p2017-202

**N2-Isobutyryl-7'-HO-N-trityl-morpholino guanosine**

NI138672

5g	\$3950.00
10g	\$5970.00



**N2-Isobutyryl-2'-(2-methoxyethyl)guanosine**

NI138523

Price On Application

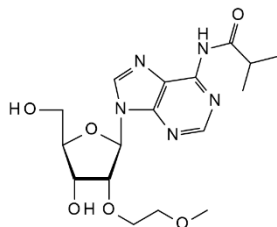
**N6-Isobutyryl-2'-O-methyladenosine**C<sub>15</sub>H<sub>21</sub>N<sub>5</sub>O<sub>5</sub> 351.36

NI08338

Price On Application

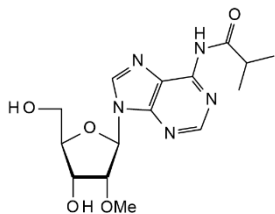
**N2-Isobutyryl-2'-O-methylguanosine**[63264-29-9] C<sub>15</sub>H<sub>21</sub>N<sub>5</sub>O<sub>6</sub> 367.36

NI08522

500mg	\$200.00
1g	\$175.00
2g	\$300.00

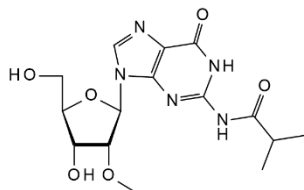
**N2-Isobutyryl-7'-OH-Morpholino guanosine**

• N-[6,9-Dihydro-9-[(2R,6S)-6-(hydroxymethyl)-2-morpholinyl]-6-oxo-1H-purin-2-yl]-2-methyl-propanamide

[956139-23-4] C<sub>14</sub>H<sub>20</sub>N<sub>6</sub>O<sub>4</sub> 336.35

NI76867

Price On Application

**N2-Isobutyryl-3',5'-O-(1,1,3,3-tetraisopropyl-1,3-disiloxanediyl)guanosine**

• N2-Isobutyryl-3',5'-O-TIPPS-guanosine  
• 3',5'-O-TIPPS-N2-isobutyrylguanosine

[87865-78-9] C<sub>26</sub>H<sub>45</sub>N<sub>5</sub>O<sub>7</sub>Si<sub>2</sub> 595.84

NI09331

1g	\$60.00
2g	\$100.00
5g	\$200.00

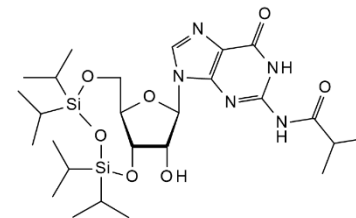
**N2-Isobutyryl-3',5'-O-TIPPS-guanosine**

see *N2-Isobutyryl-3',5'-O-(1,1,3,3-tetraisopropyl-1,3-disiloxanediyl)guanosine*, NI09331 on page 297

**N2-Isobutyryl-5'-O-Trt-guanosine**C<sub>33</sub>H<sub>32</sub>N<sub>5</sub>O<sub>6</sub> 594.64

NI57525

Price On Application



**Isocytidinet****Isocytidine triphosphate triethylamine salt**

[150668-55-6]  $C_9H_{16}N_3O_{14}P_3 \cdot xC_6H_{15}N$  483.16 (free acid basis)  
 Price On Application  
 NI61633

**Isocytidine**

• 2-Amino-1-β-D-ribofuranosyl-4(1H)-pyrimidinone

[489-59-8]  $C_9H_{13}N_3O_5$  243.22

NI24672 10mg \$149.90  
 25mg \$272.50  
 50mg \$496.00

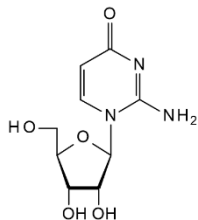

Refs: Dorskocil, J. et al, Nuc. Acid Res, 1, 1209 (1974); Chen, X. et al, Am. J. Chem. Soc, 123, 1267 (2001)

**Isoguanosine hydrate**

• 2-Hydroxy-D-adenosine hydrate  
 • Crotonoside

[359436-55-8]  $C_{10}H_{13}N_5O_5 \cdot H_2O$  301.26

NI07234 5mg \$68.00  
 10mg \$100.00  
 25mg \$195.00

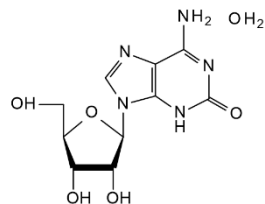

Refs: Divakar KJ. et al, J.Chem.Soc. Perkin Trans, 1991, 1, p771; Montsch HH. et al, Biochemistry, 1975, 14, p5593; Hagen C, Biochim. Biophys. Acta, 1973, 293, p105; Huang M, et al, J. Med. Chem, 1972, 15, p462

**Isoguanosine triacetate**

see 2',3',5'-Tri-O-acetylisoguanosine, NT07233 on page 372

**Isoguanosine**

see 9-(β-D-Ribofuranosyl)isoguanine, NR09651 on page 351

**N6-Isopentenyladenosine-5'-monophosphate sodium salt**

• 6-(3,3-dimethylallylamino)-9-β-D-ribofuranosylpurine-5'-monophosphate disodium monohydrate

[20268-93-3]  $C_{15}H_{20}N_5Na_2O_7 \cdot P \cdot H_2O$  477.32

NI30240 1mg \$450.00  
 2mg \$700.00  
 5mg \$1475.00

**N6-Isopentenyladenosine-D6**

$C_{15}H_{15}N_5O_4D_6$  341.39

NI09914

Price On Application

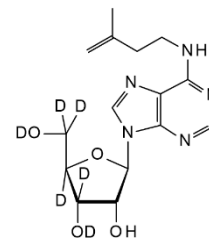
**N6-(2-Isopentenyl)adenosine**

see 6-(3,3-Dimethylallylamino)-9-(β-D-ribofuranosyl)purine, ND08001 on page 251

**5-Isopropyl-2'-deoxyuridine**

• 2'-Deoxy-5-(1-methylethyl)uridine  
 • 2'-Deoxy-5-isopropyluridine  
 • 5-Isopropyldeoxyuridine

[60136-25-6]  $C_{12}H_{18}N_2O_5$  270.28

NI16765 1mg \$139.90  
 2mg \$254.40  
 5mg \$462.50

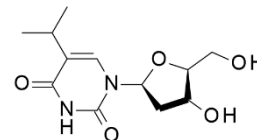

Refs: Levin, R, et al, Cancer, 72, 2895 (1993); Cook, G, et al, Chem. Biol, 6, 451 (1999)

**5-Isopropyldeoxyuridine**

see 5-Isopropyl-2'-deoxyuridine, NI16765 on page 298

**2',3'-Isopropylideneadenosine-5'-carboxylic acid**

see 5'-Carboxy-2',3'-O-isopropylideneadenosine, NC07451 on page 138

**2',3'-O-Isopropylideneadenosine**[362-75-4] C<sub>13</sub>H<sub>17</sub>N<sub>5</sub>O<sub>4</sub> 307.31

NI05151

25g	\$50.00
50g	\$85.00
100g	\$150.00

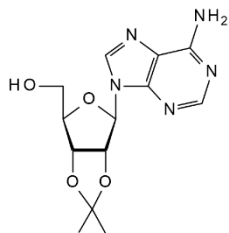
**2',3'-O-Isopropylidene-5-chlorocytidine**

see 5-Chloro-5'-deoxy-2',3'-O-isopropylidencytidine, NC04653 on page 144

**2',3'-O-Isopropylidencytidine**[362-42-5] C<sub>12</sub>H<sub>17</sub>N<sub>3</sub>O<sub>5</sub> 283.28

NI08545

5g	\$70.00
10g	\$110.00
25g	\$220.00

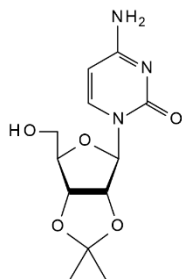
**2',3'-Isopropylidene-guanosine**

see 2',3'-O-Isopropylidene-guanosine, NI06120 on page 299

**2',3'-O-Isopropylidene-guanosine**

- 9-(2,3-O-Isopropylidene-b-D-ribofuranosyl)guanine
- 2',3'-Isopropylidene-guanosine

[362-76-5] C<sub>13</sub>H<sub>17</sub>N<sub>5</sub>O<sub>5</sub> 323.31

NI06120

10g	\$42.00
25g	\$79.00
50g	\$118.50

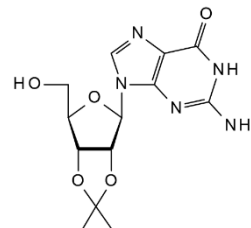
**2',3'-O-Isopropylideneinosine**[2140-11-6] C<sub>13</sub>H<sub>16</sub>N<sub>4</sub>O<sub>5</sub> 308.3

NI03500

10g	\$42.00
25g	\$79.00
50g	\$118.50

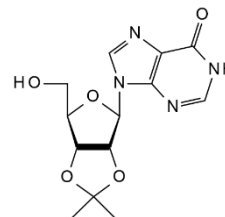
**2',3'-O-Isopropylidene-6-mercaptopurine riboside**

see 2',3'-O-Isopropylidene-6-thiinosine, NI08025 on page 300

**9-(2,3-O-Isopropylidene-b-D-ribofuranosyl)guanine**

see 2',3'-O-Isopropylidene-guanosine, NI06120 on page 299

**Isopropylide****1-[2,3-O-Isopropylidene-b-D-ribofuranosyl]-1,2,4-triazole-3-carboxylic acid methyl ester**

- 1-[2,3-O-(1-Methylethylidene)-b-D-ribofuranosyl]-1H-1,2,4-triazole-3-carboxylic acid methyl ester

[594860-43-2] C<sub>12</sub>H<sub>17</sub>N<sub>3</sub>O<sub>6</sub> 299.28

NI16557

10mg	\$149.90
25mg	\$272.50
50mg	\$496.00

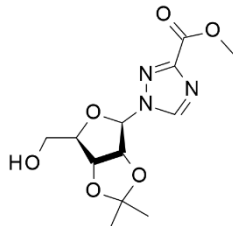

Refs: Wang, G, et al, Nucleosides, Nucleotides &amp; Nucleic Acids, 23, 317 (2004)

**2',3'-O-Isopropylidene-6-thioinosine**

- 2',3'-O-Isopropylidene-6-mercaptapurine riboside
- 6-Mercapto-9-(2,3-O-isopropylidene-b-D-ribofuranosyl)purine

[5856-48-4] C<sub>13</sub>H<sub>18</sub>N<sub>4</sub>O<sub>4</sub>S 324.36

NI08025

250mg	\$92.50
500mg	\$160.00
1g	\$262.50

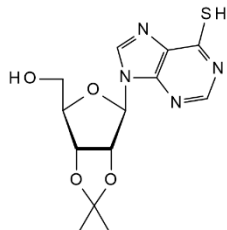
**2',3'-O-Isopropylideneuridine**

- Isopropylideneuridine

[362-43-6] C<sub>12</sub>H<sub>16</sub>N<sub>2</sub>O<sub>6</sub> 284.27

NI05371

10g	\$50.00
25g	\$65.00
50g	\$110.00

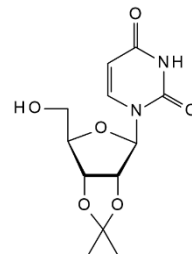

Refs: Czuchajowski L, Habdas J, Niedbala H, Wandrekar V, J. Heterocycl. Chem. 1992, Vol29, No2, p479-486

**Isopropylideneuridine**

see 2',3'-O-Isopropylideneuridine, NI05371 on page 300

**2-Isopropyl-4-pyrimidinecarbaldehyde**[944901-13-7] C<sub>8</sub>H<sub>10</sub>N<sub>2</sub>O 150.18

NI57443

250mg	\$90.00
500mg	\$145.00
1g	\$339.70

**Isoribavirin**

- Ribavirin Impurity G
- 1-b-D-Ribofuranosyl-1H-1,2,4-triazole-5-carboxamide

[39030-43-8] C<sub>8</sub>H<sub>12</sub>N<sub>4</sub>O<sub>5</sub> 244.21

NI09827

1mg	\$157.50
2mg	\$262.50
5mg	\$498.80

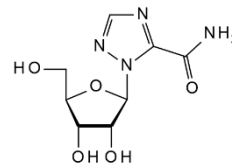



**Kinetin riboside-5'-diphosphate sodium salt**

NK76187

Price On Application

**Kinetin riboside-5'-monophosphate sodium salt**

• 6-furfurylamino-9-b-D-ribofuranosylpurine-5'-monophosphate disodium monohydrate

[13484-67-8] C<sub>15</sub>H<sub>16</sub>N<sub>5</sub>Na<sub>2</sub>O<sub>8</sub>P·H<sub>2</sub>O 489.29

NK30244

1mg	\$325.00
2mg	\$500.00
5mg	\$900.00

**Kinetin riboside-5'-triphosphate sodium salt**

NK76188

25mg \$5000.00

**Kinetin riboside**

- 6-Furfurylamino-9-b-D-ribofuranosylpurine-5'-monophosphate
- N6-Furfuryladenine
- 9-(b-D-Ribofuranosyl)-6-furfurylamino-9-b-D-ribofuranosylpurine

[4338-47-0] C<sub>15</sub>H<sub>17</sub>N<sub>5</sub>O<sub>5</sub> 347.33

NK06717

500mg	\$85.00
1g	\$160.00
2g	\$300.00

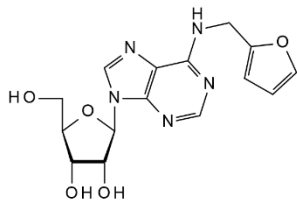

Refs: Cancer Res. 1960, 20, p1362; Virology 1969, 38, p26; Miller CO, Skoog F, Okumura FS, von Saltza FH, et al, J. Am. Chem. Soc. 1955, Vol77, p2662

**Lamivudine acid**

• (2R-cis)-5-(4-Amino-2-oxo-1(2H)-pyrimidinyl)-1,3-oxathiolane-2-carboxylic acid

[173829-09-9] C<sub>8</sub>H<sub>9</sub>N<sub>3</sub>O<sub>4</sub>S 243.24

NL34824

10mg	\$190.00
25mg	\$375.00
50mg	\$650.00

**rac-Lamivudine acid**

• cis-5-(4-Amino-2-oxo-1(2H)-pyrimidinyl)-1,3-oxathiolane-2-carboxylic acid

[173602-25-0] C<sub>8</sub>H<sub>9</sub>N<sub>3</sub>O<sub>4</sub>S 243.24

NL27534

5mg	\$150.00
10mg	\$272.60
25mg	\$496.00

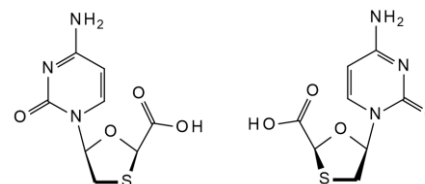

Refs: Dwyer, O, Synlett, 11, 1163 (1995)

**Lamivudine 5'-diphosphate ammonium salt**

• P-[[[(2R,5S)-5-(4-Amino-2-oxo-1(2H)-pyrimidinyl)-1,3-oxathiolan-2-yl]methyl] ester diphosphoric acid ammonium salt

[1187058-41-8] C<sub>8</sub>H<sub>19</sub>N<sub>5</sub>O<sub>9</sub>P<sub>2</sub>S 423.28

NL24830

1mg	\$965.20
2mg	\$1754.90
5mg	\$3190.70

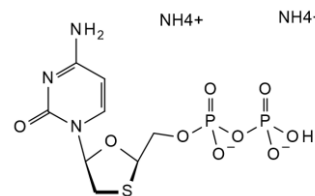

Refs: Soudeyns, H, et al, Antimicrob. Agents Chemother, 35, 1386 (1991); Denapoli, L, et al, Nucleosides Nucleotides, 12, 21 (1993)



**Lamivudinemo****Lamivudine 5'-monophosphate ammonium salt**

- 4-Amino-1-[(2R,5S)-2-[(phosphonoxy)methyl]-1,3-oxathiolan-5-yl]-2(1H)-pyrimidinone ammonium salt
- 2',3'-Dideoxy-3'-thia-cytidine-5'-monophosphate

[1187058-40-7] C<sub>8</sub>H<sub>15</sub>N<sub>4</sub>O<sub>6</sub>PS 326.27

NL24831

1mg	\$272.60
2mg	\$495.50
5mg	\$900.90

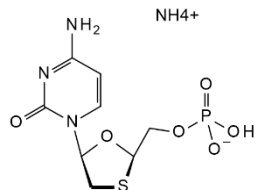

Refs: Soudeyns, H. et al, *Antimicrob. Agents Chemother.*, 35, 1386 (1991); Denapoli, L. et al, *Nucleosides Nucleotides*, 12, 21 (1993)

**Lamivudine 5'-monophosphate sodium salt**

- 4-Amino-1-[(2R,5S)-2-[(phosphonoxy)methyl]-1,3-oxathiolan-5-yl]-2(1H)-pyrimidinone sodium salt

C<sub>8</sub>H<sub>11</sub>N<sub>3</sub>O<sub>6</sub>PSNa 331.22

NL28880

Price On Application

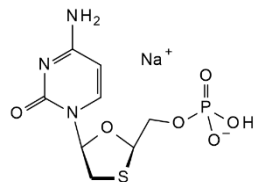
**Lamivudine 5'-monophosphate triethylammonium salt**

NL15332

1mg	\$504.00
2mg	\$882.00
5mg	\$1890.00

**Lamivudine 5'-triphosphate triethylammonium salt**[1187058-42-9] C<sub>20</sub>H<sub>46</sub>N<sub>5</sub>O<sub>12</sub>P<sub>3</sub>S 673.59

NL15940

500ug	\$195.00
1mg	\$325.00
2mg	\$640.00

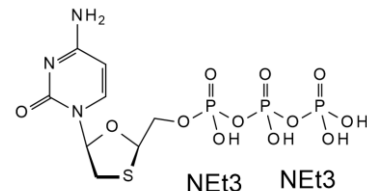
**Lamivudine**

- 3TC
- 2',3'-Dideoxy-3'-thiacytidine
- (-)-BCH-189

[134678-17-4] C<sub>8</sub>H<sub>11</sub>N<sub>3</sub>O<sub>3</sub>S 229.26

NL06295

5g	\$65.00
10g	\$95.00
25g	\$160.00

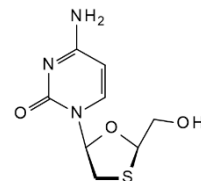
**Lauroyl coenzyme A**

- n-Dodecanoyl coenzyme A

[6244-92-4] C<sub>33</sub>H<sub>58</sub>N<sub>7</sub>O<sub>17</sub>P<sub>3</sub>S 949.84

NL47197

5mg	\$125.00
10mg	\$230.00
25mg	\$425.00

**N6-Lauroylcordycepin**

see 3'-Deoxy-N6-lauroyladenosine, ND10014 on page 212

## LDA

NL01000

Price On Application



## Leustatin

see 2-Chloro-2'-deoxyadenosine, NC06337 on page 141

## Levovir

see Clevudine, NC09470 on page 153

## 3'-O-Levinoylthymidine

C<sub>14</sub>H<sub>18</sub>N<sub>2</sub>O<sub>7</sub> 326.3

NL06915

Price On Application

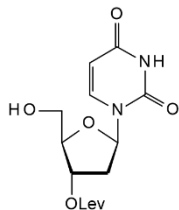

## 5'-O-Levinoylthymidine

C<sub>14</sub>H<sub>18</sub>N<sub>2</sub>O<sub>7</sub> 326.3

NL06916

Price On Application

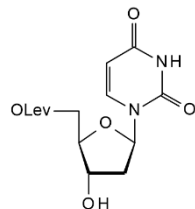

## Linoleoyl coenzyme A

• cis,cis-9,12-Octadecadienoyl coenzyme A

[6709-57-5] C<sub>38</sub>H<sub>68</sub>N<sub>7</sub>O<sub>17</sub>P<sub>3</sub>S 1029.97

NL47198

5mg	\$200.00
10mg	\$350.00
20mg	\$600.00



## LNA-G diol

see 1-(2'-O-4-C-Methylene-b-D-ribofuranosyl)guanine, NM08152 on page 317

## Lodenosine

see 6-Amino-9-(2',3'-dideoxy-2'-fluoro-b-D-arabinofuranosyl)purine, NA05179 on page 51

## 5-Iodo-1-(b-D-ribofuranosyl)uracil

see 5-Iodouridine, NI02225 on page 295

## Loxoribine

see 7-Allyl-7,8-dihydro-8-oxoguanosine, NA07175 on page 32

## Lysidine

see (2S)-2-Amino-6-((4-amino-1-[(2R,3R,4S,5R)-3,4-dihydroxy-5-(hydroxymethyl)oxolan-2-yl]-1,2-dihydropyrimidin-2-ylidene)amino)hexanoic acid, NA46541 on page 36

## Malonyl coenzyme A lithium salt - 90%

[108347-84-8] C<sub>24</sub>H<sub>38</sub>N<sub>7</sub>O<sub>18</sub>P<sub>3</sub>S·xLi 853.58 (free acid basis)

NM47199

2mg	\$70.00
5mg	\$125.00
10mg	\$225.00



**Malonylcoenz****Malonyl coenzyme A lithium salt - 97%**

[108347-84-8]  $C_{24}H_{38}N_7O_{19}P_3S \cdot xLi$  853.58 (free acid basis)  
 NM59495 5mg \$125.00  
 10mg \$230.00  
 25mg \$475.00

**1-( $\alpha$ -D-Mannopyranosyl)-6-methoxypurine**

$C_{12}H_{16}N_4O_6$  312.28

NM13189

Price On Application

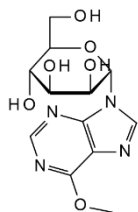
**1-( $\alpha$ -D-Mannopyranosyl)thymine**

$C_{11}H_{16}N_2O_7$  288.75

NM09535

Price On Application

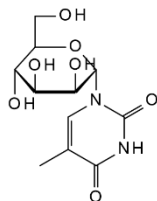
**MANT-ADP**

see 2'/3'-O-(*N*-Methylanthraniloyl)-adenosine-5'-diphosphate triethylammonium salt, NM29546 on page 311

**2'-Mant-3'-dATP**

see 2'-O-(*N*-Methylanthraniloyl)-3'-deoxy-adenosine-5'-triphosphate triethylammonium salt, NM29550 on page 312

**MANT-GTP $\gamma$ S**

see 2-/3--O-(*N*-Methylanthraniloyl)guanosine-5'-( $\gamma$ -thio)triphosphate triethylammonium salt, NM29593 on page 312

**6-Me-ATP.Na**

see *N*6-Methyladenosine-5'-triphosphate sodium salt - 10 mM aqueous solution, NM71656 on page 309

**2'-O-Me-ATP**

see 2'-O-Methyladenosine 5'-triphosphate lithium salt - 100 mM aqueous solution, NM58209 on page 309

**6-Me-ATP**

see *N*6-Methyladenosine-5'-triphosphate lithium salt - 100 mM aqueous solution, NM71655 on page 309

**2-Me-cGMP**

see *N*2-Methylguanosine-3',5'-cyclic monophosphate, NM46114 on page 317

**2'-O-Me-CTP**

see 2'-O-Methylcytidine 5'-triphosphate lithium salt - 100mM aqueous solution, NM58210 on page 314

**N4-Me-CTP**

see *N*4-Methylcytidine 5'-triphosphate triethylammonium salt, NM71657 on page 315

**5-MedCMP**

see 2'-Deoxy-5-methylcytidine-5'-monophosphate disodium salt, ND10012 on page 214

**N4-Me-dC**

see 2'-Deoxy-*N*4-methylcytidine, ND153424 on page 214

**2'-O-Me-GTP**

see 2'-O-Methylguanosine 5'-triphosphate lithium salt - 100mM aqueous solution, NM58211 on page 317

**2'-C-MeG**

see 2'-C-Methylguanosine, NM07819 on page 318

**N2-MeIQx-deoxyguanosine**

see *N*-(2-Amino-3,8-dimethylimidazo[4,5-*f*]quinoxalin-5-yl) 2'-deoxyguanosine, NA16594 on page 53

**5-Me-2'-O-MOE-C**

see 2'-O-(2-Methoxyethyl)-5-methylcytidine, NM36299 on page 307

**6-Mercapto-9-(b-D-arabinofuranosyl)purine**

see 6-Thio-9-(b-D-arabinofuranosyl)purine, NM06321 on page 358

**6-Mercapto-9-(2'-deoxy-b-D-ribofuranosyl)purine**

- 2'-Deoxy-6-thioinosine
- 6-Thiopurine-2'-deoxyriboside
- 6-Mercaptopurine-2'-deoxyriboside

[2239-64-7][2293-64-7] C<sub>10</sub>H<sub>12</sub>N<sub>4</sub>O<sub>3</sub>S 268.29

NM02964

5mg	\$85.00
10mg	\$150.00
25mg	\$275.00

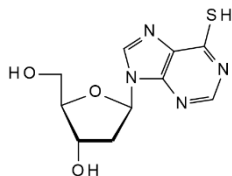
**4-Mercaptoguanosine**

see 4'-Thioguanosine, NG74932 on page 360

**6-Mercaptoguanosine**

see 6-Thioguanosine, NT04480 on page 360

**8-Mercaptoguanosine**

see 8-Thioguanosine, NT07601 on page 360

**2-Mercapto-6-hydroxyazapurine**

see 8-Aza-6-hydroxy-2-mercaptapurine, NA66851 on page 78

**6-Mercapto-9-(2,3-O-isopropylidene-b-D-ribofuranosyl)purine**

see 2',3'-O-Isopropylidene-6-thioinosine, NI08025 on page 300

**6-Mercaptopurine-2'-deoxyriboside**

see 6-Mercapto-9-(2'-deoxy-b-D-ribofuranosyl)purine, NM02964 on page 305

**6-Mercaptopurine riboside**

see 6-Thioinosine, NT08808 on page 360

**2-MeS-ATP**

see 2-Methylthioadenosine-5'-triphosphate, NM72044 on page 324

**MESG**

see 7-Methyl-6-thioguanosine inner salt, NM06560 on page 325

**Mesoxalylurea**

see Alloxan tetrahydrate, NA71089 on page 31

**2-Methanesulfonyl-4-phenyl-pyrimidine**

[56734-11-3]

NM44265

50mg	\$84.00
100mg	\$134.00
250mg	\$215.00

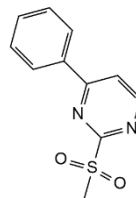
**2-Methanesulfonylpyrimidine-4-carboxylic acid**

[1370411-46-3]

NM44338

Price On Application

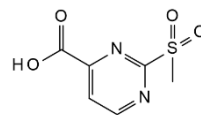
**2-Methanesulfonyl-pyrimidine**

[14161-09-2]

NM44273

250mg	\$90.00
500mg	\$145.00
1g	\$234.40

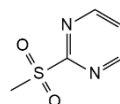
**N6-(2-Methoxybenzyl)adenosine**

see o-Methoxytopolin riboside, NM30298 on page 308

**Methoxybenzy****N6-(3-Methoxybenzyl)adenosine**see *m*-Methoxytopolin riboside, NM30295 on page 308**6-(2-Methoxybenzylamino)-9-β-D-ribofuranosylpurine**see *o*-Methoxytopolin riboside, NM30298 on page 308**6-(3-Methoxybenzylamino)-9-β-D-ribofuranosylpurine**see *m*-Methoxytopolin riboside, NM30295 on page 308**5-Methoxycarbonylmethyluridine**[29428-50-0] C<sub>12</sub>H<sub>16</sub>N<sub>2</sub>O<sub>8</sub> 316.26

NM45525

5mg	\$105.00
10mg	\$195.00
25mg	\$375.00

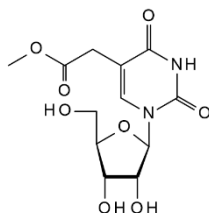
**2-Methoxy-2'-deoxyadenosine**

see 2'-Deoxy-2-methoxyadenosine, ND15747 on page 213

**2'-O-(2-Methoxyethyl)adenosine 5'-monophosphate**

NM71848

Price On Application

**2'-O-(2-Methoxyethyl)adenosine**[168427-74-5] C<sub>13</sub>H<sub>19</sub>N<sub>5</sub>O<sub>5</sub> 325.32

NM16784

1g	\$295.00
2g	\$500.00
5g	\$975.00

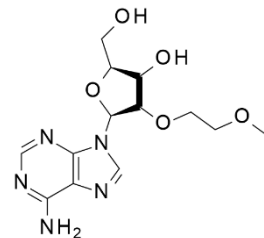

Refs: Martin, P., et al, Helv. Chim. Acta, 78, 486

**4-(2-Methoxyethylamino)-2-(Methylthio)Pyrimidine-5-Carboxylic Acid**[76360-92-4] C<sub>9</sub>H<sub>13</sub>N<sub>3</sub>O<sub>3</sub>S 243.28

NM57390

25mg	\$116.50
50mg	\$227.50
100mg	\$364.00

**2'-O-(2-Methoxyethyl)guanosine 5'-monophosphate**

NM71847

Price On Application

**2'-O-(2-Methoxyethyl)guanosine**

• 2'-O-MOE-Guanosine

[473278-54-5] C<sub>13</sub>H<sub>19</sub>N<sub>5</sub>O<sub>6</sub> 341.32

NM57537

250mg	\$67.50
500mg	\$115.00
1g	\$200.00



**2'-O-(2-Methoxyethyl)-5-methylcytidine 5'-monophosphate**

NM71850

Price On Application

**2'-O-(2-Methoxyethyl)-5-methylcytidine**

• 5-Me-2'-O-MOE-C

[244105-55-3] C<sub>13</sub>H<sub>21</sub>N<sub>3</sub>O<sub>6</sub> 315.32

NM36299

250mg	\$85.00
500mg	\$150.00
1g	\$250.00

**2'-O-(2-Methoxyethyl)-5-methyluridine 5'-monophosphate**

NM71849

Price On Application

**2'-O-(2-Methoxyethyl)-5-methyluridine**• 2'-O-Methoxyethyl-thymidine  
• 2'-O-MOE-T[163759-49-7] C<sub>13</sub>H<sub>20</sub>N<sub>2</sub>O<sub>7</sub> 316.31

NM57538

250mg	\$85.00
500mg	\$150.00
1g	\$250.00

**2-(2-Methoxyethyl)pyrimidine-5-carbaldehyde**[876717-41-8] C<sub>8</sub>H<sub>10</sub>N<sub>2</sub>O<sub>2</sub> 166.18

NM57430

250mg	\$72.50
500mg	\$115.00
1g	\$251.20

**2'-O-Methoxyethyl-thymidine**

see 2'-O-(2-Methoxyethyl)-5-methyluridine, NM57538 on page 307

**2'-O-(2-Methoxyethyl)uridine**[223777-15-9] C<sub>12</sub>H<sub>18</sub>N<sub>2</sub>O<sub>7</sub> 302.28

NM16314

100mg	\$60.00
250mg	\$125.00
500mg	\$200.00

**5-Methoxymethyl-2'-deoxyuridine**[5116-22-3] C<sub>11</sub>H<sub>16</sub>N<sub>2</sub>O<sub>6</sub> 272.25

NM34075

5mg	\$110.30
10mg	\$183.80
25mg	\$420.00

**2-(Methoxymethyl)-5-pyrimidinecarbaldehyde**[959240-25-6] C<sub>7</sub>H<sub>8</sub>N<sub>2</sub>O<sub>2</sub> 152.15

NM57442

250mg	\$72.50
500mg	\$115.00
1g	\$238.10

**4-(4-Methoxyphenyl)pyrimidin-2-amine**

see 2-Amino-4-(4-methoxyphenyl)pyrimidine, NA57406 on page 57

**Methoxypheny****4-(4-Methoxyphenyl)-2-pyrimidinethiol**[175202-77-4] C<sub>11</sub>H<sub>10</sub>N<sub>2</sub>OS 218.28

NM57412

1g	\$90.80
2g	\$167.60
5g	\$395.30

**2-Methoxy-pyrimidin-4-ylamine**

see 4-Amino-2-methoxypyrimidine, NA57396 on page 58

**m-Methoxytopolin riboside**

- 6-(3-Methoxybenzylamino)-9-b-D-ribofuranosylpurine
- N6-(3-Methoxybenzyl)adenosine

[101565-95-1] C<sub>18</sub>H<sub>21</sub>N<sub>5</sub>O<sub>5</sub> 387.39

NM30295

50mg	\$62.50
100mg	\$95.00
250mg	\$175.00

**o-Methoxytopolin riboside**

- N6-(2-Methoxybenzyl)adenosine
- 6-(2-Methoxybenzylamino)-9-b-D-ribofuranosylpurine

[23660-98-2] C<sub>18</sub>H<sub>21</sub>N<sub>5</sub>O<sub>5</sub> 387.39

NM30298

100mg	\$190.00
250mg	\$325.00
500mg	\$450.00

**5-Methoxyuridine**[35542-01-9] C<sub>10</sub>H<sub>14</sub>N<sub>2</sub>O<sub>7</sub> 274.23

NM08028

5mg	\$65.00
10mg	\$90.00
25mg	\$150.00

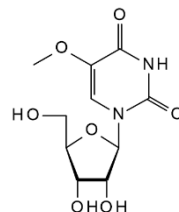
**2'-Methyl-adenosine-(benzoyl)-succinyl-CPG; 500 Å (RNA)**

NM11622

250mg	\$197.50
500mg	\$315.00
1g	\$525.00

**2'-Methyl-adenosine-(Bz)-succinyl-CPG; 500 Å (RNA)**

NM11623

1g	\$420.00
----	----------

**N1-Methyladenosine hydroiodide**[34308-25-3] C<sub>11</sub>H<sub>15</sub>N<sub>5</sub>O<sub>4</sub>·HI 409.18

NM08030

25mg	\$89.50
50mg	\$157.50
250mg	\$262.50

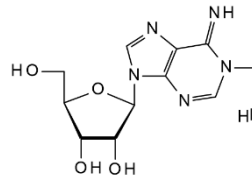



**N6-Methyladenosine-5'-monophosphate sodium salt**[81921-35-9] C<sub>11</sub>H<sub>14</sub>N<sub>5</sub>O<sub>7</sub>P·Na<sub>2</sub> 405.21

NM10586

5mg	\$80.00
10mg	\$120.00
25mg	\$200.00

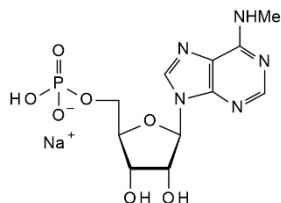
**3'-O-Methyladenosine 5'-triphosphate lithium salt**[30993-48-7 (free acid)] C<sub>11</sub>H<sub>14</sub>N<sub>5</sub>O<sub>13</sub>P<sub>3</sub>·Li<sub>4</sub> 544.94

NM46050

1mg	\$325.00
2mg	\$590.00
5mg	\$1300.00

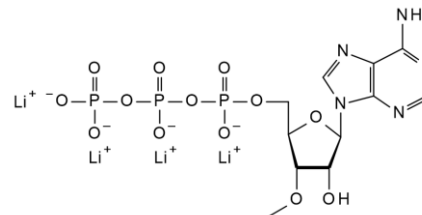
**2'-O-Methyladenosine 5'-monophosphate**

• 2'-O-Methyl-AMP

[28516-86-1] C<sub>11</sub>H<sub>16</sub>N<sub>5</sub>O<sub>7</sub>P 361.25

NM71637

100mg	\$350.00
250mg	\$550.00
500mg	\$800.00

**N6-Methyladenosine-5'-triphosphate lithium salt - 100 mM aqueous solution**

• 6-Me-ATP

[3130-39-0] C<sub>11</sub>H<sub>18</sub>N<sub>5</sub>O<sub>13</sub>P<sub>3</sub>·xLi 521.21 (free acid basis)

NM71655

500ug	\$75.00
1mg	\$145.00
2mg	\$240.00

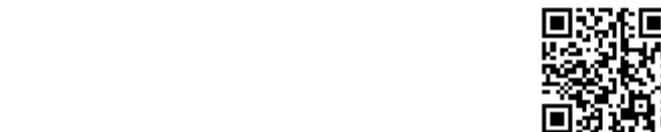
**2'-O-Methyladenosine 5'-triphosphate lithium salt - 100 mM aqueous solution**

• 2'-O-Me-ATP

[42467-24-3 (free acid)] C<sub>11</sub>H<sub>18</sub>N<sub>5</sub>O<sub>13</sub>P<sub>3</sub>·xLi 521.21 (free acid basis)

NM58209

1mg	\$95.00
2.5mg	\$200.00
5mg	\$295.00

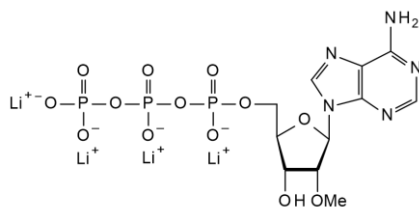
**2'-O-Methyladenosine-5'-triphosphate sodium salt - 100mM aqueous solution**

• 2'OMe-ATP.Na

[42467-24-3 (free acid)] C<sub>11</sub>H<sub>18</sub>N<sub>5</sub>O<sub>13</sub>P<sub>3</sub>·xNa 521.21 (free acid basis)

NM157272

2.5mg	\$150.00
5mg	\$250.00
10mg	\$390.00

**N6-Methyladenosine-5'-triphosphate sodium salt - 10 mM aqueous solution**

• 6-Me-ATP.Na

[3130-39-0] C<sub>11</sub>H<sub>18</sub>N<sub>5</sub>O<sub>13</sub>P<sub>3</sub> 521.21

NM71656

1mg	\$225.00
2mg	\$290.00
5mg	\$625.00



**Methyladenos****2'-C-Methyladenosine 5'-triphosphate triethyl ammonium salt - Aqueous solution**C<sub>35</sub>H<sub>79</sub>N<sub>9</sub>O<sub>13</sub>P<sub>3</sub> 926.98

NM29122

Price On Application

**2'-C-Methyladenosine**

• 2'-C-Methyladenosine

[15397-12-3] C<sub>11</sub>H<sub>15</sub>N<sub>5</sub>O<sub>4</sub> 281.27

NM07917

50mg	\$55.00
100mg	\$85.00
250mg	\$150.00

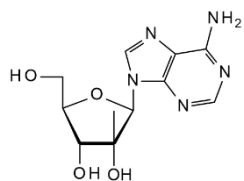
**2'-O-Methyladenosine**[2140-79-6] C<sub>11</sub>H<sub>15</sub>N<sub>5</sub>O<sub>4</sub> 281.27

NM05694

250mg	\$50.00
500mg	\$75.00
1g	\$100.00

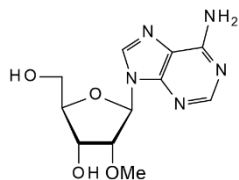

Refs: Wei et al, Proc. Nat. Acad.Sci, 1975, 72, p318; Yamada et al, Cell. Mol. Life Sci, 1998, 54, p125

**2-Methyladenosine**

see C2-Methyladenosine, NM46832 on page 310

**3'-O-Methyladenosine**[10300-22-8] C<sub>11</sub>H<sub>15</sub>N<sub>5</sub>O<sub>4</sub> 281.27

NM03526

50mg	\$115.50
100mg	\$210.00
250mg	\$342.50

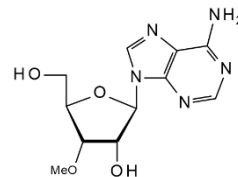
**8-Methyladenosine**[56973-12-7] C<sub>11</sub>H<sub>15</sub>N<sub>5</sub>O<sub>4</sub> 281.27

NM08548

10mg	\$75.00
25mg	\$120.00
50mg	\$184.00

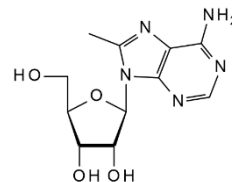
**C2-Methyladenosine**

• 2-Methyladenosine

[16526-56-0] C<sub>11</sub>H<sub>15</sub>N<sub>5</sub>O<sub>4</sub> 281.27

NM46832

1mg	\$300.00
2mg	\$500.00
5mg	\$1000.00

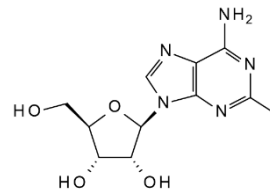

**N1-Methyladenosine**[15763-06-1] C<sub>11</sub>H<sub>15</sub>N<sub>5</sub>O<sub>4</sub> 281.27

NM03697

100mg	\$95.00
250mg	\$172.50
500mg	\$265.00

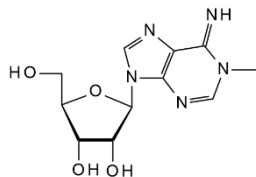
**N6-Methyladenosine**

• (-)-6-(Methylamino)purine riboside

[60209-41-8][1867-73-8] C<sub>11</sub>H<sub>15</sub>N<sub>5</sub>O<sub>4</sub> 281.27

NM32281

500mg	\$70.00
1g	\$125.00
2g	\$190.00

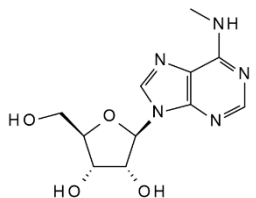
**2-Methylaminoadenosine**[13364-95-9] C<sub>11</sub>H<sub>16</sub>N<sub>6</sub>O<sub>4</sub> 296.28

NM63327

Price On Application

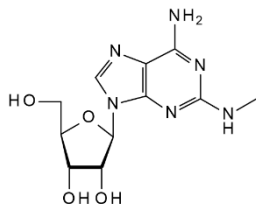
**2-[4-[(Methylamino)carbonyl]-1H-pyrazol-1-yl]-adenosine**

see Regadenoson, NR07283 on page 348

**(-)-6-(Methylamino)purine riboside**

see N6-Methyladenosine, NM32281 on page 311

**2'-O-Methyl-AMP**

see 2'-O-Methyladenosine 5'-monophosphate, NM71637 on page 309

**2'/3'-O-(N-Methylantraniloyl)-adenosine-5'-diphosphate triethylammonium salt**

• MANT-ADP

C<sub>18</sub>H<sub>22</sub>N<sub>6</sub>O<sub>11</sub>P<sub>2</sub> 560.35

NM29546

Price On Application

**2'/3'-O-(N-Methylantraniloyl)-adenosine-5'-monophosphate triethylammonium salt**[1116020-97-3][85287-53-2 (free acids)] C<sub>18</sub>H<sub>21</sub>N<sub>6</sub>O<sub>8</sub>P 480.37 (free acid)

NM29545

Price On Application

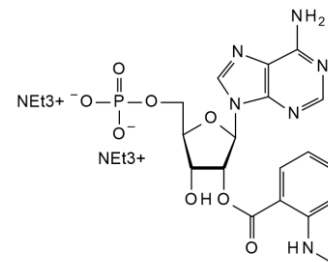
**2'/3'-O-(N-Methyl-antraniloyl)-adenosine-5'-(gamma-thio)-triphosphate triethylammonium salt**[1809315-85-2] C<sub>18</sub>H<sub>23</sub>N<sub>6</sub>O<sub>13</sub>P<sub>3</sub>S 656.40 (free acid)

NM29588

Price On Application

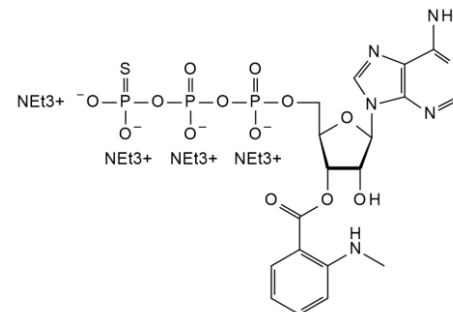

**Methylantra****2'/3'-(N-Methylantraniloyl)-adenosine-5'-triphosphate triethylammonium salt**

[175737-77-6][175737-81-2 (free acids)]  $C_{18}H_{23}N_6O_{14}P_3$  640.33 (free acid)  
 1mg \$360.00  
 2mg \$520.00  
 5mg \$725.00

NM29547

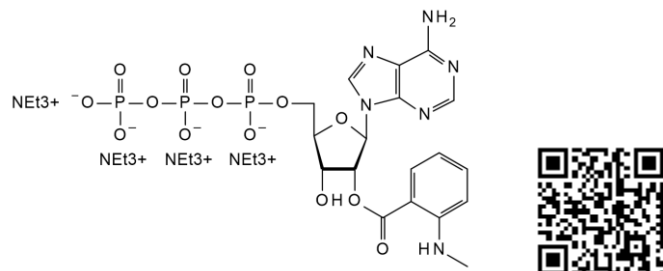
**2-/3--O-(N-Methylantraniloyl)guanosine-5'-(γ-thio)triphosphate triethylammonium salt**

• MANT-GTPγS

$C_{18}H_{20}N_6O_{14}P_3S$  669.37

NM29593

Price On Application

**2'/3'-O-(N-Methylantraniloyl)-N6-methyl-adenosine-5'-triphosphate triethylammonium salt**

$C_{19}H_{25}N_6O_{14}P_3$  654.36 (free acid)

NM29548

Price On Application

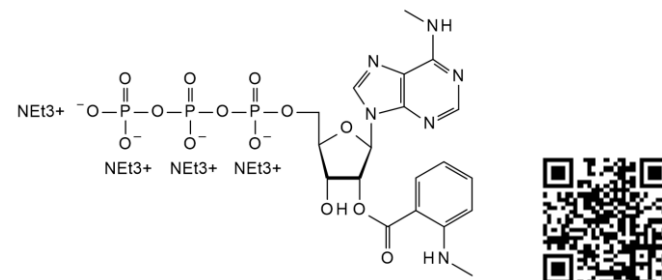
**N4-Methyl-5-azacytidine**

[27826-76-2]  $C_9H_{14}N_4O_5$  258.23

NM46062

Price On Application

**5'-(4-Methylbenzenesulfonate)**

see 5'-Tosyl-2'-deoxy cytidine, NT16566 on page 368

M

**2'-O-(N-Methylantraniloyl)-3'-deoxy-adenosine-5'-triphosphate triethylammonium salt**

• 2'-Mant-3'-dATP

[313378-46-0 (free acid)]  $C_{18}H_{23}N_6O_{13}P_3$  624.33 (free acid) Price On Application

NM29550

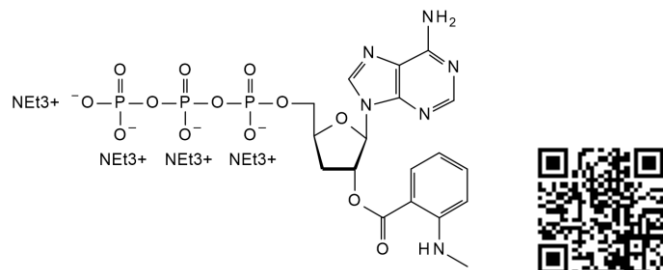
**3'-(N-Methyl-antraniloyl)-2'-deoxy-adenosine-5'-triphosphate triethylammonium salt**

[128113-53-1 (free acid)]  $C_{18}H_{23}N_6O_{13}P_3$  624.33 (free acid) Price On Application

NM29549

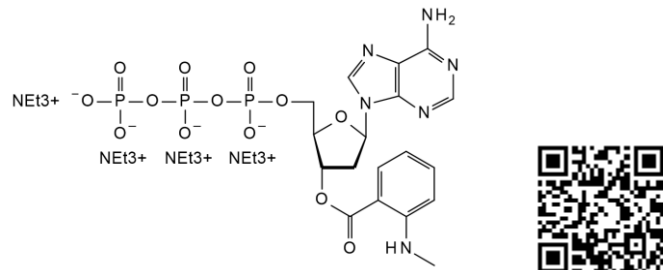

**Methyl 2-chloro-6-methylpyrimidine-4-carboxylate**

• 2-Chloro-6-methyl-pyrimidine-4-carboxylic acid methyl ester

[89793-11-3] C<sub>7</sub>H<sub>7</sub>ClN<sub>2</sub>O<sub>2</sub> 186.6

NM57398

1g	\$92.10
2g	\$147.40
5g	\$390.80

**b-Methylcrotonyl coenzyme A lithium salt**

[108347-83-7]

NM157477

50mg	\$1325.00
100mg	\$2100.00
250mg	\$4160.00

**5-Methyl-CTP**

see 5-Methylcytidine-5'-triphosphate sodium salt - 100mM aqueous solution, NM11441 on page 314

**2'-Methyl-cytidine-(Bz)-succinyl-CPG; 500 Å (RNA)**

NM11612

250mg	\$197.50
500mg	\$315.00
1g	\$525.00

**2'-C-Methylcytidine 5'-diphosphate triethylammonium salt**[640725-72-0 (free acid)] C<sub>10</sub>H<sub>17</sub>N<sub>3</sub>O<sub>11</sub>P<sub>2</sub> 417.2

NM29279

5mg	\$1025.00
10mg	\$1750.00

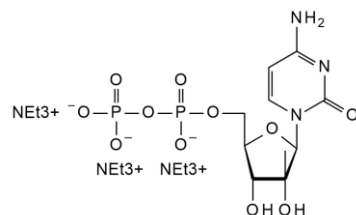
**5-Methylcytidine HCl**C<sub>10</sub>H<sub>15</sub>N<sub>3</sub>O<sub>5</sub>·HCl 293.71

NM08573

250mg	\$157.50
500mg	\$265.00
1g	\$472.50

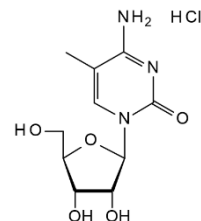
**N3-Methylcytidine methosulfate**[21028-20-6] C<sub>10</sub>H<sub>15</sub>N<sub>3</sub>O<sub>5</sub>·CH<sub>3</sub>SO<sub>4</sub> 369.35

NM02913

25mg	\$72.50
50mg	\$105.00
100mg	\$158.00

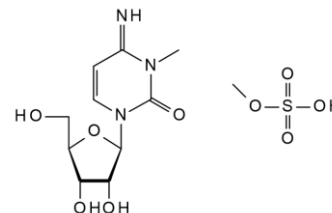
**5-Methylcytidine-5'-monophosphate**[3590-36-1] C<sub>10</sub>H<sub>16</sub>N<sub>3</sub>O<sub>6</sub>P 337.22

NM29555

25mg	\$656.50
50mg	\$997.50
100mg	\$1733.00

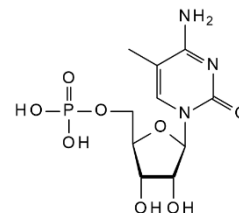

**Methylcytid****2'-O-Methylcytidine 5'-triphosphate lithium salt - 100mM aqueous solution**

## • 2'-O-Me-CTP

[143028-98-2 (free acid)]	$C_{10}H_{18}N_5O_{14}P_3 \cdot xLi$	497.18 (free acid basis)		
		1mg	\$95.00	
NM58210		2.5mg	\$200.00	
		5mg	\$295.00	

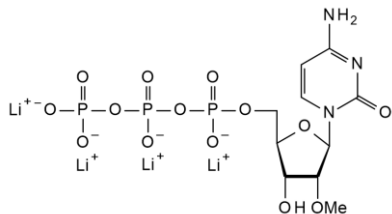
**2'-O-Methylcytidine-5'-triphosphate sodium salt - 100mM aqueous solution**

## • 2'OMe-CTP.Na

[143028-98-2 (free acid)]	$C_{10}H_{18}N_5O_{14}P_3 \cdot xNa$	497.18 (free acid basis)		
		2.5mg	\$150.00	
NM157273		5mg	\$250.00	
		10mg	\$390.00	

**5-Methylcytidine-5'-triphosphate sodium salt - 100mM aqueous solution**

## • 5-Methyl-CTP

[327174-86-7]	$C_{10}H_{18}N_5O_{14}P_3 \cdot xNa$	497.18 (free acid basis)		
		1mg	\$395.00	
NM11441		2mg	\$590.00	
		5mg	\$1375.00	

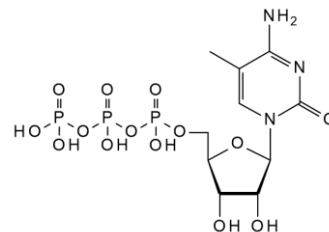
**2'-C-Methylcytidine 5'-triphosphate tetraTEA salt**

see 2'-C-Methylcytidine 5'-triphosphate triethylammonium salt - Aqueous Solution, NM29280 on page 314

**2'-C-Methylcytidine 5'-triphosphate triethylammonium salt - Aqueous Solution**

## • 2'-C-Methylcytidine 5'-triphosphate tetraTEA salt

[374750-28-4 (free acid)]	$C_{10}H_{18}N_5O_{14}P_3 \cdot 4C_6H_{15}N$	901.94		
		1mg	\$250.00	
NM29280		2mg	\$390.00	
		5mg	\$750.00	

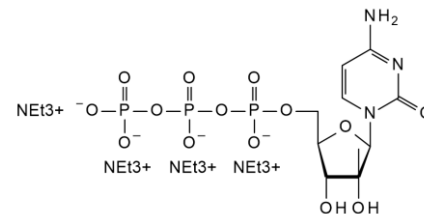

M

**3'-O-Methylcytidine 5'-triphosphate lithium salt**

## • 3'-OMeCTP

[69113-64-0 (free acid)]	$C_{10}H_{14}N_5O_{14}P_3 \cdot Li_4$	520.92		
		1mg	\$325.00	
NM46051		2mg	\$590.00	
		5mg	\$1300.00	

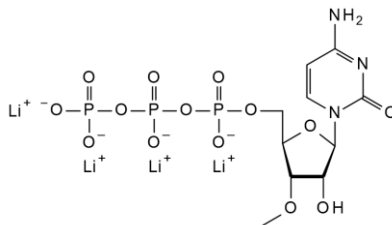
**5-Methylcytidine-5'-triphosphate lithium salt - 100 mM solution in H2O**

$C_{10}H_{18}N_5O_{14}P_3 \cdot xLi$	497.18 (free acid basis)		
		1mg	\$395.00
NM36295		2mg	\$590.00
		5mg	\$975.00



**N4-Methylcytidine 5'-triphosphate triethylammonium salt**

• N4-Me-CTP

C<sub>10</sub>H<sub>16</sub>N<sub>3</sub>O<sub>14</sub>P<sub>3</sub> 497.18

NM71657

Price On Application

**2'-C-Methylcytidine**[20724-73-6] C<sub>10</sub>H<sub>15</sub>N<sub>3</sub>O<sub>5</sub> 257.25

NM07918

100mg	\$60.00
250mg	\$100.00
500mg	\$175.00

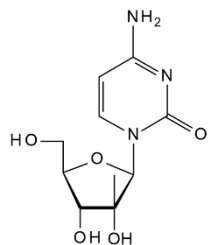
**2'-O-Methylcytidine**[2140-72-9] C<sub>10</sub>H<sub>15</sub>N<sub>3</sub>O<sub>5</sub> 257.24

NM06302

500mg	\$50.00
1g	\$80.00
2g	\$124.00

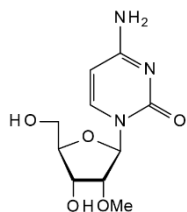

Refs: Inoue H, Hayase Y, Imura A, Iwai S, Miura K, Otsuka E, Nucleic Acids Res. 1987, Aug 11, 15(15), 6131-6148

**3'-O-Methylcytidine**[20594-00-7] C<sub>10</sub>H<sub>15</sub>N<sub>3</sub>O<sub>5</sub> 257.24

NM06229

10mg	\$42.00
25mg	\$79.00
50mg	\$121.00

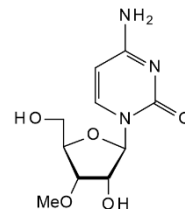
**5-Methylcytidine**[2140-61-6] C<sub>10</sub>H<sub>15</sub>N<sub>3</sub>O<sub>5</sub> 257.24

NM03720

500mg	\$70.00
1g	\$110.00
2g	\$180.00

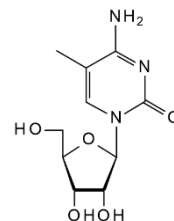
**N3-Methylcytidine**[2140-64-9] C<sub>10</sub>H<sub>15</sub>N<sub>3</sub>O<sub>5</sub> 257.24

NM05757

5mg	\$90.00
10mg	\$155.00
25mg	\$225.00

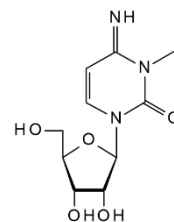

**Methylcytidi****N4-Methylcytidine**[10578-79-7] C<sub>10</sub>H<sub>15</sub>N<sub>3</sub>O<sub>5</sub> 257.24

NM76577

10mg	\$68.00
25mg	\$140.00
50mg	\$225.00

**5-Methyl-dCTP**

see 2'-Deoxy-5-methylcytidine-5'-triphosphate sodium salt - 10 mM aqueous solution, ND71642 on page 214

**N4-Methyl-dCTP**

see 2'-Deoxy-N4-methylcytidine 5'-triphosphate lithium salt - 100 mM aqueous solution, ND71658 on page 214

**N4-Methyldeoxycytidine**

see 2'-Deoxy-N4-methylcytidine, ND153424 on page 214

**O6-Methyl-2'-deoxyguanosine**

see 2'-Deoxy-6-O-methyl-guanosine, ND157121 on page 215

**5-Methyl-2'-deoxyisocytidine**

see 2'-Deoxy-5-methylisocytidine, ND144597 on page 216

**3-Methyl-8-(2-deoxy-b-D-ribofuranosyl)isoxanthopterin**[170379-51-8] C<sub>12</sub>H<sub>15</sub>N<sub>5</sub>O<sub>5</sub> 309.28

NM04903

1mg	\$160.00
2mg	\$290.00
5mg	\$675.00

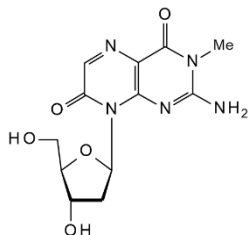

Refs: Wojtuszewski K, Hawkins ME, Cole JL, Mukerj I, Biochemistry 2001, 40(8), 2588 -2598

**6-Methyl-3-(b-D-2-deoxyribofuranosyl)pyrrolo[2,3-d]pyrimidin-2-one**

see N-Pyrrolo-2'-deoxycytidine, NP08698 on page 348

**5-Methyl-3'-deoxyuridine**

see 3'-Deoxy-5-methyluridine, ND02776 on page 217

**2'-O-Methyl-2,6-diaminopurine riboside**

see 2,6-Diamino-9-(2'-O-methyl-b-D-ribofuranosyl)purine, ND08564 on page 231

**Methyl 2,4-dimethoxypyrimidine-5-carboxylate**

[15400-58-5]

NM44304

Price On Application

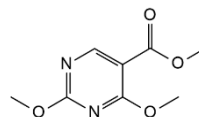
**5-Methyl-5'-O-DMT-deoxycytidine**

see 2'-Deoxy-5'-O-DMT-5-methylcytidine, ND08559 on page 187

**2'-O-Methyl-5'-O-DMT-D-guanosine**

see 5'-O-DMT-2'-O-methylguanosine, ND08420 on page 260

**2'-O-Methyl-5'-O-DMT-5-methyluridine**

see 5'-O-DMT-2'-O-methyl-5-methyluridine, ND08567 on page 260

**a,b-Methyleneguanosine 5'-diphosphate sodium salt**

• GMPCP

[161308-39-0] C<sub>11</sub>H<sub>17</sub>N<sub>5</sub>O<sub>10</sub>P<sub>2</sub>·xNa 441.23 (free acid basis)

NM46113

Price On Application





**1-(2'-O-4-C-Methylene-b-D-ribofuranosyl)guanine**

• LNA-G diol

[207131-16-6] C<sub>11</sub>H<sub>13</sub>N<sub>5</sub>O<sub>5</sub> 295.25

Price On Application

NM08152

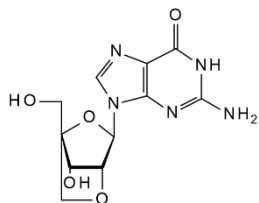
**3'-O-[(1-Methylethylidene)amino]-thymidine 5'-(tetrahydrogen triphosphate)**

see 3'-O-[(Propan-2-ylidene)amino]-thymidine 5'-triphosphate, NP145591 on page 343

**1-[2,3-O-(1-Methylethylidene)-b-D-ribofuranosyl]-1H-1,2,4-triazole-3-carboxylic acid methyl ester**

see 1-[2,3-O-Isopropylidene-b-D-ribofuranosyl]-1,2,4-triazole-3-carboxylic acid methyl ester, NI16557 on page 300

**N2-Methylguanosine-3',5'-cyclic monophosphate**

• 2-Me-cGMP

[205368-54-3] C<sub>11</sub>H<sub>13</sub>N<sub>5</sub>O<sub>7</sub>P·Na 381.21

Price On Application

NM46114

**2'-C-Methylguanosine 5'-diphosphate triethylammonium salt**C<sub>11</sub>H<sub>16</sub>N<sub>5</sub>O<sub>11</sub>P<sub>2</sub>·C<sub>18</sub>H<sub>45</sub>N<sub>3</sub> 759.79

NM10849

1mg	\$350.00
2mg	\$650.00
5mg	\$1250.00

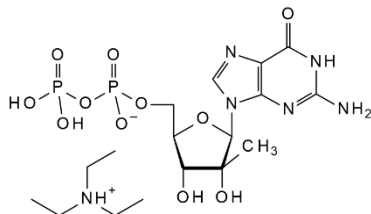
**2'-Methyl-guanosine-(iBu)-succinyl-CPG; 500 Å (RNA)**

NM11606

250mg	\$197.50
500mg	\$315.00
1g	\$525.00

**2'-C-Methylguanosine 5'-monophosphate triethyl ammonium salt - Aqueous solution**C<sub>11</sub>H<sub>16</sub>N<sub>5</sub>O<sub>8</sub>P·C<sub>12</sub>H<sub>32</sub>N<sub>2</sub> 581.64

NM09702

1mg	\$95.00
2mg	\$175.00
5mg	\$315.00

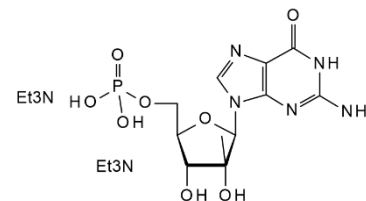
**2'-O-Methylguanosine 5'-monophosphate**

• 2'-O-Methyl-5'-guanylic acid

[24121-01-5] C<sub>11</sub>H<sub>16</sub>N<sub>5</sub>O<sub>8</sub>P 377.25

NM71636

Price On Application

**2'-O-Methylguanosine 5'-triphosphate lithium salt - 100mM aqueous solution**

• 2'-O-Me-GTP

[61556-44-3 (free acid)] C<sub>10</sub>H<sub>18</sub>N<sub>5</sub>O<sub>14</sub>P<sub>3</sub>·xLi 497.18 (free acid basis)

NM58211

1mg	\$95.00
2.5mg	\$200.00
5mg	\$295.00

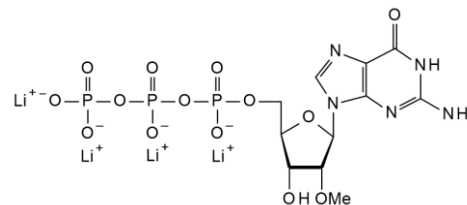

## Methylguanos

## 3'-O-Methylguanosine 5'-triphosphate lithium salt

[61556-45-4 (free acid)] C<sub>11</sub>H<sub>14</sub>N<sub>5</sub>O<sub>14</sub>P<sub>3</sub>·Li<sub>4</sub> 560.94

NM46052

1mg	\$325.00
2mg	\$590.00
5mg	\$1300.00

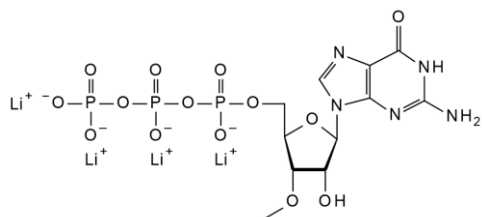

## 2'-O-Methylguanosine-5'-triphosphate sodium salt - 100mM aqueous solution

• 2'OMe-GTP.Na

[61556-44-3 (free acid)] C<sub>10</sub>H<sub>18</sub>N<sub>5</sub>O<sub>14</sub>P<sub>3</sub>·Na 520.17

NM157274

2.5mg	\$150.00
5mg	\$250.00
10mg	\$390.00



## 2'-C-Methylguanosine 5'-triphosphate triethyl ammonium salt - Aqueous solution

C<sub>11</sub>H<sub>18</sub>N<sub>5</sub>O<sub>14</sub>P<sub>3</sub>·4C<sub>6</sub>H<sub>15</sub>N 941.97

NM08170

1mg	\$195.00
2mg	\$350.00
5mg	\$625.00

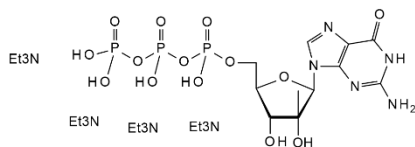

## 2'-C-Methylguanosine

• 2'-C-MeG

[374750-30-8] C<sub>11</sub>H<sub>15</sub>N<sub>5</sub>O<sub>5</sub> 297.27

NM07819

100mg	\$84.00
200mg	\$106.00
500mg	\$160.00

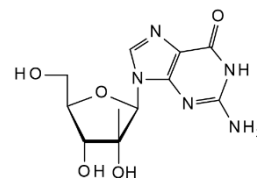

## 2'-O-Methylguanosine

[2140-71-8] C<sub>11</sub>H<sub>15</sub>N<sub>5</sub>O<sub>5</sub> 297.27

NM02941

500mg	\$60.00
1g	\$95.00
2g	\$170.00

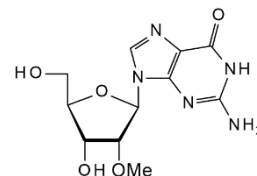

## 3'-O-Methylguanosine

[10300-27-3] C<sub>11</sub>H<sub>15</sub>N<sub>5</sub>O<sub>5</sub> 297.27

NM06232

10mg	\$60.00
25mg	\$100.00
50mg	\$162.50

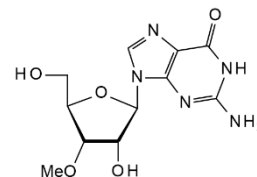

**N1-Methylguanosine**[2140-65-0] C<sub>11</sub>H<sub>15</sub>N<sub>5</sub>O<sub>5</sub> 297.27

NM08574

5mg	\$60.00
10mg	\$85.00
25mg	\$162.50

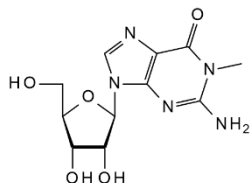
**N2-Methylguanosine**

• m2G

[2140-77-4] C<sub>11</sub>H<sub>15</sub>N<sub>5</sub>O<sub>5</sub> 297.27

NM35522

1mg	\$95.00
2mg	\$150.00
5mg	\$300.00

**N7-Methylguanosine**[20244-86-4] C<sub>11</sub>H<sub>15</sub>N<sub>5</sub>O<sub>5</sub> 297.27

NM08037

100mg	\$75.00
250mg	\$135.00
500mg	\$240.00

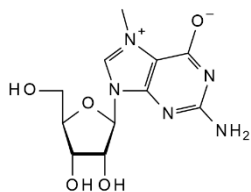
**O6-Methylguanosine**[7803-88-5] C<sub>11</sub>H<sub>15</sub>N<sub>5</sub>O<sub>5</sub> 297.27

NM02922

100mg	\$55.00
250mg	\$90.00
500mg	\$160.00

**2'-O-Methyl-5'-guanylic acid**

see 2'-O-Methylguanosine 5'-monophosphate, NM71636 on page 317

**5-Methyl-iC**

see 2'-Deoxy-5-methyl-isocytidine, ND76392 on page 215

**2'-C-Methylinosine**[374750-32-0] C<sub>11</sub>H<sub>14</sub>N<sub>4</sub>O<sub>5</sub> 282.25

NM14098

100mg	\$95.00
250mg	\$185.00
500mg	\$265.00

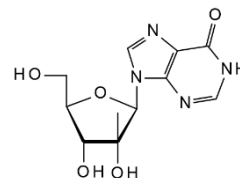
**2'-O-Methylinosine**[3881-21-8] C<sub>11</sub>H<sub>14</sub>N<sub>4</sub>O<sub>5</sub> 282.25

NM05162

200mg	\$42.00
500mg	\$95.00
1g	\$183.80

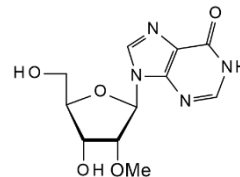
**3'-O-Methylinosine**[75479-64-0] C<sub>11</sub>H<sub>14</sub>N<sub>4</sub>O<sub>5</sub> 282.25

NM01973

5mg	\$99.80
10mg	\$189.00
25mg	\$315.00

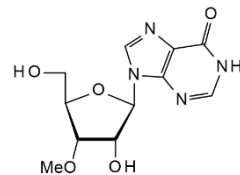

Refs: Broom AD, Robins RK, J. Am. Chem. Soc. 1965, p1145

**Methylmercap****2-Methylmercapto-4-oxo-6-aminopyrimidine monohydrate**

• 6-Amino-4-keto-2-methylmercaptopyrimidine

[220458-89-9] C<sub>5</sub>H<sub>7</sub>N<sub>3</sub>OS·H<sub>2</sub>O 175.21

NM70420

Price On Application

**2'-O-Methyl-5-methylcytidine**[113886-70-7] C<sub>11</sub>H<sub>17</sub>N<sub>3</sub>O<sub>5</sub> 271.27

NM06424

250mg	\$75.00
500mg	\$125.00
1g	\$195.00

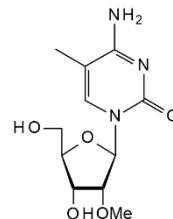
**6-Methylmercapto-9-(b-D-ribofuranosyl)purine-5'-triphosphate**

see 6-Methylthioinosine-5'-triphosphate sodium salt - 10 mM aqueous solution, NM71743 on page 325

M

**6-Methylmercapto-9-(b-D-ribofuranosyl)purine**[342-69-8] C<sub>11</sub>H<sub>14</sub>N<sub>4</sub>O<sub>4</sub>S 298.32

NM06304

100mg	\$60.00
250mg	\$100.00
500mg	\$150.00

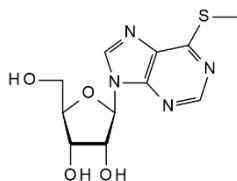
**3'-O-Methyl-5-methylcytidine**C<sub>11</sub>H<sub>17</sub>N<sub>3</sub>O<sub>5</sub> 271.27

NM00313

2mg	\$80.00
5mg	\$150.00
10mg	\$220.00

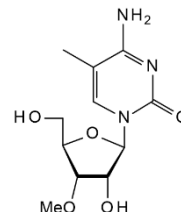
**N6-Methyl-2'-O-methyladenosine 5'-monophosphate**

NM157482

Price On Application

**5-O-[[[(1S)-1-Methyl-2-(1-methylethoxy)-2-oxoethyl]amino]-phenoxyphosphinyl]-cytidine**[946511-29-1] C<sub>21</sub>H<sub>29</sub>N<sub>4</sub>O<sub>9</sub>P 512.45

NM46513

1mg	\$350.00
2mg	\$590.00
5mg	\$1250.00

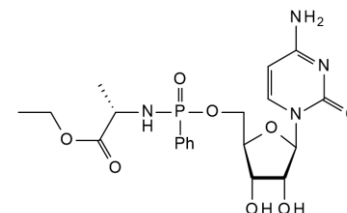
**N6-Methyl-2'-O-methyladenosine**

[57817-83-1]

NM157460

50mg	\$625.00
100mg	\$950.00
250mg	\$1750.00



**5-Methyl-7-(2-C-methyl-b-D-ribofuranosyl)-7H-pyrrolo[2,3-d]pyrimidin-4-amine**

[443642-53-3]

Price On Application

NM14093

**4-Methyl-2-(methylsulfanyl)-5-pyrimidinecarboxylic acid**[98276-75-6] C<sub>7</sub>H<sub>8</sub>N<sub>2</sub>O<sub>2</sub>S 184.22

NM57401

250mg	\$70.00
500mg	\$110.00
1g	\$213.90

**2'-C-Methyl-6-S-methyl-6-thioinosine**

[172722-76-8]

Price On Application

NM14097

**2'-O-Methyl-5-methyluridine**[114952-97-5][55486-09-4] C<sub>11</sub>H<sub>16</sub>N<sub>2</sub>O<sub>6</sub> 272.25

NM01238

1g	\$85.00
2g	\$150.00
5g	\$250.00

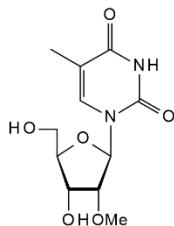
**3-Methyl-2-nitropyridine**

• 2-Nitro-3-picoline

[18368-73-5] C<sub>6</sub>H<sub>6</sub>N<sub>2</sub>O<sub>2</sub> 138.12

NM67852

1g	\$48.00
2g	\$84.00
5g	\$145.00

**2'-O-Methyl-N6-phenoxyacetyladenosine**C<sub>19</sub>H<sub>21</sub>N<sub>5</sub>O<sub>6</sub> 415.41

NM08427

10mg	\$63.00
25mg	\$105.00
50mg	\$184.00

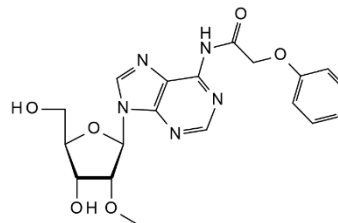
**2-Methyl-6-(phenylethynyl)pyridine**

• MPEP

[96206-92-7] C<sub>14</sub>H<sub>11</sub>N 193.24

NM66689

10mg	\$50.00
25mg	\$112.50
50mg	\$200.00

**2-(2-Methylphenyl)pyrimidine-5-carbaldehyde**[876710-73-5] C<sub>12</sub>H<sub>10</sub>N<sub>2</sub>O 198.22

NM57445

1g	\$81.40
2g	\$130.10
5g	\$323.00



## Methylphenyl

## 2-(3-Methylphenyl)pyrimidine-5-carbaldehyde

198.22

NM57435

2g	\$89.20
5g	\$195.50
10g	\$312.70



## 4-Methyl-6-phenyl-pyrimidine-2-thiol

[27955-44-8] C<sub>11</sub>H<sub>10</sub>N<sub>2</sub>S 202.28

NM57414

250mg	\$70.00
500mg	\$110.00
1g	\$267.30



## 4-(4-Methylphenyl)-2-pyrimidinethiol

[477859-71-5] 202.28

NM57409

500mg	\$90.00
1g	\$218.40
2g	\$349.40



## 6-[(4-Methylphenyl)thio]-2-oxo-9-(2',3',5'-tri-O-acetyl-b-D-ribofuranosyl)-2,3-dihydropurine

C<sub>23</sub>H<sub>24</sub>N<sub>4</sub>O<sub>6</sub>S 516.52

NM07256

100mg	\$105.00
250mg	\$197.50
500mg	\$315.00

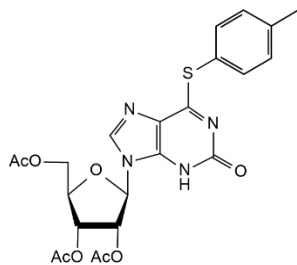

## 2'-O-Methyl-5-propynylcytidine

C<sub>13</sub>H<sub>17</sub>N<sub>3</sub>O<sub>5</sub> 295.29

NM06210

1mg	\$75.00
2mg	\$120.00
5mg	\$225.00

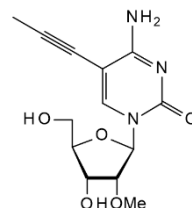

## 2'-O-Methyl-5-propynyluridine

C<sub>13</sub>H<sub>16</sub>N<sub>2</sub>O<sub>6</sub> 296.28

NM06235

5mg	\$150.00
10mg	\$275.00
20mg	\$500.00

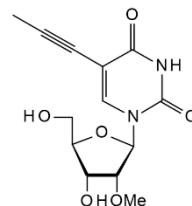

## 1-Methylpseudouridine

• 1-Methyl-5-b-D-ribofuranosyl-2,4(1H,3H)-pyrimidinedione

[13860-38-3] C<sub>10</sub>H<sub>14</sub>N<sub>2</sub>O<sub>6</sub> 258.23

NM35520

1mg	\$60.00
2mg	\$100.00
5mg	\$175.00

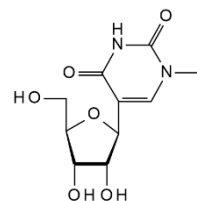

**2'-O-Methylpseudouridine**

NM02939	25mg	\$4900.00
	100mg	\$6520.00

**1-(2-C-b-Methyl-b-D-ribofuranosyl)-5-nitropyridine-2(1H)-one**

NM144522	Price On Application
----------	----------------------

**6-Methylpurine-2'-deoxyriboside**

[16006-64-7]	C <sub>11</sub> H <sub>14</sub> N <sub>4</sub> O <sub>3</sub>	250.25	
NM46495	1mg	\$75.00	
	2mg	\$120.00	
	5mg	\$250.00	

**9-(2-C-Methyl-b-D-ribofuranosyl)purine**

[690269-86-4]	C <sub>11</sub> H <sub>14</sub> N <sub>4</sub> O <sub>4</sub>	266.25	
NM144529	Price On Application		

**Methyl 4-pyrimidine carboxylate**

see *Pyrimidine-4-carboxylic acid methyl ester, NP57387 on page 347*

**1-Methyl-5-b-D-ribofuranosyl-2,4(1H,3H)-pyrimidinedione**

see *1-Methylpseudouridine, NM35520 on page 322*

**6-Methylpyrimidin-4-ol**

see *4-Hydroxy-6-methylpyrimidine, NH66985 on page 290*

**7-(2-C-Methyl-b-D-ribofuranosyl)-7H-pyrrolo[2,3-d]pyrimidin-2-amine**

[443642-48-6]		
NM14094	Price On Application	

**6-Methyl-4(3H)-pyrimidinone**

see *4-Hydroxy-6-methylpyrimidine, NH66985 on page 290*

**9-(5'-Methyl-b-D-ribofuranosyl)-6-chloropurine**

• 6-Chloropurine-9-(5-methyl-beta-D-ribofuranoside)

NM144826	Price On Application
----------	----------------------

**1-(2-C-Methyl-b-D-ribofuranosyl)-1H-1,2,4-triazole-3-carboxamide**

[847651-91-6]		
NM14086	500mg	\$4000.00



**Methylsulfan****2-Methylsulfanyl-4-phenylamino-pyrimidine-5-carbaldehyde**[211245-56-6] C<sub>12</sub>H<sub>11</sub>N<sub>3</sub>OS 245.3

NM57378

250mg	\$87.50
500mg	\$140.00
1g	\$334.70

**2-Methylsulfanyl-4-phenylpyrimidine**

NM44261

50mg	\$92.00
100mg	\$147.00
250mg	\$235.00

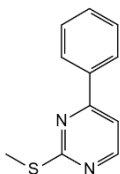
**2-Methylthioadenosine 5-monophosphate**[22140-20-1] C<sub>11</sub>H<sub>16</sub>N<sub>5</sub>O<sub>7</sub>PS 393.31

NM10203

1mg	\$500.00
2mg	\$600.00
5mg	\$700.00

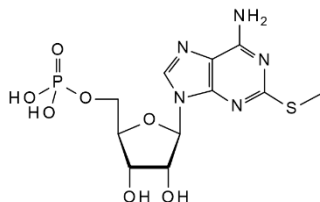
**2-Methylthioadenosine-5'-triphosphate**

• 2-MeS-ATP

[43170-89-4] C<sub>11</sub>H<sub>18</sub>N<sub>5</sub>O<sub>13</sub>P<sub>3</sub>S 553.27

NM72044

1mg	\$75.00
2mg	\$120.00
5mg	\$195.00

**2-Methylthioadenosine**[4105-39-9] C<sub>11</sub>H<sub>15</sub>N<sub>5</sub>O<sub>4</sub>S 313.34

NM09610

1mg	\$95.00
2mg	\$150.00
5mg	\$300.00

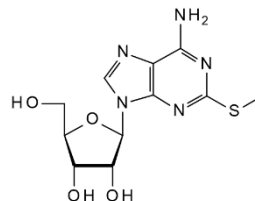

Refs: Zimmerman et.al, Biochemistry 1980, 19, p2252; Ou et.al, Biochem J, 2007, 401, p87

**2-Methylthio-6-chloro-9-methylpurine**[40423-35-6] C<sub>7</sub>H<sub>7</sub>ClN<sub>4</sub>S 318.14

NM29027

Price On Application

**2-Methylthio-6-chloropurine riboside**[66212-83-7] C<sub>12</sub>H<sub>15</sub>ClN<sub>4</sub>O<sub>5</sub>S 466.25

NM29026

Price On Application

**2-Methylthio-6-chloropurine**[66191-23-9] C<sub>8</sub>H<sub>5</sub>ClN<sub>4</sub>S 304.11

NM29024

Price On Application

**2-methylthio-6-(3,3-dimethylallylamino)-9-b-D-ribofuranosylpurine**see 2-Methylthio-N<sup>6</sup>-isopentenyladenosine, NM30233 on page 325

M



**6-Methylthio-GTP**

see 6-Methylthioguanosine-5'-triphosphate sodium salt - 10 mM aqueous solution, NM71742 on page 325

**7-Methyl-6-thioguanosine inner salt**

- MESH
- 2-Amino-6-mercapto-7-methylpurine ribonucleoside

[55727-10-1] C<sub>11</sub>H<sub>15</sub>N<sub>5</sub>O<sub>4</sub>S 313.33

NM06560 2mg \$130.00  
5mg \$262.50  
10mg \$472.50

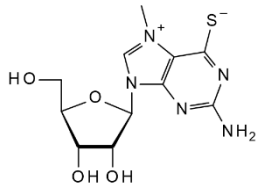

Refs: Webb MR, Proc. Nat. Acad. Sci. 1982, 89, p4884

**6-Methylthioguanosine-5'-triphosphate sodium salt - 10 mM aqueous solution**

- 6-Methylthio-GTP

[70318-62-6] C<sub>11</sub>H<sub>18</sub>N<sub>5</sub>O<sub>13</sub>P<sub>3</sub>S·xNa 553.27 (free acid basis)

NM71742 0.5mg \$215.00  
1mg \$390.00  
2.5mg \$625.00

**6-Methyl-thio-guanosine**

[4914-73-2] C<sub>11</sub>H<sub>15</sub>N<sub>5</sub>O<sub>4</sub>S 313.33

NM46468 25mg \$250.00  
50mg \$375.00  
100mg \$600.00

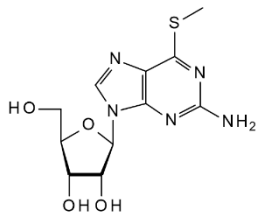
**6-Methylthioinosine-5'-triphosphate sodium salt - 10 mM aqueous solution**

- 6-Methylthio-ITP
- 6-Methylmercapto-9-(β-D-ribofuranosyl)purine-5'-triphosphate

[51464-82-5] C<sub>11</sub>H<sub>17</sub>N<sub>4</sub>O<sub>13</sub>P<sub>3</sub>S 538.26

NM71743

Price On Application

**2-Methylthio-N6-isopentenyladenosine**

- 2-methylthio-6-(3,3-dimethylallylamino)-9-β-D-ribofuranosylpurine

[20859-00-1] C<sub>16</sub>H<sub>23</sub>N<sub>5</sub>O<sub>4</sub>S 381.45

NM30233 1mg \$295.00  
2mg \$500.00  
5mg \$925.00

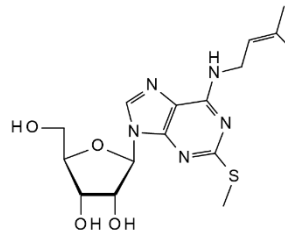
**6-Methylthio-ITP**

see 6-Methylthioinosine-5'-triphosphate sodium salt - 10 mM aqueous solution, NM71743 on page 325

**2-(Methylthio)-4-(P-Tolylamino)Pyrimidine-5-Carboxylic Acid**

[1033194-60-3] C<sub>13</sub>H<sub>13</sub>N<sub>3</sub>O<sub>2</sub>S 275.33

NM57392 25mg \$93.00  
50mg \$181.00  
100mg \$290.00



**Methylthiour****5-Methyl-2-thiouridine**[32738-09-3] C<sub>10</sub>H<sub>14</sub>N<sub>2</sub>O<sub>5</sub>S 274.29

NM08039

1mg	\$65.00
2mg	\$110.00
5mg	\$210.00

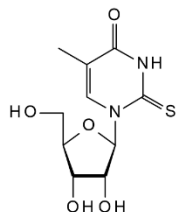
**N3-Methylthymidine**[958-74-7] C<sub>11</sub>H<sub>16</sub>N<sub>2</sub>O<sub>5</sub> 256.26

NM06239

5mg	\$47.30
10mg	\$84.00
25mg	\$147.00

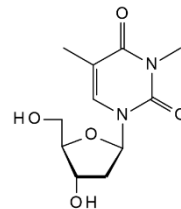
**5'-O-Methyl-D3-thymidine**C<sub>11</sub>H<sub>13</sub>N<sub>2</sub>O<sub>5</sub>D<sub>3</sub> 259.27

NM08850

Price On Application

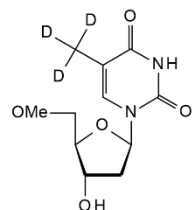
**5-Methyl-1-(5-tritylmethyl-2,5-dihydro-furan-2-yl)-1H-pyrimidine-2,4-dione**

see 2',3'-Dehydro-5'-O-tritylthymidine, ND04743 on page 171

**2'-C-Methyluridine 5'-triphosphate lithium salt - 10mM aqueous solution**C<sub>10</sub>H<sub>13</sub>N<sub>2</sub>O<sub>15</sub>P<sub>3</sub>Li<sub>4</sub> 521.9

NM106396

10mg	\$5500.00
------	-----------

**5'-O-Methylthymidine**[14504-60-0] C<sub>11</sub>H<sub>16</sub>N<sub>2</sub>O<sub>5</sub> 256.26

NM06451

25mg	\$125.00
50mg	\$200.00
100mg	\$336.00

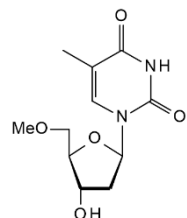
**2'-O-Methyluridine-5'-triphosphate lithium salt - 100mM aqueous solution**

• 2'-O-Me-UTP

[444789-43-9 (free acid)] C<sub>10</sub>H<sub>17</sub>N<sub>2</sub>O<sub>15</sub>P<sub>3</sub>·xLi 512.17 (free acid basis)

NM58212

1mg	\$95.00
2.5mg	\$200.00
5mg	\$295.00

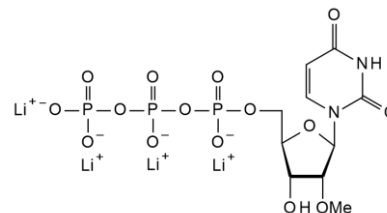

**3'-O-Methyluridine-5'-triphosphate lithium salt**[69113-65-1 (free acid)] C<sub>10</sub>H<sub>13</sub>N<sub>2</sub>O<sub>15</sub>P<sub>3</sub>·Li<sub>4</sub> 521.9

NM46053

1mg	\$325.00
2mg	\$590.00
5mg	\$1300.00

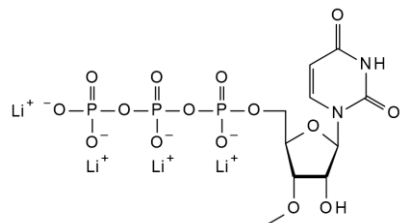
**2'-O-Methyluridine**[2140-76-3] C<sub>10</sub>H<sub>14</sub>N<sub>2</sub>O<sub>6</sub> 258.23

NM04259

2g	\$60.00
5g	\$95.00
10g	\$150.00

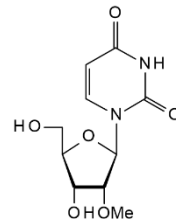

Refs: Inoue H, Hayase Y, Imura A, Iwai S, Miura K, Otsuka E, Nucleic Acids Res. 1987, Aug 11, 15(15), 6131-6148

**2'-O-Methyluridine-5'-triphosphate sodium salt - 100mM aqueous solution**

• 2'OMe-UTP.Na

[444789-43-9 (free acid)] C<sub>10</sub>H<sub>17</sub>N<sub>2</sub>O<sub>15</sub>P<sub>3</sub>·xNa 498.17 (free acid basis)

NM157271

2.5mg	\$150.00
5mg	\$250.00
10mg	\$390.00

**3'-O-Methyluridine**[6038-59-1] C<sub>10</sub>H<sub>14</sub>N<sub>2</sub>O<sub>6</sub> 258.23

NM06248

25mg	\$63.00
50mg	\$94.50
100mg	\$184.00

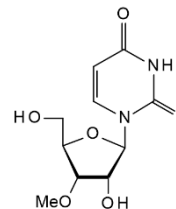
**2'-C-Methyluridine**[31448-54-1] C<sub>10</sub>H<sub>14</sub>N<sub>2</sub>O<sub>6</sub> 258.23

NM07919

250mg	\$60.00
500mg	\$95.00
1g	\$170.00

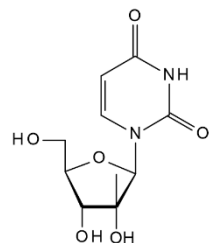
**5-Methyl-L-uridine**[26879-47-0] C<sub>10</sub>H<sub>14</sub>N<sub>2</sub>O<sub>6</sub> 258.23

NM06240

5mg	\$84.00
10mg	\$157.50
25mg	\$262.50

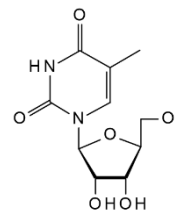

**Methyluridin****5-Methyluridine**[1463-10-1] C<sub>10</sub>H<sub>14</sub>N<sub>2</sub>O<sub>6</sub> 258.23

NM04922

50g	\$65.00
100g	\$85.00
250g	\$140.00

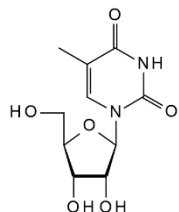

Refs: An H, Wang T, Maier MA, Manoharan M, Ross BS, J. Org. Chem. 2001, 66, p2789

**6-Methyluridine**[16710-13-7] C<sub>10</sub>H<sub>14</sub>N<sub>2</sub>O<sub>6</sub> 258.23

NM08576

5mg	\$115.00
10mg	\$195.00
25mg	\$400.00

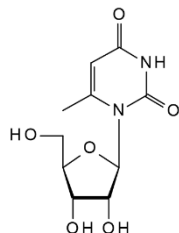
**L-5-methyluridine**

178.23

NM57493

Price On Application

**N3-Methyluridine**[2140-69-4] C<sub>10</sub>H<sub>14</sub>N<sub>2</sub>O<sub>6</sub> 258.23

NM06185

10mg	\$60.00
25mg	\$107.50
50mg	\$175.00

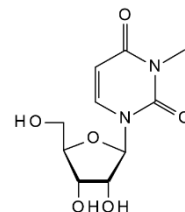
**9-(3'-O-Methyl-b-D-xylofuranosyl)adenine**

NM137577

Price On Application

**1-(3'-O-Methyl-b-D-xylofuranosyl)cytosine**

NM137575

Price On Application

**1-(3'-O-Methyl-b-D-xylofuranosyl)-5-methyluracil**

NM137573

Price On Application



**1-(3'-O-Methyl-b-D-xylofuranosyl)uracil**

NM137574

Price On Application

**N6-(4-Methoxybenzoyl)adenosine**

• PAC-rA

[56883-05-7] C<sub>18</sub>H<sub>19</sub>N<sub>5</sub>O<sub>6</sub> 401.37

NP57529

Price On Application

**2'-O-Me-UTP**

see 2'-O-Methyluridine-5'-triphosphate lithium salt - 100mM aqueous solution, NM58212 on page 326

**Mizoribine**

• 1-(β-D-Ribofuranosyl)-5-hydroxyimidazole-4-carboxamide

[50924-49-7] C<sub>9</sub>H<sub>13</sub>N<sub>3</sub>O<sub>6</sub> 259.22

NM09731

50mg	\$50.00
100mg	\$80.00
250mg	\$150.00

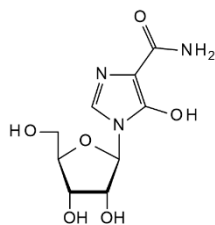
**5'-O-MMT-thymidine**C<sub>30</sub>H<sub>30</sub>N<sub>2</sub>O<sub>6</sub> 514.57

NM09057

Price On Application

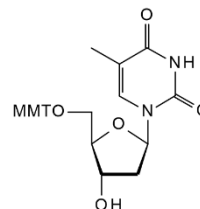
**2'-O-MOE-Guanosine**

see 2'-O-(2-Methoxyethyl)guanosine, NM57537 on page 306

**2'-O-MOE-T**

see 2'-O-(2-Methoxyethyl)-5-methyluridine, NM57538 on page 307

**MPEP**

see 2-Methyl-6-(phenylethynyl)pyridine, NM66689 on page 321

**MRE 0094**

see 2-[2-(4-Chlorophenyl)ethoxy]adenosine, NC16521 on page 150

**Myristoyl coenzyme A lithium salt**

• n-Tetradecanoyl coenzyme A lithium salt

[187100-75-0] C<sub>35</sub>H<sub>62</sub>N<sub>7</sub>O<sub>17</sub>P<sub>3</sub>S·xLi 977.89 (free acid basis)

NM63223	1mg	\$75.00
	2mg	\$130.00
	5mg	\$235.00



**Myristoylcoe****Myristoyl coenzyme A**

• n-Tetradecanoyl coenzyme A

[3130-72-1] C<sub>35</sub>H<sub>62</sub>N<sub>7</sub>O<sub>17</sub>P<sub>3</sub>S·H<sub>2</sub>O 995.91

NM47200

2mg	\$70.00
5mg	\$125.00
10mg	\$225.00

**b-NADH phosphate disodium salt**see *b-Nicotinamide adenine dinucleotide phosphate disodium salt, NN44916 on page 331***NADPH.4Na**see *b-Nicotinamide adenine dinucleotide phosphate, reduced form, tetrasodium salt - min 95%, NN10871 on page 332***NADPH-D**see *b-Nicotinamide-D adenine dinucleotide reduced form, NN11407 on page 333***b-NADP-K**see *b-Nicotinamide adenine dinucleotide phosphate potassium salt hydrate, NN11481 on page 331***b-NADP-sodium salt**see *b-Nicotinamide adenine dinucleotide phosphate sodium salt hydrate, NN11662 on page 332***a-NADP**see *a-Nicotinamide adenine dinucleotide phosphate, NN29116 on page 332***b-NADP**see *b-Nicotinamide adenine dinucleotide phosphate hydrate, NN45264 on page 331***b-NADs**see *b-Nicotinamide adenine dinucleotide sodium salt dihydrate, NN44827 on page 333***b-NAD**see *b-Nicotinamide adenine dinucleotide, NN11969 on page 333***2-[2-(2-Naphthalenyl)ethoxy]adenosine**• 2-[2-(2-Naphthylethoxy)adenosine]  
• WRC 0018[131865-99-1] C<sub>22</sub>H<sub>23</sub>N<sub>5</sub>O<sub>5</sub> 437.45

NN16559

25mg	\$140.00
50mg	\$254.50
100mg	\$462.00

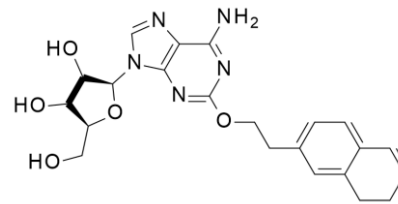

Refs: Matova, M, et al, Drug Des. Discov, 16, 255 (2000); Gao, Z, et al, Biochem. Pharmacol, 68, 1985 (2004)

**2-[2-(2-Naphthylethoxy)adenosine]**see *2-[2-(2-Naphthalenyl)ethoxy]adenosine, NN16559 on page 330***NBMPR**see *S-(4-Nitrobenzyl)-6-thioinosine, NN09410 on page 335***3'-O, N4-Diacetyl-2'-deoxycytidine**

• N4-Acetyl-3'-O-acetyl-2'-deoxycytidine

C<sub>13</sub>H<sub>17</sub>N<sub>3</sub>O<sub>6</sub> 311.29

ND09207

Price On Application

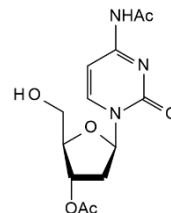
**Nebularine**see *9-(b-D-Ribofuranosyl)purine, NR05251 on page 351***Nebularin 5'-triphosphate**see *Purine riboside-5'-triphosphate, NP58309 on page 345***NECA**see *5'-Ethylcarboxamidoadenosine, NE06155 on page 270*

M

**Nelarabine**

- 9-β-D-Arabinofuranosyl-6-methoxy-9H-purin-2-amine
- 506u
- Arranon

[121032-29-9] C<sub>11</sub>H<sub>15</sub>N<sub>5</sub>O<sub>5</sub> 297.27

	50mg	\$125.00
NN26176	100mg	\$190.00
	250mg	\$325.00

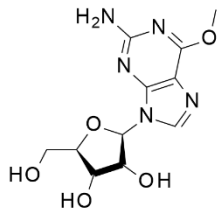

Refs: Cohen, M.H. et al. *Oncologist*, 13, 709 (2008); Hernandez-Illizaliturri, F.J. et al. *Clin. Med. Therap.*, 1, 505 (2009); Sigalas, P. et al. *Leuk. Res.*, 33, e61 (2009)

**Nevirapine**[129618-40-2] C<sub>15</sub>H<sub>14</sub>N<sub>4</sub>O 266.3

	100mg	\$105.00
NN15304	250mg	\$190.00
	500mg	\$300.00

**NGD**see *Nicotinamide guanine dinucleotide sodium salt*, NN46649 on page 334**b-Nicotinamide adenine dinucleotide phosphate disodium salt**

- b-NADH phosphate disodium salt

[24292-60-2] C<sub>21</sub>H<sub>26</sub>N<sub>7</sub>Na<sub>2</sub>O<sub>17</sub>P<sub>3</sub> 787.37

	1g	\$50.00
NN44916	2g	\$80.00
	5g	\$160.00

**b-Nicotinamide adenine dinucleotide phosphate hydrate**

- b-NADP

[53-59-8] C<sub>21</sub>H<sub>28</sub>N<sub>7</sub>O<sub>17</sub>P<sub>3</sub>·xH<sub>2</sub>O 743.41 (anhydrous basis)

	1g	\$75.00
NN45264	2g	\$110.00
	5g	\$175.00

**b-Nicotinamide adenine dinucleotide phosphate potassium salt hydrate**

- coenzyme II
- b-NADP-K
- Triphosphopyridine nucleotide potassium salt

[68141-45-7] C<sub>21</sub>H<sub>27</sub>KN<sub>7</sub>O<sub>17</sub>P<sub>3</sub> 781.5

	100mg	\$75.00
NN11481	250mg	\$125.00
	500mg	\$200.00

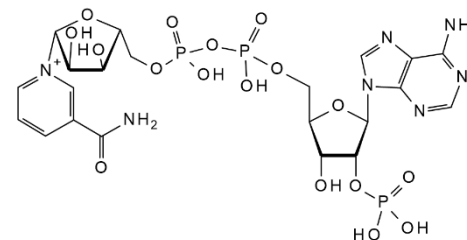
**b-Nicotinamide adenine dinucleotide phosphate, reduced form, disodium salt**C<sub>21</sub>H<sub>26</sub>N<sub>7</sub>O<sub>19</sub>P<sub>3</sub>·2Na 819.37

	250mg	\$105.00
NN10872	500mg	\$190.00
	1g	\$315.00

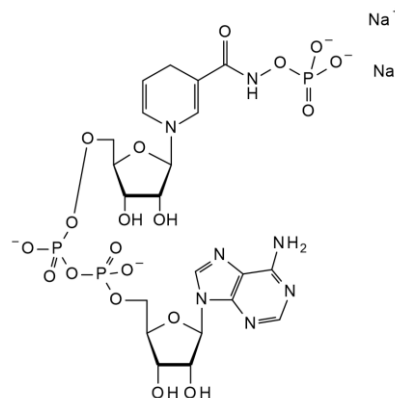

**Nicotinamide****b-Nicotinamide adenine dinucleotide phosphate, reduced form, tetrasodium salt - min 95%**

• NADPH.4Na

[2646-71-1] C<sub>21</sub>H<sub>26</sub>N<sub>7</sub>O<sub>17</sub>P<sub>3</sub>·4Na 833.36

	100mg	\$60.00
NN10871	250mg	\$110.00
	500mg	\$195.00

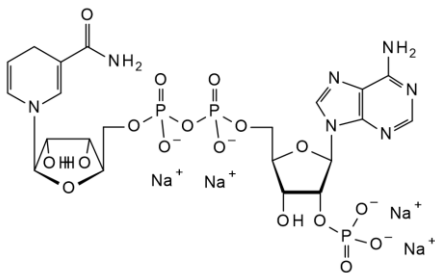

N

**b-Nicotinamide adenine dinucleotide 3'-phosphate sodium salt hydrate**[50443-29-3] C<sub>21</sub>H<sub>27</sub>N<sub>7</sub>O<sub>17</sub>P<sub>3</sub>·xNa·yH<sub>2</sub>O 742.40 (anhydrous free acid basis)

NN45265 Price On Application

**b-Nicotinamide adenine dinucleotide phosphate sodium salt hydrate**

• b-NADP-sodium salt

[1184-16-3][698999-85-8] C<sub>21</sub>H<sub>27</sub>N<sub>7</sub>NaO<sub>17</sub>P<sub>3</sub> 765.39

NN11662	1 g	\$50.00
	2g	\$90.00
	5 g	\$200.00

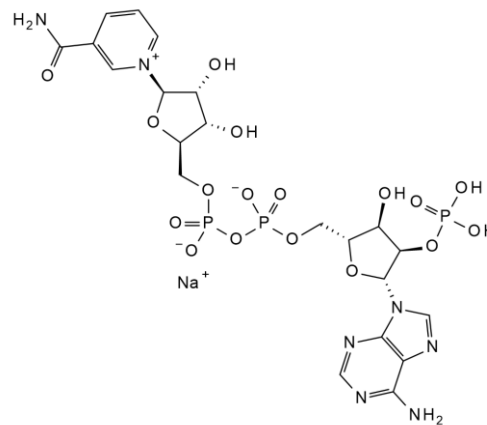
**a-Nicotinamide adenine dinucleotide phosphate**

• a-NADP

• a-Triphosphopyridine nucleotide

[108392-03-6] C<sub>21</sub>H<sub>26</sub>N<sub>7</sub>O<sub>17</sub>P<sub>3</sub> 743.41

NN29116

Price On Application





**b-Nicotinamide adenine dinucleotide reduced form, disodium salt**[606-68-8] C<sub>21</sub>H<sub>27</sub>N<sub>7</sub>O<sub>14</sub>P<sub>2</sub>·2Na 709.4

NN12622

2g	\$50.00
5g	\$85.00
10g	\$150.00

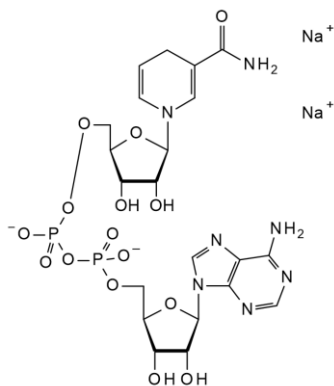
**b-Nicotinamide adenine dinucleotide sodium salt dihydrate**

- Coenzyme 1
- b-NADs
- Diphosphopyridine nucleotide

[20111-18-6] C<sub>21</sub>H<sub>26</sub>N<sub>7</sub>NaO<sub>14</sub>P<sub>2</sub>·2H<sub>2</sub>O 721.44

NN44827

2g	\$64.00
5g	\$115.00
10g	\$180.00

**b-Nicotinamide adenine dinucleotide**

- b-NAD
- Coenzyme 1
- Diphosphopyridine nucleotide

[53-84-9] C<sub>21</sub>H<sub>27</sub>N<sub>7</sub>O<sub>14</sub>P<sub>2</sub> 663.43

NN11969

2g	\$40.00
5g	\$80.00
10g	\$140.00

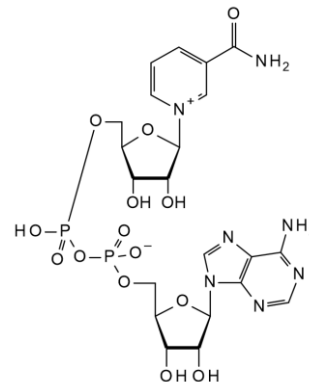
**b-Nicotinamide-D adenine dinucleotide reduced form**

- NADPH-D

[74784-45-5] C<sub>21</sub>H<sub>26</sub>N<sub>7</sub>O<sub>17</sub>P<sub>3</sub>D 746.43

NN11407

Price On Application

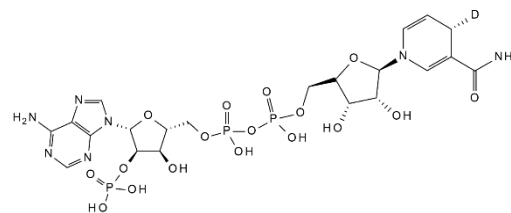

**Nicotinamide****Nicotinamide 1,N6-ethenoadenine dinucleotide**

- 3-(Aminocarbonyl)-1-[5-O-[hydroxy(phosphonoxy)phosphinyl]-b-D-ribofuranosyl]pyridinium inner salt P'5'-ester with 3-b-D-ribofuranosyl-3H-imidazo[2,1-i]purine
- 1,N6-Ethenonicotinamide adenine dinucleotide

[38806-38-1] C<sub>23</sub>H<sub>27</sub>N<sub>7</sub>O<sub>14</sub>P<sub>2</sub> 687.45

NN26196

2mg	\$139.90
5mg	\$254.40
10mg	\$462.50

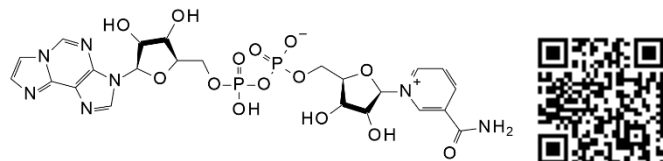

Refs: Gafni, A, et al,

**Nicotinamide ribose triflate**see *b-Nicotinamide riboside triflic acid salt*, NN15702 on page 334**Nicotinamide riboside bromide**

- 3-(Aminocarbonyl)-1-b-D-ribofuranosyl-pyridinium bromide

[78687-39-5] C<sub>11</sub>H<sub>15</sub>BrN<sub>2</sub>O<sub>5</sub> 335.15

NN31173

50mg	\$1200.00
100mg	\$1560.00
250mg	\$1950.00

**Nicotinamide guanine dinucleotide sodium salt**

- NGD

[5624-35-1] C<sub>21</sub>H<sub>28</sub>N<sub>7</sub>O<sub>15</sub>P<sub>2</sub>·xNa 680.43 (free acid basis)

NN46649

5mg	\$225.00
10mg	\$390.00
25mg	\$700.00

**b-Nicotinamide riboside chloride**

- 3-(Aminocarbonyl)-1-a-D-ribofuranosyl-pyridinium chloride

[23111-00-4] C<sub>11</sub>H<sub>15</sub>N<sub>2</sub>O<sub>5</sub>·Cl 290.7

NN45059

100mg	\$1560.00
250mg	\$1950.00
500mg	\$3250.00

**b-Nicotinamide mononucleotide**

- Nicotinamide ribonucleoside 5'-phosphate
- b-Nicotinamide ribose monophosphate

[1094-61-7] C<sub>11</sub>H<sub>15</sub>N<sub>2</sub>O<sub>8</sub>P 334.22

NN45555

10mg	\$50.00
25mg	\$75.00
50mg	\$125.00

**b-Nicotinamide riboside triflic acid salt**

- Nicotinamide ribose triflate
- Nicotinamide ribonucleoside trifluoromethanesulfonate

[445489-49-6][1341-23-7] C<sub>12</sub>H<sub>15</sub>F<sub>3</sub>N<sub>2</sub>O<sub>8</sub>S 404.32

NN15702

50mg	\$70.00
100mg	\$125.00
250mg	\$240.00

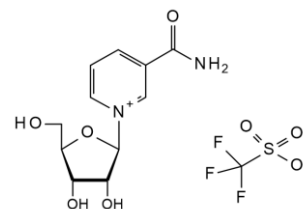
**Nicotinamide ribonucleoside 5'-phosphate**see *b-Nicotinamide mononucleotide*, NN45555 on page 334**Nicotinamide ribonucleoside trifluoromethanesulfonate**see *b-Nicotinamide riboside triflic acid salt*, NN15702 on page 334**b-Nicotinamide ribose monophosphate**see *b-Nicotinamide mononucleotide*, NN45555 on page 334

**Nicotinic acid riboside**

• 3-Carboxy-1-β-D-ribofuranosylpyridinium salt

[17720-18-2] C<sub>11</sub>H<sub>13</sub>NO<sub>6</sub> 255.22

NN16815

2mg	\$75.00
5mg	\$125.00
10mg	\$240.00

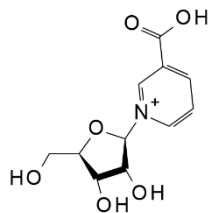

Refs: Yang, T. et al, J. Med. Chem, 50, 6458 (2007)

**S-(4-Nitrobenzyl)-6-thioinosine**• 6-[(4-Nitrobenzyl)thio]-9-β-D-ribofuranosylpurine  
• NBMPR[38048-32-7] C<sub>17</sub>H<sub>17</sub>N<sub>5</sub>O<sub>6</sub>S 419.41

NN09410

50mg	\$75.00
100mg	\$130.00
250mg	\$275.00

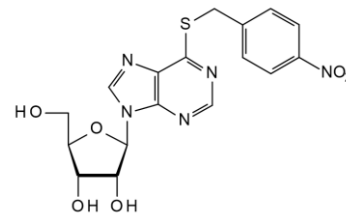
**4'-Nitrobenzoyl-6-selenoinosine**[40144-12-5] C<sub>17</sub>H<sub>15</sub>N<sub>5</sub>O<sub>7</sub>Se 480.29

NN08056

2mg	\$89.30
5mg	\$157.50
10mg	\$262.50

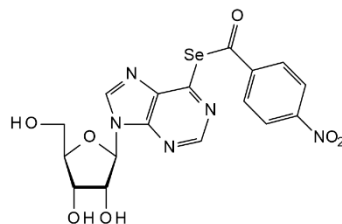
**6-[(4-Nitrobenzyl)thio]-9-(β-D-ribofuranosyl)purine-5'-monophosphate disodium salt**C<sub>17</sub>H<sub>16</sub>N<sub>5</sub>Na<sub>2</sub>O<sub>9</sub>PS 543.36

NN07313

1mg	\$90.00
2mg	\$150.00
5mg	\$262.50

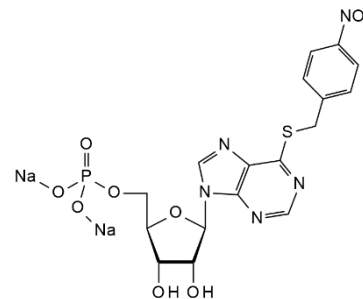

Refs: Paran JH, et al, Cancer Res, 41, p560

**S-(4-Nitrobenzyl)-6-thioguanosine**

• 2-Amino-6-[(4-nitrobenzyl)thio]-9-β-D-ribofuranosylpurine

[13153-27-0] C<sub>17</sub>H<sub>18</sub>N<sub>6</sub>O<sub>6</sub>S 434.43

NN09411

Price On Application

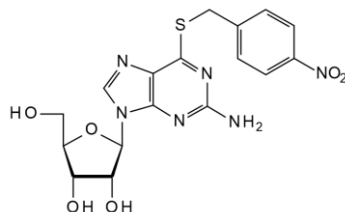
**6-[(4-Nitrobenzyl)thio]-9-β-D-ribofuranosylpurine**

see S-(4-Nitrobenzyl)-6-thioinosine, NN09410 on page 335

**8-Nitroguanosine**[337536-53-5] C<sub>10</sub>H<sub>12</sub>N<sub>6</sub>O<sub>7</sub> 328.24

NN03322

1mg	\$577.50
2mg	\$945.00
5mg	\$1575.00

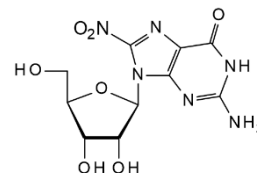

Refs: Masuda et al, Chem. Biol. Interact, 2002, 139, p187



**Nitrophenyle****P3-(1-(2-Nitrophenyl)ethyl) adenosine 5'-triphosphate disodium salt**

• Adenosine, 5'-(tetrahydrogen triphosphate), P<sup>3</sup>-(1-(2-nitrophenyl)ethyl) ester, disodium salt  
 • NPE-caged ATP

[171800-68-3] C<sub>18</sub>H<sub>21</sub>N<sub>6</sub>Na<sub>2</sub>O<sub>15</sub>P<sub>3</sub> 700.29

NN63886	1mg	\$160.00
	2mg	\$270.00
	5mg	\$450.00

**2-Nitro-3-picoline**

see 3-Methyl-2-nitropyridine, NM67852 on page 321

**3-(1-NM)-PPTP**

see 4-Amino-3-(1-naphthylmethyl)-1H-pyrazolo[3,4-d]pyrimidine-1-(β-D-ribofuranosyl-5'-triphosphate), NA16506 on page 59

**Nonadecanoyl coenzyme A**

[25045-61-8] C<sub>40</sub>H<sub>72</sub>N<sub>7</sub>O<sub>17</sub>P<sub>3</sub>S 1048.02

NN47201	5mg	\$125.00
	10mg	\$195.00
	20mg	\$340.00

**1-(3'-O-Nosyl-5'-O-trityl-2'-deoxy-β-D-lyxofuranosyl)thymine**

C<sub>35</sub>H<sub>31</sub>N<sub>3</sub>O<sub>6</sub>S 669.7

NN07310	25mg	\$89.50
	50mg	\$168.00
	100mg	\$263.00

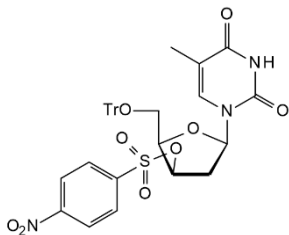
**Nourseothricin sulfate**

[96736-11-7] 1261.4

NN11350

50mg	\$72.00
100mg	\$120.00
250mg	\$190.00

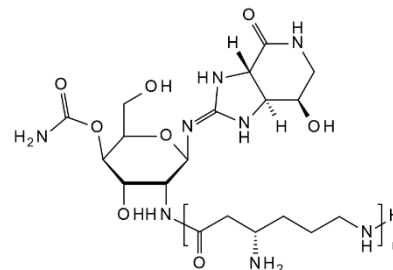
**NPE-caged ATP**

see P3-(1-(2-Nitrophenyl)ethyl) adenosine 5'-triphosphate disodium salt, NN63886 on page 336

**NSC 31144**

see 2-Chloro-6-O-methylinosine, NC16520 on page 149

**NSC 371796**

see AICAR 3',5'-cyclic phosphate, NA16501 on page 30

**Nucleocidin**

see 4'-C-Fluoroadenosine 5'-sulfamate, NF76155 on page 275

**Nucleoside Q**

see 7-(4,5-cis-Dihydro-a-[(methoxycarbonyl)amino]-4,6-dimethyl-9-oxo-3-β-D-ribofuranosyl-3H-Imidazo[1,2-a]purine-7-butanoic acid methyl ester, ND157876 on page 248

**Nucleoside Y**

see (S)-4,9-Dihydro-a-[(methoxycarbonyl)amino]-4,6-dimethyl-9-oxo-3-β-D-ribofuranosyl-3H-Imidazo[1,2-a]purine-7-butanoic acid methyl ester, ND157877 on page 247

**cis,cis-9,12-Octadecadienoyl coenzyme A**

see Linoleoyl coenzyme A, NL47198 on page 303

**n-Octadecanoyl coenzyme A**

see Stearoyl coenzyme A, NS47205 on page 354

**cis-9-Octadecenoyl coenzyme A potassium salt**

see Oleoyl coenzyme A potassium salt, NO63224 on page 337

N

**cis-9-Octadecenoyl coenzyme A**see *Oleoyle coenzyme A*, NO47203 on page 337**5-Octa-1,7-diylnyl-2'-deoxyuridine**[909398-18-1] C<sub>17</sub>H<sub>20</sub>N<sub>2</sub>O<sub>5</sub> 332.35

NO10556	1mg	\$94.50
	2mg	\$157.50
	5mg	\$262.50

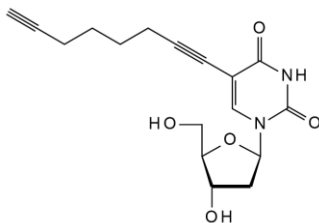
**Octanoyl coenzyme A**

• Caprylyl coenzyme A

[1264-52-4] C<sub>29</sub>H<sub>50</sub>N<sub>7</sub>O<sub>17</sub>P<sub>3</sub>S 893.73

NO47202	2mg	\$70.00
	5mg	\$120.00
	10mg	\$195.00

**N6-Octanoyl cordycepin**see *3'-Deoxy-N6-octanoyl adenosine*, ND10013 on page 217**N6-Octanoyl-3'-deoxyadenosine**see *3'-Deoxy-N6-octanoyl adenosine*, ND10013 on page 217**5'-O-(4,4'-Dimethoxytrityl)-N4-acetyl-2'-deoxycytidine**see *N4-Acetyl-5'-O-DMT-cytidine*, NA11105 on page 18**Oleoyle coenzyme A potassium salt**

• cis-9-Octadecenoyl coenzyme A potassium salt

[1716-06-9] C<sub>39</sub>H<sub>67</sub>N<sub>7</sub>O<sub>17</sub>P<sub>3</sub>SK 1070.07

NO63224	5mg	\$110.00
	10mg	\$190.00
	25mg	\$375.00

**Oleoyle coenzyme A**

• cis-9-Octadecenoyl coenzyme A

[1716-06-9] C<sub>39</sub>H<sub>68</sub>N<sub>7</sub>O<sub>17</sub>P<sub>3</sub>S 1031.98

NO47203	2mg	\$90.00
	5mg	\$162.50
	10mg	\$260.00

**2'OMe-ATP.Na**see *2'-O-Methyladenosine-5'-triphosphate sodium salt - 100mM aqueous solution*, NM157272 on page 309**2'OMe-CTP.Na**see *2'-O-Methylcytidine-5'-triphosphate sodium salt - 100mM aqueous solution*, NM157273 on page 314**3'-OMeCTP**see *3'-O-Methylcytidine 5'-triphosphate lithium salt*, NM46051 on page 314**2'OMe-GTP.Na**see *2'-O-Methylguanosine-5'-triphosphate sodium salt - 100mM aqueous solution*, NM157274 on page 318**5'-O-[bis(4-methoxyphenyl)phenylmethyl]-2'-deoxy-N-[(dimethylamino)methylene]-adenosine**see *2'-Deoxy-6N-DMF-5'-O-DMT-adenosine*, ND146470 on page 180**2'OMe-UTP.Na**see *2'-O-Methyluridine-5'-triphosphate sodium salt - 100mM aqueous solution*, NM157271 on page 327

**OMP****OMP**see *Orotidine 5'-monophosphate trisodium salt*, NO71879 on page 338**Orotidine 5'-monophosphate trisodium salt**

- Orotidylic acid
- OMP

[68244-58-6][2149-82-8] C<sub>10</sub>H<sub>10</sub>N<sub>2</sub>O<sub>11</sub>PNa<sub>3</sub> 434.14

NO71879

Price On Application

**Orotidine**

- Uridine-6-carboxylic acid

[314-50-1] C<sub>10</sub>H<sub>12</sub>N<sub>2</sub>O<sub>8</sub> 288.21

NO08048

1mg	\$200.00
2mg	\$300.00
5mg	\$600.00

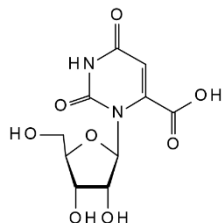
**Orotidylic acid**see *Orotidine 5'-monophosphate trisodium salt*, NO71879 on page 338**8-Oxo-dG**see *2'-Deoxy-8-oxoguanosine*, ND06344 on page 218**8-Oxoguanosine**

- 8-Hydroxy-D-guanosine

[3868-31-3] C<sub>10</sub>H<sub>13</sub>N<sub>5</sub>O<sub>6</sub> 299.24

NO05772

2mg	\$50.00
5mg	\$75.00
10mg	\$130.00

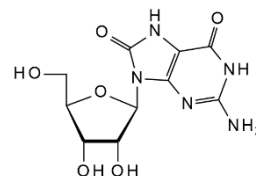

Refs: Lin T-S, et al, J. Med. Chem. 1985, 28, p1194; Mo Y, et al, PNAS 1992, 89, p11021; Takeuchi et al., Carcinogenesis 1993, 292, p85

**8-Oxo-7-thioguanosine**[122970-43-8] C<sub>10</sub>H<sub>12</sub>N<sub>4</sub>O<sub>6</sub>S 316.29

NO02817

5mg	\$135.00
10mg	\$245.00
25mg	\$525.00

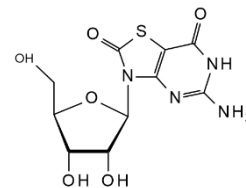
**PAc-rA**see *NG-(4-Methoxybenzoyl)adenosine*, NP57529 on page 329**Palmitoyl coenzyme A potassium salt**[1763-10-6] C<sub>37</sub>H<sub>65</sub>N<sub>7</sub>O<sub>17</sub>P<sub>3</sub>SK 1044.03

NP46059

1mg	\$60.00
2mg	\$90.00
5mg	\$187.50

**PAPS**see *3'-Phosphoadenosine-5'-phosphosulfate lithium salt hydrate*, NP46144 on page 340**PAP**see *Adenosine 3',5'-diphosphate disodium salt*, NA15774 on page 23

**pCPT-cAMP**

see 8-(4-Chlorophenylthio)adenosine 3',5'-cyclic monophosphate, NC10429 on page 151

**8-pCPT-cGMP**

see 8-(4-Chlorophenylthio)guanosine 3',5'-cyclic monophosphate sodium salt, NC10430 on page 151

**2'-O-Pentylamino-5'-O-DMT-adenosine**

see 5'-O-DMT-2'-O-pentylaminoadenosine, ND08568 on page 262

**5'-(2-Phenoxyacetate)-2'-deoxy-3'-O-[bis(4-methoxyphenyl)phenylmethyl]adenosine**

see 2'-Deoxy-3'-O-DMT-5'-O-phenoxyacetyladenosine, ND144749 on page 188

**N2-Phenoxyacetylguanosine**[119824-66-7] C<sub>18</sub>H<sub>19</sub>N<sub>5</sub>O<sub>7</sub> 417.37

NP45047

10g	\$66.00
25g	\$135.00
50g	\$210.00

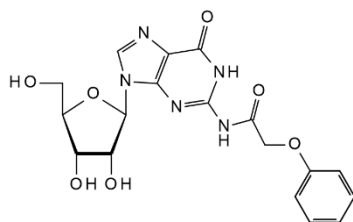
**N2-Phenoxyacetyl-2'-O-methylguanosine**C<sub>19</sub>H<sub>21</sub>N<sub>5</sub>O<sub>7</sub> 431.4

NP08428

Price On Application

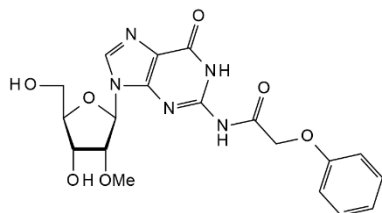
**N2-Phenoxyacetyl-3',5'-O-(1,1,3,3-tetraisopropyl-1,3-disiloxanediyl)guanosine**

• N2-Phenoxyacetyl-3',5'-TIPS-guanosine

[131474-72-1] C<sub>30</sub>H<sub>45</sub>N<sub>5</sub>O<sub>8</sub>Si<sub>2</sub> 659.88

NP45046

1g	\$450.00
2g	\$600.00
5g	\$850.00

**N2-Phenoxyacetyl-3',5'-TIPS-guanosine**

see N2-Phenoxyacetyl-3',5'-O-(1,1,3,3-tetraisopropyl-1,3-disiloxanediyl)guanosine, NP45046 on page 339

**N2-Phenylacetyl-L-guanosine**C<sub>18</sub>H<sub>19</sub>N<sub>5</sub>O<sub>6</sub> 401.37

NP09419

10g	\$3150.00
25g	\$5906.50
50g	\$7875.00

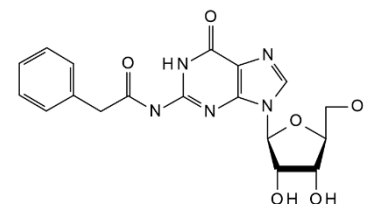
**N2-Phenylacetylguanosine**[132628-16-1] C<sub>18</sub>H<sub>19</sub>N<sub>5</sub>O<sub>6</sub> 401.37

NP06294

10g	\$89.30
25g	\$157.50
50g	\$262.50

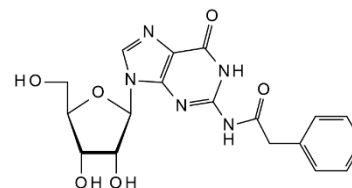

**Phenylamino****2-Phenylaminoadenosine**

• 2-Anilinoadenosine

[53296-10-9] C<sub>16</sub>H<sub>18</sub>N<sub>6</sub>O<sub>4</sub> 358.35

NP07291

5mg	\$80.00
10mg	\$105.00
25mg	\$168.00

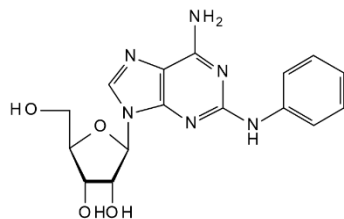

Refs: Martin et.al, Pharmacol. Biochem. Behav, 1993, 45, p951

**2',3'-Phenylboronate-5'-O-p-toluenesulfonyl-adenosine**C<sub>23</sub>H<sub>22</sub>BN<sub>5</sub>O<sub>6</sub>S 507.33

NP07357

50mg	\$89.50
100mg	\$168.00
250mg	\$262.50

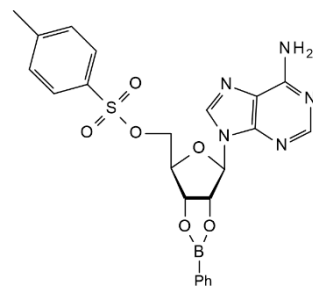
**6-O-(Phenylmethyl)guanosine**see *O6-Benzyl guanosine*, NB16621 on page 117**3-(Phenylmethyl)-1-β-D-ribofuranosyl-1H-pyrazolo[3,4-d]pyrimidin-4-amine**see *4-Amino-3-benzyl-1H-pyrazolo[3,4-d]pyrimidine 1-β-D-ribofuranose*, NA16507 on page 38**N-Phenylpyridin-4-amine**

• 4-Anilino-pyridine

[22961-45-1] C<sub>11</sub>H<sub>10</sub>N<sub>2</sub> 170.21

NP66702

1g	\$70.00
2g	\$100.00
5g	\$175.00

**Phenyl 3-pyridyl ketone**see *3-Benzoylpyridine*, NB70237 on page 112**4-Phenyl-2-pyrimidinamine**see *2-Amino-4-phenylpyrimidine*, NA57402 on page 60**4-Phenylpyrimidine-2-thiol**[60414-59-7] C<sub>10</sub>H<sub>8</sub>N<sub>2</sub>S 188.25

NP57408

500mg	\$60.00
1g	\$130.30
2g	\$241.70

**4-phenyl-6-(trifluoromethyl)-2-Pyrimidinamine**see *2-Amino-4-phenyl-6-(trifluoromethyl)pyrimidine*, NA57415 on page 60**3'-Phosphoadenosine 5'-phosphate**see *Adenosine 3',5'-diphosphate disodium salt*, NA15774 on page 23**3'-Phosphoadenosine-5'-phosphosulfate lithium salt hydrate**

- PAPS
- Adenosine 3'-phosphate 5'-phosphosulfate lithium salt hydrate

[109434-21-1] C<sub>10</sub>H<sub>15</sub>N<sub>5</sub>O<sub>13</sub>P<sub>2</sub>S·xLi·yH<sub>2</sub>O 507.27 (anhydrous free acid basis)

NP46144

1mg	\$330.00
2mg	\$500.00
5mg	\$760.00





**2'-Phosphoadenosine 5'-phosphosulfate tetralithium salt (mixture with 3'-isomer)**

• Adenosine 2(3')-phosphate 5'-phosphosulfate lithium salt

[102029-54-9][62230-89-1] C<sub>10</sub>H<sub>11</sub>N<sub>5</sub>O<sub>13</sub>P<sub>2</sub>S·4Li 531

NP46146

1mg	\$250.00
2mg	\$390.00
5mg	\$875.00

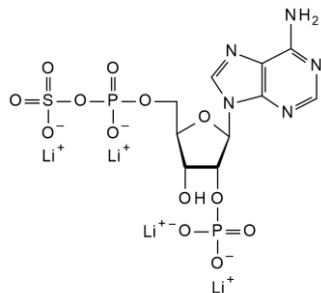
**3'-Phosphoadenosine 5'-phosphosulfate triethylammonium salt**[936827-87-1] C<sub>10</sub>H<sub>15</sub>N<sub>5</sub>O<sub>13</sub>P<sub>2</sub>S·4C<sub>6</sub>H<sub>15</sub>N 912.03

NP46906

1mg	\$175.00
2mg	\$300.00
5mg	\$625.00

**5'-Phosphoguanylyl-(3'->5')-guanosine**[33008-99-0] C<sub>20</sub>H<sub>26</sub>N<sub>10</sub>O<sub>15</sub>P<sub>2</sub>·xNa 708.43 (free acid basis)

NP46568

250ug \$625.00

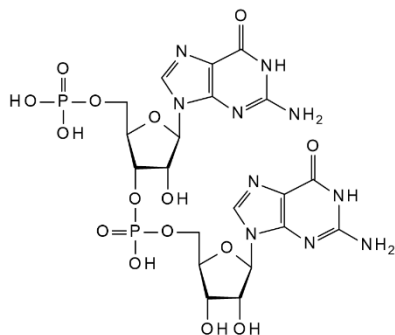
**1-(5-O-Phosphono-b-D-arabinofuranosyl)-2,4(1H,3H)-pyrimidinedione**

see 1-b-D-Arabinofuranosyluracil 5'-monophosphate, NA16509 on page 75

**(R)-9-[2-(Phosphonomethoxy)propyl]adenine**[147127-20-6] C<sub>9</sub>H<sub>14</sub>N<sub>5</sub>O<sub>4</sub>P 287.21

NP11733

1g	\$50.00
2g	\$80.00
5g	\$120.00

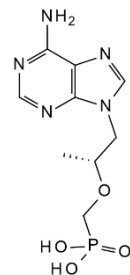
**5'-Phosphoribosylglycinamide**

see Glycinamide ribonucleotide, NG59700 on page 282

**N1-(5-Phospho-D-ribosyl)glycinamide**

see Glycinamide ribonucleotide, NG59700 on page 282

**5'-Phosphoryl-(3'-amino-3'-deoxyguanylyl)-(3'-5')-3'-amino-3'-deoxycytidine**

• [(2R,3S,4R,5R)-4-Amino-2-[[[(2R,3S,4R,5R)-4-amino-5-(4-amino-2-oxo-pyridin-1-yl)-3-phosphonoxy-oxolan-2-yl]methoxymethyl]-5-(2-amino-6-oxo-3H-purin-9-yl)oxolan-3-yl]oxyphosphonic acid

[109679-54-1] C<sub>19</sub>H<sub>28</sub>N<sub>10</sub>O<sub>13</sub>P<sub>2</sub> 666.43

NP28800

Price On Application

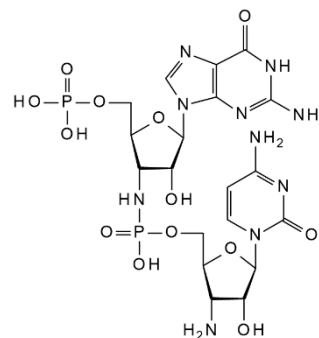

## PiC

## piC

see *Pseudoisocytidine hydrochloride*, NP63439 on page 345

## pidC

see *2'-Deoxypseudoisocytidine*, ND63440 on page 219

## 2-(Piperidin-4-Yloxy)Pyrimidine Dihydrochloride

[950649-19-1] C<sub>9</sub>H<sub>13</sub>N<sub>3</sub>O<sub>2</sub>·2HCl 252.14

NP57382	250mg	\$65.00
	500mg	\$105.00
	1g	\$227.80



## 2-(1-Piperidiny)-5-pyrimidinecarbaldehyde

[149806-11-1] 191.23

NP57429	500mg	\$85.00
	1g	\$195.50
	2g	\$312.70



## 5'-O-Pixylthymidine

C<sub>29</sub>H<sub>26</sub>N<sub>2</sub>O<sub>6</sub> 498.53

NP08579

Price On Application

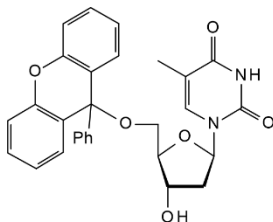

## Poly(G) potassium salt

see *Polyguanylic acid potassium salt*, NP44590 on page 342

## Polyguanylic acid potassium salt

• Poly(G) potassium salt

[54684-83-2]

NP44590	5mg	\$110.00
	10mg	\$210.00
	25mg	\$465.00



## Polyoxin B

[19396-06-6] C<sub>17</sub>H<sub>25</sub>N<sub>5</sub>O<sub>13</sub> 507.41

NP140526	500mg	\$50.00
	1g	\$90.00
	2g	\$157.00



## Polyoxin D

see *Polyoxorim*, NP157259 on page 342

## Polyoxorim

- 5-[[[2-Amino-5-O-(aminocarbonyl)-2-deoxy-L-xylonoyl]amino]-1-(5-carboxy-3,4-dihydro-2,4-dioxo-1(2H)-pyrimidinyl)-1,5-dideoxy-β-D-allofuranuronic acid
- Polyoxin D

[22976-86-9] C<sub>17</sub>H<sub>23</sub>N<sub>5</sub>O<sub>14</sub> 521.39

NP157259

Price On Application



## ppGpp

see *Guanosine 3',5'-bisdiphosphate lithium salt - 100mM aqueous solution*, NG58214 on page 282

**3'-O-[(Propan-2-ylidene)amino]-thymidine 5'-triphosphate**

• 3'-O-[(1-Methylethylidene)amino]-thymidine 5'-(tetrahydrogen triphosphate)

[1220515-68-3] C<sub>13</sub>H<sub>22</sub>N<sub>3</sub>O<sub>14</sub>P<sub>3</sub> 537.25

NP145591

2.5ug \$787.50

**N6-Propargyladenosine-5'-triphosphate sodium salt**C<sub>13</sub>H<sub>16</sub>N<sub>5</sub>O<sub>13</sub>P<sub>3</sub> 545.23

NP30541

1mg \$204.80  
2mg \$367.50  
5mg \$787.50**2'-O-Propargyladenosine**C<sub>13</sub>H<sub>15</sub>N<sub>5</sub>O<sub>4</sub> 305.29

NP00748

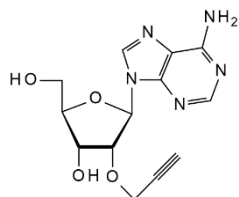
2mg \$45.00  
5mg \$90.00  
10mg \$140.00**3'-O-Propargyladenosine**C<sub>13</sub>H<sub>15</sub>N<sub>5</sub>O<sub>4</sub> 305.29

NP05471

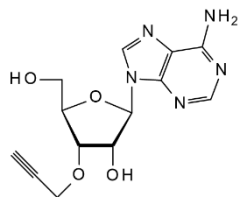
5mg \$42.00  
10mg \$63.00  
25mg \$131.50**N6-Propargyladenosine**C<sub>13</sub>H<sub>15</sub>N<sub>5</sub>O<sub>4</sub> 305.29

NP30546

1mg \$135.00  
2mg \$250.00  
5mg \$550.00**2'-O-Propargylcytidine**C<sub>12</sub>H<sub>15</sub>N<sub>3</sub>O<sub>5</sub> 281.26

NP06202

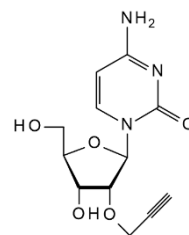
5mg \$47.30  
10mg \$78.80  
25mg \$171.00**3'-O-Propargylcytidine**C<sub>12</sub>H<sub>15</sub>N<sub>3</sub>O<sub>5</sub> 281.26

NP06049

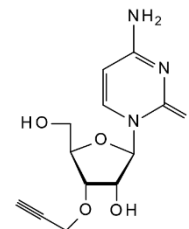
5mg \$47.30  
10mg \$63.00  
50mg \$262.50

**Propargylgua****2'-O-Propargylguanosine**C<sub>13</sub>H<sub>15</sub>N<sub>5</sub>O<sub>5</sub> 321.29

NP06253

5mg	\$68.30
10mg	\$115.50
25mg	\$236.50

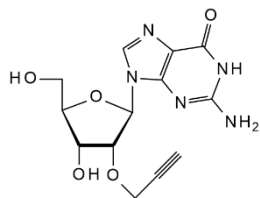
**3'-O-Propargyluridine**C<sub>12</sub>H<sub>14</sub>N<sub>2</sub>O<sub>6</sub> 282.25

NP06233

2mg	\$40.00
5mg	\$80.00
10mg	\$125.00

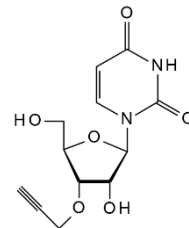
**3'-O-Propargylguanosine**C<sub>13</sub>H<sub>15</sub>N<sub>5</sub>O<sub>5</sub> 321.29

NP06219

5mg	\$80.00
10mg	\$130.00
25mg	\$275.00

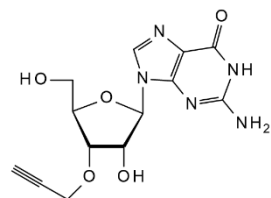
**8-(2-Propenyloxy)guanosine**

see 8-(Allyloxy)guanosine, NA16502 on page 32

**Propionyl coenzyme A lithium salt**[108321-21-7] C<sub>24</sub>H<sub>39</sub>N<sub>7</sub>O<sub>17</sub>P<sub>3</sub>SLi 829.53

NP47204

2mg	\$50.00
5mg	\$95.00
10mg	\$170.00

**2'-O-Propargyluridine**[129778-58-1] C<sub>12</sub>H<sub>14</sub>N<sub>2</sub>O<sub>6</sub> 282.25

NP06246

10mg	\$65.00
25mg	\$130.00
50mg	\$235.00

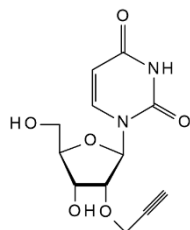
**N6-Propionylcordycepin**

see 3'-Deoxy-N6-propionyladenosine, ND10015 on page 219

**6-Propylamino-7-deazapurine**C<sub>9</sub>H<sub>12</sub>N<sub>4</sub> 176.22

NP11710

100mg	\$105.00
250mg	\$210.00
500mg	\$315.00

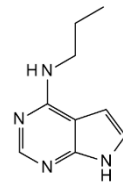

**2-(Propylthio)pyrimidine-5-carbaldehyde**

[876890-33-4] 182.24

NP57432

2g	\$89.20
5g	\$195.50
10g	\$312.70

**Pseudoisocytidine hydrochloride**

• piC

[57100-20-6] C<sub>9</sub>H<sub>13</sub>N<sub>3</sub>O<sub>5</sub>·HCl 279.68

NP63439

5mg	\$75.00
10mg	\$120.00
25mg	\$225.00

**Pseudoisocytidine**[57100-18-2] C<sub>9</sub>H<sub>13</sub>N<sub>3</sub>O<sub>5</sub> 243.22

NP63334

50mg	\$250.00
100mg	\$395.00
250mg	\$750.00

**Pseudothymidine**[65358-15-8] C<sub>10</sub>H<sub>14</sub>N<sub>2</sub>O<sub>5</sub> 242.23

NP16241

5mg	\$105.00
10mg	\$189.00
25mg	\$394.00

**Pseudouridine-5'-triphosphate - 100mM aqueous solution**[1175-34-4] C<sub>9</sub>H<sub>12</sub>N<sub>2</sub>O<sub>15</sub>P<sub>3</sub>Na<sub>3</sub> 550.09

NP09389

1mg	\$204.80
2mg	\$367.50
5mg	\$735.00

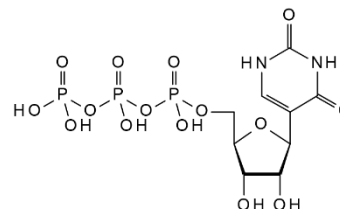
**Pseudouridine**[1445-07-4] C<sub>9</sub>H<sub>12</sub>N<sub>2</sub>O<sub>6</sub> 244.2

NP11297

25mg	\$65.00
50mg	\$100.00
100mg	\$175.00

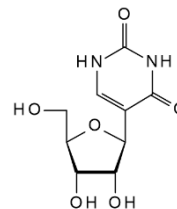
**PSI-6206**

see 2'-Deoxy-2'-fluoro-2'-C-methyluridine, ND29433 on page 200

**Purine riboside-5'-triphosphate**

• Nebularin 5'-triphosphate

[23197-96-8] C<sub>10</sub>H<sub>15</sub>N<sub>4</sub>O<sub>13</sub>P<sub>3</sub> 492.17

NP58309

Price On Application



**Puromycindih****Puromycin dihydrochloride**

• 3-[ $\alpha$ -Amino-p-methoxyhydrocinnamamido]-3'-deoxy-N,N-dimethyladenosine dihydrochloride

[58-58-2] C<sub>22</sub>H<sub>29</sub>N<sub>7</sub>O<sub>5</sub>·2HCl 544.44

NP09203	100mg	\$100.00
	250mg	\$210.00
	500mg	\$350.00

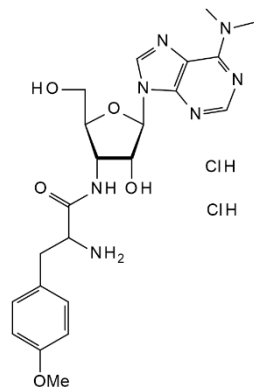
**Pyrazolo[1,5-a]pyrimidine-2-carboxylic acid**

[378211-85-9] C<sub>7</sub>H<sub>5</sub>N<sub>3</sub>O<sub>2</sub> 163.13

NP57366	250mg	\$87.50
	500mg	\$140.00
	1g	\$334.70

**4-(3-Pyridinyl)-2-aminopyrimidine**

see 4-(3-Pyridinyl)-2-pyrimidine amine, NP57381 on page 346

**4-(Pyridin-3-yl)pyrimidin-2-amine**

see 4-(3-Pyridinyl)-2-pyrimidine amine, NP57381 on page 346

**4-(3-Pyridinyl)-2-pyrimidine amine**

• 4-(3-Pyridinyl)-2-aminopyrimidine  
• 4-(Pyridin-3-yl)pyrimidin-2-amine

[66521-66-2] 172.19

NP57381	500mg	\$90.00
	1g	\$223.30
	2g	\$357.30

**2-Pyridin-2-ylpyrimidine-5-carbaldehyde**

[954226-94-9] C<sub>10</sub>H<sub>7</sub>N<sub>3</sub>O 185.18

NP57439	1g	\$81.40
	2g	\$130.10
	5g	\$323.00

**Pyrido[3,4-d]pyrimidine-2,4(1H,3H)-dione**

[21038-67-5]

NP44307

Price On Application

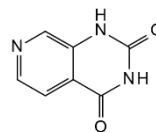
**6-(2-Pyridylmethylthio)-9-b-D-ribofuranosyl-9H-purine**

see 6-(2-Pyridylmethylthio)-9-(b-D-ribofuranosyl)purine, NP07299 on page 347

**6-(2-Pyridylmethylthio)-9-(b-D-ribofuranosyl)purine**

• 6-(2-Pyridylmethylthio)-9-b-D-ribofuranosyl-9H-purine

C<sub>16</sub>H<sub>17</sub>N<sub>5</sub>O<sub>4</sub>S 375.4

NP07299

50mg	\$89.50
100mg	\$168.00
250mg	\$262.50

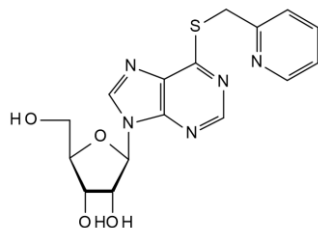
**Pyrimidine-5-carbothioic acid amide**[88891-75-2] C<sub>5</sub>H<sub>5</sub>N<sub>2</sub>S 139.18

NP57371

25mg	\$65.50
50mg	\$116.50
100mg	\$186.00

**4-Pyrimidinecarboxaldehyde, dimethyl acetal**

see 4-(Dimethoxymethyl)pyrimidine, ND57369 on page 249

**Pyrimidine-5-carboxamide hydrochloride**

• Pyrimidin-5-yl-methanediamine hydrochloride

[690619-43-3] C<sub>5</sub>H<sub>6</sub>N<sub>4</sub>·HCl 158.59

NP57377

100mg	\$86.00
250mg	\$105.00
500mg	\$170.00

**4-Pyrimidinecarboxylic acid hydrazide**

see Pyrimidine-4-carboxylic acid hydrazide, NP57376 on page 347

**Pyrimidine-4-carboxylic acid hydrazide**

• 4-Pyrimidinecarboxylic acid hydrazide

[39513-54-7] C<sub>5</sub>H<sub>6</sub>N<sub>4</sub>O 138.13

NP57376

250mg	\$70.00
500mg	\$110.00
1g	\$318.50

**Pyrimidine-4-carboxylic acid methyl ester**

• Methyl 4-pyrimidine carboxylate

[2450-08-0] C<sub>6</sub>H<sub>6</sub>N<sub>2</sub>O<sub>2</sub> 138.12

NP57387

500mg	\$50.00
1g	\$75.00
2g	\$100.00

**2-Pyrimidinemethanamine**

• Pyrimidin-2-yl-methylamine

[75985-45-4] C<sub>5</sub>H<sub>7</sub>N<sub>3</sub> 109.13

NP57370

50mg	\$60.50
100mg	\$97.00
250mg	\$122.50

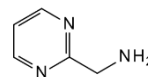
**Pyrimidine-2-ylhydrazine**

• 2-Hydrazinopyrimidine

[7504-94-1] C<sub>4</sub>H<sub>6</sub>N<sub>4</sub> 110.12

NP57400

500mg	\$60.00
1g	\$90.00
2g	\$170.00

**Pyrimidin-2-ylmethanamine oxalate**

see 2-(Aminomethyl)pyrimidine oxalate, NA57383 on page 59

## PyrimidinyIm

## Pyrimidin-5-yl-methanedianine hydrochloride

see *Pyrimidine-5-carboxamide hydrochloride, NP57377* on page 347

## Pyrimidin-2-yl-methylamine

see *2-Pyrimidinemethanamine, NP57370* on page 347

## 6-Pyrrolidino-7-deazapurine

C<sub>10</sub>H<sub>12</sub>N<sub>4</sub> 188.23

NP11711

100mg	\$116.00
250mg	\$210.00
500mg	\$395.00

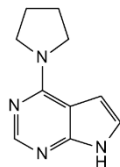

## P

## 2-Pyrrolidin-1-ylpyrimidine-5-carbaldehyde

[937796-10-6] 177.2

NP57437

1g	\$95.30
----	---------



## N-Pyrrolo-2'-deoxycytidine

• 6-Methyl-3-(β-D-2-deoxyribofuranosyl)pyrrolo[2,3-d]pyrimidin-2-one

[382137-74-8] C<sub>12</sub>H<sub>15</sub>N<sub>3</sub>O<sub>4</sub> 265.27

NP08698

2mg	\$64.00
5mg	\$125.00
10mg	\$200.00

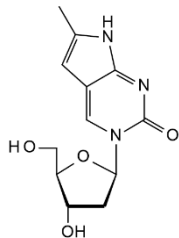

## 7H-Pyrrolo[2,3d]pyrimidine

[271-70-5] C<sub>6</sub>H<sub>5</sub>N<sub>3</sub> 119.12

NP32608

1g	\$50.00
2g	\$80.00
5g	\$150.00



## Queuosine

see *7-(4,5-cis-Dihydroxy-1-cyclopenten-3-ylaminomethyl)-7-deazaguanosine, ND157876* on page 248

## Racivir

see *(+)-Emtricitabine, NE16704* on page 267

## Regadenoson

• 2-[4-[(Methylamino)carbonyl]-1H-pyrazol-1-yl]-adenosine

[313348-27-5] C<sub>15</sub>H<sub>18</sub>N<sub>8</sub>O<sub>5</sub> 390.36

NR07283

2mg	\$68.00
5mg	\$120.00
10mg	\$160.00

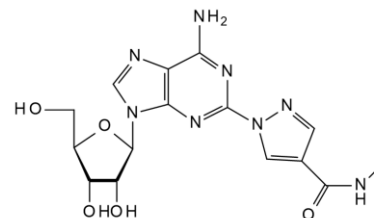

Refs: Palle VP, et.al, J.A Drug Dev.Res, 2000, 50, p64



## Ribavirin 5'-diphosphate lithium salt

[63142-70-1] C<sub>8</sub>H<sub>12</sub>N<sub>4</sub>O<sub>11</sub>P<sub>2</sub>Li<sub>2</sub> 416.03

NR10471

1mg	\$464.40
2mg	\$774.00
5mg	\$1612.50

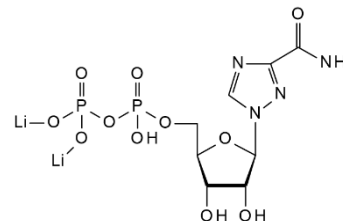



**a-Ribavirin (impurity B)**[57198-02-4] C<sub>8</sub>H<sub>12</sub>N<sub>4</sub>O<sub>5</sub> 244.2

NR10396

1mg	\$235.00
2mg	\$420.00
5mg	\$875.00

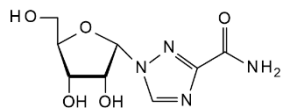
**Ribavirin Impurity G**see *Isoribavirin*, NI09827 on page 300**Ribavirin 5'-monophosphate diammonium salt**

• Virazole 5'-monophosphate

C<sub>8</sub>H<sub>19</sub>N<sub>6</sub>O<sub>8</sub>P 358.25

NR46023

Price On Application

**Ribavirin 5'-monophosphate dilithium salt**[66983-94-6] C<sub>8</sub>H<sub>11</sub>Li<sub>2</sub>N<sub>4</sub>O<sub>8</sub>P 336.05

NR04851

1mg	\$89.30
2mg	\$157.50
5mg	\$300.00

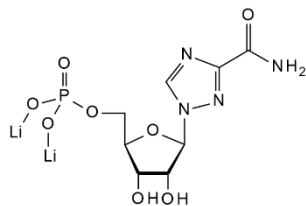
**Ribavirin 5'-monophosphate sodium salt**[40925-28-8] C<sub>8</sub>H<sub>13</sub>N<sub>4</sub>O<sub>8</sub>P·xNa 324.18 (free acid basis)

NR46024

2mg \$1100.00

**Ribavirin 5'-triphosphate sodium salt**

• 1-b-D-Ribofuranosyl-1,2,4-triazole-3-carboxamide-5'-triphosphate

[63142-71-2] C<sub>8</sub>H<sub>12</sub>N<sub>4</sub>Na<sub>4</sub>O<sub>14</sub>P<sub>3</sub> 550.09

NR09650

1mg	\$390.00
2mg	\$750.00
5mg	\$1750.00

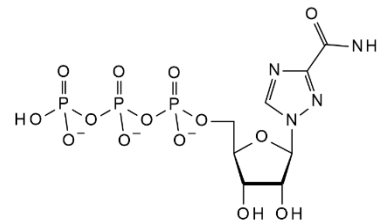
**Ribavirin 5'-triphosphate tetrasodium salt - 10mM aqueous solution**

• 1-b-D-Ribofuranosyl-1,2,4-triazole-3-carboxamide-5'-triphosphate

[63142-71-2] C<sub>8</sub>H<sub>15</sub>N<sub>4</sub>O<sub>14</sub>P<sub>3</sub>·Na<sub>4</sub> 576.1

NR63594

1mg	\$390.00
2mg	\$750.00
5mg	\$1750.00

**Ribavirin 5'-triphosphate triethylammonium salt - 10 mM aqueous solution**

• 1-b-D-Ribofuranosyl-1,2,4-triazole-3-carboxamide-5'-triphosphate

C<sub>8</sub>H<sub>14</sub>N<sub>4</sub>O<sub>14</sub>P<sub>3</sub>·Na 506.13

NR12804

1mg	\$395.00
2mg	\$700.00
5mg	\$1250.00

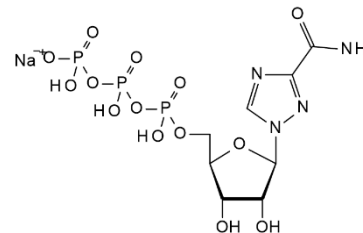

**Ribavirin****Ribavirin**

- 1-b-D-Ribofuranosyl-1H-1,2,4-triazole-3-carboxamide
- Viramid

[36791-04-5] C<sub>8</sub>H<sub>12</sub>N<sub>4</sub>O<sub>5</sub> 244.2

NR02712	50g	\$60.00
	100g	\$100.00
	250g	\$200.00

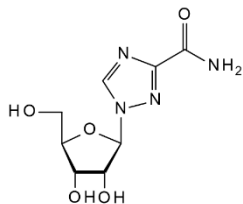

Refs: Crotty S, Maag D, Arnold JJ, Zhong W, Lau JYN, et al, Nature Medicine 2000, 6, 1375-1379

**Ribocytidine 3'(2')-Monophosphate**see *Cytidine 3'(2')-monophosphate*, NC03937 on page 161**Riboflavin 5'-adenosine diphosphate disodium salt hydrate**

- FAD-Na<sub>2</sub>
- Flavin adenosine dinucleotide disodium salt
- Adenosine-riboflavine dinucleotide

[84366-81-4][146-14-5] C<sub>27</sub>H<sub>31</sub>N<sub>9</sub>Na<sub>2</sub>O<sub>15</sub>P<sub>2</sub>·xH<sub>2</sub>O 829.51 (anhydrous basis)

NR35410	250mg	\$75.00
	500mg	\$120.00
	1g	\$200.00

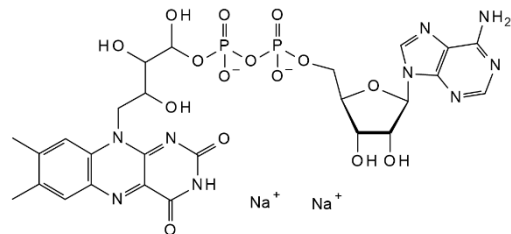
**Riboflavin 5'-(trihydrogen diphosphate) P'→5'-ester with N-(2-Aminoethyl)adenosine**

- N6-(2-Aminoethyl)-FAD

[167962-39-2] C<sub>28</sub>H<sub>38</sub>N<sub>10</sub>O<sub>15</sub>P<sub>2</sub> 828.62

NR76131

Price On Application

**9-(b-D-Ribofuranosyl)-6-furfurylaminopurine**see *Kinetin riboside*, NK06717 on page 301**9-(b-L-Ribofuranosyl)adenine**see *L-Adenosine*, NA06227 on page 27**N1-(b-D-Ribofuranosyl)-5-aminoimidazole-4-carboxamide**see *5-Aminoimidazole-4-carboxamide-1-b-D-ribofuranose*, NA03552 on page 56**1-(b-L-ribofuranosyl)cytosine**see *L-Cytidine*, NC02628 on page 162**1-(b-D-Ribofuranosyl)-5-fluorouracil**see *5-Fluorouridine*, NF04076 on page 280**N-(9-b-D-Ribofuranosyl-9H-furin-6-yl)-butyramide cyclic 3',5'-(hydrogen phosphate) 2'-butyrate**[362-74-3] C<sub>18</sub>H<sub>24</sub>N<sub>5</sub>O<sub>8</sub>P 469.39

NR145431

Price On Application

**9-(b-D-Ribofuranosyl)guanine**see *Guanosine*, NG06314 on page 286**9-(b-D-[2-18O]Ribofuranosyl)guanine**see *[2-18O]Guanosine*, NG106386 on page 286**9-(b-L-Ribofuranosyl)guanine**see *L-Guanosine*, NG05944 on page 286**1-(b-D-Ribofuranosyl)-5-hydroxyimidazole-4-carboxamide**see *Mizoribine*, NM09731 on page 329**1-b-D-Ribofuranosyl-4-hydroxy-2-pyridone**see *3-Deazaauridine*, ND16524 on page 170

**1-b-D-Ribofuranosyl-5-iodocytosine**see *5-Iodocytidine*, NI04748 on page 294**1-b-D-Ribofuranosylisobarbituric acid**see *5-Hydroxyuridine*, NH32540 on page 291**9-(b-D-Ribofuranosyl)isoguanine**

## • Isoguanosine

[1818-71-9] C<sub>10</sub>H<sub>13</sub>N<sub>5</sub>O<sub>5</sub> 283.25

NR09651	100mg	\$120.00
	250mg	\$275.00
	500mg	\$475.00

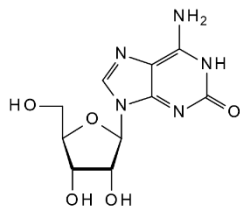
**1-(b-D-Ribofuranosyl)-5-nitropyridine-2-one**[59892-36-3] C<sub>10</sub>H<sub>12</sub>N<sub>2</sub>O<sub>7</sub> 272.21

NR04848	50mg	\$210.00
	100mg	\$368.00
	250mg	\$682.50

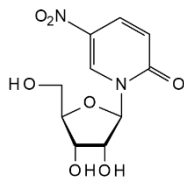
**9-b-D-Ribofuranosylpurine triacetate**see *2',3',5'-Tri-O-acetylnebularine*, NT16568 on page 372**9-(b-D-Ribofuranosyl)purine**

## • Nebularine

[550-33-4] C<sub>10</sub>H<sub>12</sub>N<sub>4</sub>O<sub>4</sub> 252.23

NR05251	50mg	\$85.00
	100mg	\$145.00
	250mg	\$325.00

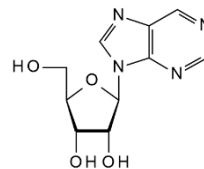

Refs: Iwamura H, Hashizume T, J.O.C, 1968, 33, 5, p1796

**N-(9-b-D-Ribofuranosyl-9H-purin-6-yl)-L-aspartic acid**see *N6-Succinyl adenosine*, NS16562 on page 354**N-(9-b-D-Ribofuranosyl-9H-purin-6-yl)-formamide**see *N6-Formyl-adenosine*, NF146409 on page 280**1-b-D-Ribofuranosyl-1H-pyrazolo[3,4-d]pyrimidine-4-one**see *Allopurinol riboside*, NA07960 on page 31**1-b-D-Ribofuranosyl-2(1H)-pyrimidinone**see *4-Deoxyuridine*, ND09503 on page 225**1-b-D-Ribofuranosyl-1,2,4-triazole-3-carboxamide-5'-triphosphate, lithium salt**

NR32047

Price On Application

**1-b-D-Ribofuranosyl-1,2,4-triazole-3-carboxamide-5'-triphosphate**see *Ribavirin 5'-triphosphate sodium salt*, NR09650 on page 349**1-b-D-Ribofuranosyl-1,2,4-triazole-3-carboxamide-5'-triphosphate**see *Ribavirin 5'-triphosphate tetrasodium salt - 10mM aqueous solution*, NR63594 on page 349

**Ribofuranosyl****1-b-D-Ribofuranosyl-1,2,4-triazole-3-carboxamide-5'-triphosphate**

see *Ribavirin 5'-triphosphate triethylammonium salt - 10 mM aqueous solution, NR12804 on page 349*

**1-b-D-Ribofuranosyl-1H-1,2,4-triazole-3-carboxamide**

see *Ribavirin, NR02712 on page 350*

**1-b-D-Ribofuranosyl-1H-1,2,4-triazole-5-carboxamide**

see *Isoribavirin, NI09827 on page 300*

**1-(a-D-Ribofuranosyl)uracil**

[3258-07-9] C<sub>9</sub>H<sub>12</sub>N<sub>2</sub>O<sub>6</sub> 244.2

NR31832

5g	\$1050.00
10g	\$1700.00
25g	\$3125.00



R

**1-(b-L-ribofuranosyl)uracil**

see *L-Uridine, NU04051 on page 382*

**4-(b-D-Ribofuranosyl)-vic-triazolo[4,5-b]pyridin-5-one**

• 1,4-Dihydro-4-(b-D-ribofuranosyl)-5H-1,2,3-triazolo[4,5-b]pyridin-5-one

[59892-40-9] C<sub>10</sub>H<sub>12</sub>N<sub>4</sub>O<sub>5</sub> 268.23

NR04971

25mg	\$236.50
50mg	\$394.00
100mg	\$683.00

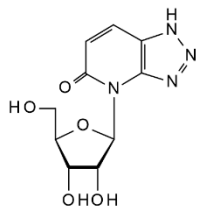
**9-b-D-Ribofuranosylxanthine**

see *Xanthosine, NX02884 on page 384*

**9-b-D-Ribofuranosylxanthine**

see *Xanthosine dihydrate, NX28984 on page 383*

**L-Ribose NAD**

663

NL30093

Price On Application

**Rp-Adenosine 3',5'-cyclic monophosphorothioate triethylammonium salt hydrate**

see *Adenosine 3',5'-cyclic monophosphorothioate Rp-isomer triethylammonium salt, NA08993 on page 22*

**Rp-8-Br-cAMPS**

see *8-Bromoadenosine 3',5'-cyclic monophosphorothioate, Rp-isomer sodium salt, NB13568 on page 122*

**Rp-Cyclic 3',5'-hydrogen phosphorothioate adenosine triethylammonium salt**

see *Adenosine 3',5'-cyclic monophosphorothioate Rp-isomer triethylammonium salt, NA08993 on page 22*

**SAICAR Dibarium salt**

see *N-Succinyl-5-aminoimidazole-4-carboxamide ribose 5'-phosphate dibarium salt, NS45131 on page 354*

**SAICAR**

see *N-Succinyl-5-aminoimidazole-4-carboxamide ribose disodium salt, NS16860 on page 354*

**SAM chloride dihydrochloride**

see *S-(5'-Adenosyl)-L-methionine chloride dihydrochloride, NA29499 on page 28*

**SAMe p-toluenesulfonate**

see *S-Adenosyl-L-methionine p-toluenesulfonate, NA04017 on page 28*

**Sangivamycin**

• 7-Deaza-7-carbamoyladenosine

[18417-89-5]  $C_{12}H_{15}N_5O_5 \cdot xH_2O$  309.28 (anhydrous basis)

NS139064

Price On Application

**Sanilvudine**

see 2',3'-Dideohydro-2',3'-dideoxythymidine, ND07118 on page 239

**Sapacitabine**

• 1-(2-Deoxy-2-cyano-b-D-arabinofuranosyl)cytosine

[151823-14-2]  $C_{26}H_{42}N_4O_5$  490.64

NS29828

Price On Application

**2-(sec-Butylthio)pyrimidine-5-carbaldehyde**[915920-24-0]  $C_9H_{12}N_2OS$  196.27

NB57434

1g	\$81.40
2g	\$130.10
5g	\$323.00

**Sonedenoson**

see 2-[2-(4-Chlorophenyl)ethoxy]adenosine, NC16521 on page 150

**Sp-8-Br-cAMP**

see 8-Bromoadenosine 3',5'-cyclic monophosphorothioate, Sp-isomer sodium salt, NB08953 on page 123

**Sp-cAMPS. TEA**

see Adenosine 3',5'-cyclic monophosphorothioate Sp-isomer triethylammonium salt, NA08995 on page 22

**Sp-cAMPS**

see Adenosine 3',5'-cyclic monophosphothioate Sp-isomer sodium salt, NA08994 on page 22

**Stavudine 5'-monophosphate sodium salt - 10 mM aqueous solution**

• 2',3'-Dideohydro-2',3'-dideoxythymidine-5'-monophosphate sodium salt

 $C_{10}H_{13}N_2O_7P \cdot xNa$  304.19 (free acid)

NS30745	50ug	\$199.50
	250ug	\$657.50
	500ug	\$1105.00

**Stavudine 5'-monophosphate triethylammonium salt**

• 2',3'-Dideohydro-2',3'-dideoxythymidine 5'-monophosphate sodium salt

NS15337	1mg	\$504.00
	2mg	\$882.00
	5mg	\$1890.00

**Stavudine 5'-triphosphate sodium salt - 10 mM aqueous solution**

• 2',3'-Dideohydro-2',3'-dideoxy-thymidine-5'-triphosphate sodium salt

 $C_{10}H_{15}N_2O_{13}P_3 \cdot xNa$  464.15 (free acid)

NS30746	100ug	\$305.00
	200ug	\$504.00

**Stavudine 5'-triphosphate triethylammonium salt**

• 2',3'-Dideohydro-2',3'-dideoxythymidine 5'-triphosphate sodium salt

NS15336	1mg	\$504.00
	2mg	\$882.00
	5mg	\$1890.00



**Stavudine****Stavudine**

see 2',3'-Didehydro-2',3'-dideoxythymidine, ND07118 on page 239

**Stearoyl coenzyme A**

• n-Octadecanoyl coenzyme A

[362-66-3] C<sub>39</sub>H<sub>70</sub>N<sub>7</sub>O<sub>17</sub>P<sub>3</sub>S 1034

NS47205	5mg	\$125.00
	10mg	\$195.00
	25mg	\$375.00

**N6-Succinyl adenosine**

- N-(9-b-D-Ribofuranosyl-9H-purin-6-yl)-L-aspartic acid
- 6-(1,2-Dicarboxylethylamino)-9-b-D-ribofuranosylpurine
- (S)-N-(1,2-Dicarboxylethyl)adenosine

[4542-23-8] C<sub>14</sub>H<sub>17</sub>N<sub>5</sub>O<sub>8</sub> 383.31

NS16562	1mg	\$90.00
	2mg	\$150.00
	5mg	\$250.00

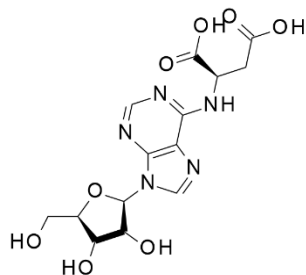

Refs: Wevers, R, et al, Clin. Chem, 41, 744 (1995); Nassogne, M, et al, Brain Dev, 22, 383 (2000); Jurecka, A, et al, Mol. Genet, 94, 435 (2008)

**N-Succinyl-5-aminoimidazole-4-carboxamide ribose disodium salt**

- N-[(5-Amino-1-b-D-ribofuranosyl-1H-imidazol-4-yl)carbonyl]-L-aspartic acid
- SAICAR

[17388-80-6] C<sub>13</sub>H<sub>16</sub>N<sub>4</sub>O<sub>9</sub>Na<sub>2</sub> 418.27

NS16860	1mg	\$180.00
	2mg	\$310.00
	5 mg	\$650.00

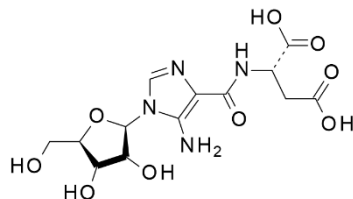

Refs: Gollub, E.G, et al, J. Bacteriol, 78, 320 (1959); Srivastava, P.C, et al, J. Med. Chem, 17, 1207 (1974)

**N-Succinyl-5-aminoimidazole-4-carboxamide ribose 5'-phosphate dibarium salt**

- SAICAR Dibarium salt
- N-[(5-Amino-1-b-D-ribofuranosylimidazol-4-yl)carbonyl]-L-aspartic acid

[6057-44-9][3031-95-6] C<sub>13</sub>H<sub>15</sub>Bar<sub>2</sub>N<sub>4</sub>O<sub>12</sub>P 724.91

NS45131	.5mg	\$250.00
	1mg	\$450.00
	2mg	\$800.00

**2'-TBDMS-Bz-rA**

see N6-Benzoyl-2'-O-tert-butylidimethylsilyadenosine, NT57542 on page 94

**2'-TBDMS-Bz-rC**

see N4-Benzoyl-2'-O-tert-butylidimethylsilycytidine, NT57545 on page 95

**3TC**

see Lamivudine, NL06295 on page 302

**TDP-Fucose**

see Thymidine-5'-diphosphate-b-L-fucose, NT04379 on page 363

**Telbivudine**

see L-Thymidine, NT02679 on page 365

**Tert-Butyl 2-Phenyl-4-(P-Tolylsulfonyloxy)-7,8-Dihydropyrido[4,3-D]Pyrimidine-6(5H)-Carboxylate**C<sub>25</sub>H<sub>27</sub>N<sub>3</sub>O<sub>5</sub>S 481.57

NB57393	25mg	\$93.00
	50mg	\$186.00
	100mg	\$298.00



**2,4,5,6-Tetraaminopyrimidine 2HCl**

[39944-62-2]

NT44267

Price On Application

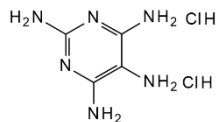
**Tetrabenzyl-D-thymidine-3',5'-diphosphate**see *Thymidine-3',5'-tetrabenzylidiphosphate*, NT07361 on page 364**n-Tetradecanoyl coenzyme A lithium salt**see *Myristoyl coenzyme A lithium salt*, NM63223 on page 329**n-Tetradecanoyl coenzyme A**see *Myristoyl coenzyme A*, NM47200 on page 330**3',5'-O-(1,1,3,3-Tetraisopropyl-1,3-disiloxanediyl)adenosine**

• 3',5'-TIPPS-D-adenosine

[69304-45-6] C<sub>22</sub>H<sub>39</sub>N<sub>5</sub>O<sub>5</sub>Si<sub>2</sub> 509.76

NT08580

500mg	\$60.00
1g	\$99.80
2g	\$147.00

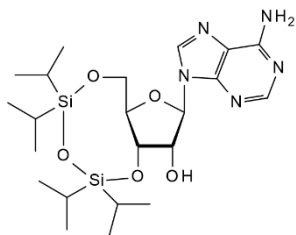
**3',5'-O-(1,1,3,3-Tetraisopropyl-1,3-disiloxanediyl)cytidine**

• 3',5'-TIPS-cytidine

[69304-42-3] C<sub>21</sub>H<sub>39</sub>N<sub>3</sub>O<sub>6</sub>Si<sub>2</sub> 485.72

NT08581

1g	\$73.50
2g	\$115.50
5g	\$262.50

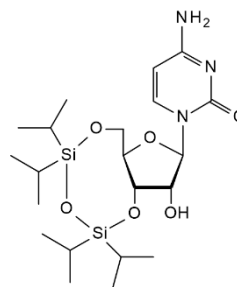
**3',5'-O-(1,1,3,3-Tetraisopropyl-1,3-disiloxanediyl)guanosine**

• 3',5'-O-TIPPS-guanosine

[69304-44-5] C<sub>22</sub>H<sub>39</sub>N<sub>5</sub>O<sub>6</sub>Si<sub>2</sub> 525.76

NT08583

1g	\$95.00
2g	\$140.00
5g	\$300.00

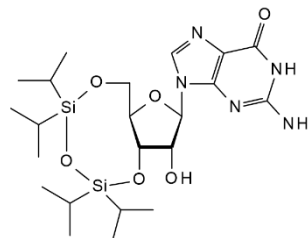
**3',5'-O-(1,1,3,3-Tetraisopropyl-1,3-disiloxane-1,3-diyl)-2'-ketouridine**

• 3',5'-O-(Tetraisopropyl-1,3-disiloxane-1,3-diyl)-2'-oxouridine

[84828-97-7] C<sub>21</sub>H<sub>36</sub>N<sub>2</sub>O<sub>7</sub>Si<sub>2</sub> 484.69

NT31833

100mg	\$72.00
250mg	\$142.50
500mg	\$225.00

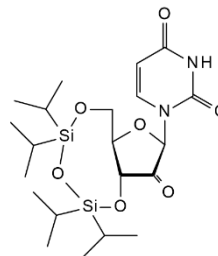

**Tetraisoprop****3',5'-O-(1,1,3,3-Tetraisopropyl-1,3-disiloxanediyl)-5-methyluridine**[130983-87-8] C<sub>22</sub>H<sub>40</sub>N<sub>2</sub>O<sub>7</sub>Si<sub>2</sub> 500.73

Price On Application

NT57556

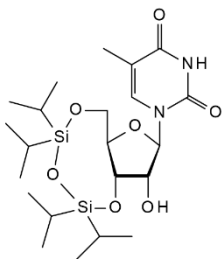
**3',5'-O-(1,1,3,3-Tetraisopropyl-1,3-disiloxanediyl)-2'-(p-nitrophenylcarbonyloxy)uridine**[202533-73-1] C<sub>28</sub>H<sub>41</sub>N<sub>3</sub>O<sub>11</sub>Si<sub>2</sub> 651.81

1g \$1500.00

NT61635

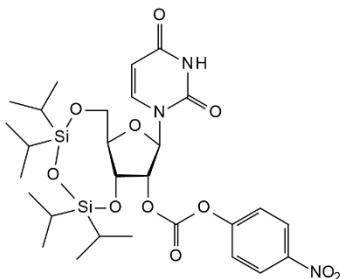
**3',5'-O-(Tetraisopropylidisiloxane-1,3-diyl)-2'-oxouridine**

see 3',5'-O-(1,1,3,3-Tetraisopropylidisiloxane-1,3-diyl)-2'-ketouridine, NT31833 on page 355

**3',5'-O-(1,1,3,3-Tetraisopropyl-1,3-disiloxanediyl)uridine**

• 3',5'-TIPPS-uridine

[69304-38-7] C<sub>21</sub>H<sub>38</sub>N<sub>2</sub>O<sub>7</sub>Si<sub>2</sub> 486.71

NT08582

1g	\$65.00
2g	\$112.00
5g	\$225.00

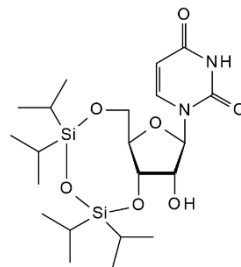
**3',5'-O-Tetraisopropylidisiloxane guanosine**

see 3',5'-O-[Tetrakis(1-methylethyl)-1,3-disiloxanediyl]-guanosine, NT16564 on page 356

**3',5'-O-[1,1,3,3-tetrakis(1-methylethyl)-1,3-disiloxanediyl]-guanosine**

see 3',5'-O-[Tetrakis(1-methylethyl)-1,3-disiloxanediyl]-guanosine, NT16564 on page 356

**3',5'-O-[Tetrakis(1-methylethyl)-1,3-disiloxanediyl]-guanosine**

- 3',5'-O-[1,1,3,3-tetrakis(1-methylethyl)-1,3-disiloxanediyl]-guanosine
- 6H-Furo[3,2-f]-1,3,5,2,4-trioxadisilocin, guanosine deriv.
- 3',5'-O-Tetraisopropylidisiloxane guanosine

[88183-82-8] C<sub>22</sub>H<sub>39</sub>N<sub>5</sub>O<sub>6</sub>Si<sub>2</sub> 525.75

NT16564

2mg	\$142.76
5mg	\$259.55
10mg	\$471.90

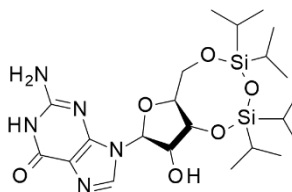



**5-[4-(4,4,5,5-tetramethyl-[1,3,2]dioxaborolan-2-yl)-benzylidene]-pyrimidine-2,4,6-trione**

NT44284

1g	\$93.50
2g	\$149.60
5g	\$239.30

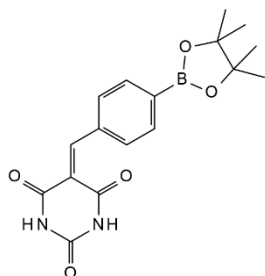
**Tezacitabine**

see (E)-2'-Deoxy-2'-(fluoromethylene)cytidine, ND10202 on page 200

**TFA-aa-dC**

[96102-27-1] 378.3

NT57548

Price On Application

**TFA-aa-dU**

[115794-55-3] 379.29

NT57550

Price On Application

**TFA-aha-dC**

491.46

NT57549

Price On Application

**TFA-aha-dU**

[252337-58-9] 396.45

NT57552

Price On Application

**TFA-ap-dU**

377.27

NT57551

Price On Application

**2'-TFA-NH-dA**

362.26

NT57539

Price On Application



## TFANHdC

## 2'-TFA-NH-dC

338.24

NT57540

Price On Application



## 2'-TFA-NH-dG

378.26

NT57541

Price On Application



## 2-(2-Thienyl)-5-pyrimidinecarbaldehyde

[921939-12-0] C<sub>9</sub>H<sub>6</sub>N<sub>2</sub>O<sub>S</sub> 190.22

NT57436

1g	\$81.40
2g	\$130.10
5g	\$323.00



## 4-(2-Thienyl)-2-pyrimidinethiol

• 4-(Thiophen-2-yl)pyrimidine-2-thiol

[175202-75-2] C<sub>8</sub>H<sub>6</sub>N<sub>2</sub>S<sub>2</sub> 194.28

NT57413

500mg	\$60.00
1g	\$134.80
2g	\$215.70



## 2-Thioadenosine

[43157-50-2] C<sub>10</sub>H<sub>13</sub>N<sub>5</sub>O<sub>4</sub>S 299.31

NT07655

25mg	\$121.00
50mg	\$205.00
100mg	\$368.00

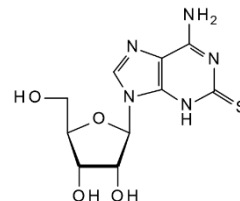

## 6-Thio-9-(b-D-arabinofuranosyl)purine

• 6-Mercapto-9-(b-D-arabinofuranosyl)purine

[90899-89-1][892-49-9] C<sub>10</sub>H<sub>12</sub>N<sub>4</sub>O<sub>4</sub>S 284.29

NM06321

100mg	\$69.00
200mg	\$96.00
500mg	\$160.00

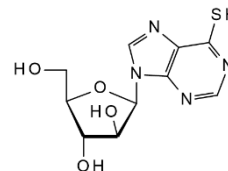

## a-Thio-ATP

see Adenosine-5'-O-(1-thiotriphosphate) lithium salt - 100 mM aqueous solution, NA58205 on page 26

## 2-Thio-6-azauridine

see 6-Aza-2-thiouridine, NA08057 on page 78

## a-Thio-CTP

see Cytidine-5'-O-(1-thiotriphosphate) lithium salt - 100mM aqueous solution, NC58206 on page 161

**2-Thiocytidine**[13239-97-9] C<sub>9</sub>H<sub>13</sub>N<sub>3</sub>O<sub>4</sub>S 259.28

NT02911

5mg	\$60.00
10mg	\$95.00
25mg	\$175.00

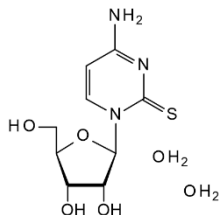

Refs: Ueda T, Ohsuka H, Chem. Pharm. Bull. 1973, 21, 7, p1530

**α-Thio-dATP**

see 2'-Deoxyadenosine-5'-O-(1-thiotriphosphate) lithium salt - 100 mM aqueous solution, ND32070 on page 172

**4'-Thio-2'-deoxythymidine**[134111-35-6] C<sub>10</sub>H<sub>14</sub>N<sub>2</sub>O<sub>4</sub>S 258.3

NT57661

1mg	\$87.00
2mg	\$138.00
5mg	\$275.00

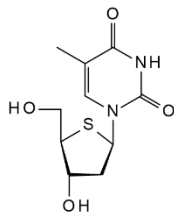
**α-Thio-dGTP**

see 2'-Deoxyguanosine-5'-O-(1-thiotriphosphate) lithium salt - 100mM aqueous solution, ND32068 on page 206

**α-Thio-GTP**

see Guanosine 5'-O-(1-thiotriphosphate) lithium salt - 100mM aqueous solution, NG58207 on page 285

**6-Thioguanosine-5'-O-diphosphate**[16541-19-8] C<sub>10</sub>H<sub>13</sub>N<sub>5</sub>O<sub>10</sub>P<sub>2</sub>S 459.27

NT36522

1mg	\$275.00
2mg	\$450.00
5mg	\$1000.00

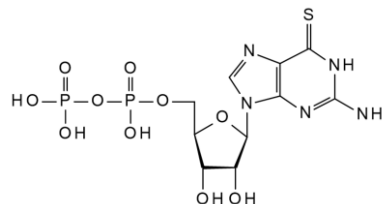
**6-Thioguanosine-5'-O-monophosphate sodium salt**[74686-78-5] C<sub>10</sub>H<sub>13</sub>N<sub>5</sub>O<sub>7</sub>PS·Na 401.27

NT11483

1mg	\$400.00
2mg	\$600.00
5mg	\$1250.00

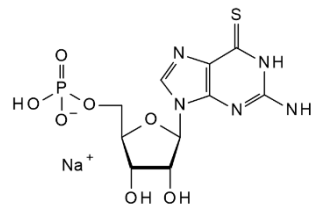
**6-Thioguanosine-5'-O-triphosphate sodium salt**[17670-19-8 (free acid)] C<sub>10</sub>H<sub>16</sub>N<sub>5</sub>O<sub>13</sub>P<sub>3</sub>S 539.25

NT36523

1mg	\$265.00
2mg	\$330.00
5mg	\$750.00

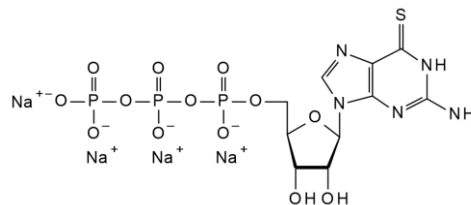

**Thioguanosin****4'-Thioguanosine**

• 4-Mercaptoguanosine

[74249-68-6] C<sub>10</sub>H<sub>13</sub>N<sub>5</sub>O<sub>4</sub>S 299.31

NG74932

Price On Application

**6-Thioguanosine**• 2-Amino-6-mercapto-9-(β-D-ribofuranosyl)purine  
• 6-Mercaptoguanosine[85-31-4][345909-25-3] C<sub>10</sub>H<sub>13</sub>N<sub>5</sub>O<sub>4</sub>S·xH<sub>2</sub>O 299.31 (anhydrous basis)

NT04480

100mg	\$40.00
250mg	\$70.00
500mg	\$120.00

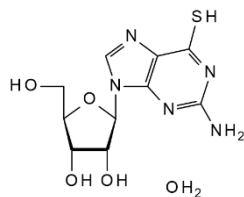
Refs: Szorcik A, Nagy L, Gajda-Schranz K, et al, *Academical Klado* 252, 3, p523**8-Thioguanosine**

• 8-Mercaptoguanosine

[26001-38-7] C<sub>10</sub>H<sub>13</sub>N<sub>5</sub>O<sub>3</sub>S 315.3

NT07601

5mg	\$65.00
10mg	\$110.00
25mg	\$190.00

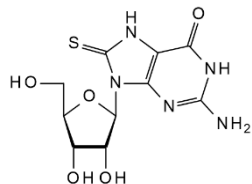
**6-Thioinosine 5'-monophosphate**[53-83-8] C<sub>10</sub>H<sub>13</sub>N<sub>4</sub>O<sub>7</sub>PS 364.27

NT10843

1mg	\$95.00
2mg	\$170.00
5mg	\$370.00

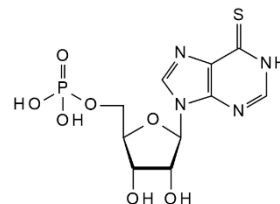
**6-Thioinosine**

• 6-Mercaptopurine riboside

[574-25-4][4988-64-1] C<sub>10</sub>H<sub>12</sub>N<sub>4</sub>O<sub>4</sub>S 284.29

NT08808

500mg	\$65.00
1g	\$115.00
2g	\$220.00

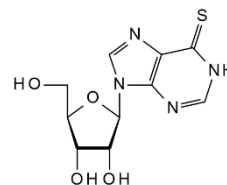
**Thionicotinamide adenine dinucleotide**

[4090-29-3]

NT71492

Price On Application

**4-(Thiophen-2-yl)pyrimidin-2-amine**

see 2-Amino-4-(thien-2-yl)pyrimidine, NA57407 on page 62

**4-(Thiophen-2-yl)pyrimidine-2-thiol**

see 4-(2-Thienyl)-2-pyrimidinethiol, NT57413 on page 358

**6-Thiopurine-2'-deoxyriboside**

see 6-Mercapto-9-(2'-deoxy-β-D-ribofuranosyl)purine, NM02964 on page 305

**6-Thiopurine-2',3'-dideoxyriboside**see *2',3'-Dideoxy-6-thio-inosine, ND45441* on page 246**2-Thiothymidine**[28585-51-5] C<sub>10</sub>H<sub>14</sub>N<sub>2</sub>O<sub>4</sub>S 258.3

NT02914	10mg	\$75.00
	25mg	\$125.00
	50mg	\$225.00



Refs: Nucleic Acids Res, 1989, 17, p4957

**4-Thiothymidine**[7236-57-9] C<sub>10</sub>H<sub>14</sub>N<sub>2</sub>O<sub>4</sub>S 258.3

NT06341	50mg	\$42.00
	100mg	\$63.00
	250mg	\$105.00

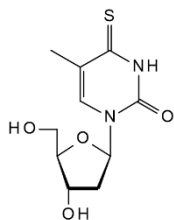

Refs: Neylon C, Cross H, Clark IP, Tavender SM, Parker AW, Central Laser Facility Report 2004/5, p163; J. Med. Chem, 1991, 34, p2361

**[1',2',3',4',5'-13C5]-4-Thiothymidine**

NT35287

Price On Application

**α-Thio-TTP**see *Thymidine-5'-O-(1-thiotriphosphate) lithium salt - 100mM aqueous solution, NT32067* on page 364**2-Thiouridine-5'-monophosphate triethylammonium salt - Aqueous solution**[29123-25-9 (free acid)] C<sub>21</sub>H<sub>43</sub>N<sub>4</sub>O<sub>8</sub>PS 542.63

NT29608

1mg	\$126.00
2mg	\$189.00
5mg	\$262.50

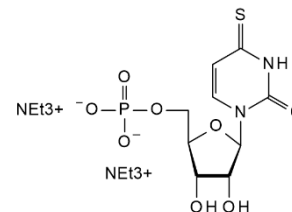
**2-Thio-uridine 2',3',5'-tribenzoate**see *2',3',5'-Tri-O-benzoyl-2-thiouridine, NT16569* on page 374**2-Thiouridine 2',3',5'-tribenzoate**see *2',3',5'-Tri-O-benzoyl-2-thiouridine, NT16569* on page 374**4-Thiouridine-5'-triphosphate sodium salt**[31556-28-2 (free acid)] C<sub>9</sub>H<sub>15</sub>N<sub>2</sub>O<sub>14</sub>P<sub>3</sub>S·4Na 592.17

NT34810

1mg	\$309.80
2mg	\$525.00
5mg	\$1100.00

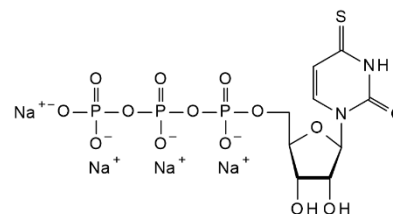
**2-Thiouridine**[20235-78-3] C<sub>9</sub>H<sub>12</sub>N<sub>2</sub>O<sub>5</sub>S 260.27

NT02881

50mg	\$115.50
100mg	\$184.00
250mg	\$395.00

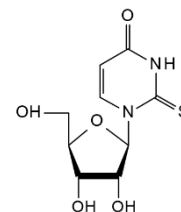

Refs: Nawrot B, et.al, Nucleosides Nucleotides, 1989, 8, p1499

**Thiouridine****4-Thiouridine**[13957-31-8] C<sub>9</sub>H<sub>12</sub>N<sub>2</sub>O<sub>5</sub>S 260.27

NT06186

100mg	\$75.00
250mg	\$125.00
500mg	\$195.00

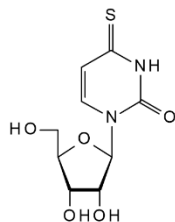

Refs: Sung WL, et.al, Chem. Comm, 1982, p522

**Thrombin**

[9002-04-4]

NT32354

Price On Application

**Thymidine-5'-diphosphate-6-deoxy-D-allose**

NT29841

5mg	\$1300.00
10mg	\$2350.00
25mg	\$5500.00

**α-Thio-UTP**see *Uridine 5'-O-(1-thiotriphosphate) lithium salt - 100mM aqueous solution, NU58208 on page 381***1-(β-L-Threonyl)cytosine**

NT137587

Price On Application

**Thymidine-5'-diphosphate-2-deoxy-D-glucose disodium salt**C<sub>16</sub>H<sub>24</sub>N<sub>2</sub>O<sub>15</sub>P<sub>2</sub>Na<sub>2</sub> 592.29

NT29842

1mg	\$210.00
2mg	\$315.00
5mg	\$590.00

**1-(β-L-Threonyl)-5-methyluracil**

NT137585

Price On Application

**Thymidine-3',5'-diphosphate disodium salt**[386229-77-2][108322-12-9] C<sub>10</sub>H<sub>14</sub>N<sub>2</sub>Na<sub>2</sub>O<sub>11</sub>P<sub>2</sub> 446.15

NT07359

1mg	\$500.00
2mg	\$900.00
5mg	\$1900.00

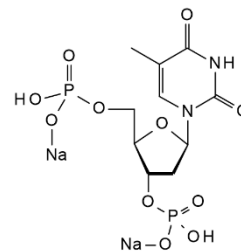

Refs: Folkman W, et.al, Chem. Res. Toxicol, 1990, 3, p536

**1-(β-L-Threonyl)uracil**

NT137586

Price On Application



## Thymidine-5'-diphosphate-D-fucosamine

NT29843	5mg	\$1300.00
	10mg	\$2350.00
	25mg	\$5500.00



## Thymidine-5'-diphosphate-b-L-fucose

• TDP-Fucose

Price On Application

NT04379



## Thymidine-5'-diphosphate-a-D-glucose disodium salt

• dTDP-a-glc-Na2

[148296-43-9] C<sub>16</sub>H<sub>24</sub>N<sub>2</sub>Na<sub>2</sub>O<sub>16</sub>P<sub>2</sub> 608.29

NT46685	5mg	\$250.00
	10mg	\$450.00
	25mg	\$750.00



## Thymidine-5'-diphosphate-4-keto-6-deoxy-D-glucose disodium salt

[16752-71-9] C<sub>16</sub>H<sub>22</sub>N<sub>2</sub>O<sub>15</sub>P<sub>2</sub>Na<sub>2</sub> 590.28

NT29846	1mg	\$79.00
	2mg	\$124.00
	5mg	\$240.00



## Thymidine-5'-diphosphate-L-rhamnose disodium salt

• dTDP-L-rhamnose

[2147-59-3][16268-29-4] C<sub>16</sub>H<sub>24</sub>N<sub>2</sub>O<sub>15</sub>P<sub>2</sub>Na<sub>2</sub> 592.29

NT29845	250ug	\$50.00
	500ug	\$80.00
	1mg	\$131.00



## Thymidine-3',5'-diphosphate sodium salt

• 2'-Deoxythymidine-3',5'-bisphosphate

[2863-04-9] C<sub>10</sub>H<sub>16</sub>N<sub>2</sub>O<sub>11</sub>P<sub>2</sub>·xNa 402.19 (free acid basis)

NT09781	500ug	\$175.00
	1mg	\$275.00
	2mg	\$500.00

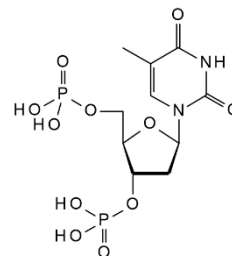

Refs: Hinton et.al., *Biochemistry*, 17, 5091 - 5097 (1978); Cuatrecasas et.al., *J. Biol. Chem.*, 242, 3063 - 3067 (1967).

## Thymidine-5'-diphosphate trisodium salt

[95648-78-5] C<sub>10</sub>H<sub>13</sub>N<sub>2</sub>Na<sub>3</sub>O<sub>11</sub>P<sub>2</sub> 468.13

NT13491	25mg	\$73.50
	50mg	\$115.50
	100mg	\$210.00



## Thymidine-5'-diphosphate-D-viosamine disodium salt

[244226-72-0] C<sub>16</sub>H<sub>25</sub>N<sub>3</sub>O<sub>14</sub>P<sub>2</sub>Na<sub>2</sub> 591.31

NT29844	5mg	\$1300.00
	10mg	\$2075.00
	25mg	\$4375.00



**Thymidinemon****Thymidine-5'-monophosphate disodium salt**[33430-62-5] C<sub>10</sub>H<sub>13</sub>N<sub>2</sub>Na<sub>2</sub>O<sub>8</sub>P 366.17

NT02975

1g	\$50.00
2g	\$90.00
5g	\$200.00

**L-Thymidine-5'-monophosphate sodium salt**

NT16126

25mg	\$262.50
50mg	\$420.00
100mg	\$630.00

**Thymidine 3'-monophosphate sodium salt**

[108320-91-8]

NT156795

50mg	\$550.00
100mg	\$850.00
250mg	\$1625.00

**Thymidine-5'-monophosphate**

• 5'-Thymidylic acid

[365-07-1] C<sub>10</sub>H<sub>13</sub>N<sub>2</sub>O<sub>8</sub>P 322.21

NT32262

Price On Application

**Thymidine-3',5'-tetrabenzylidiphosphate**

• Tetrabenzyl-D-thymidine-3',5'-diphosphate

C<sub>38</sub>H<sub>40</sub>N<sub>2</sub>O<sub>11</sub>P<sub>2</sub> 762.68

NT07361

5mg	\$110.30
10mg	\$183.80
25mg	\$420.00

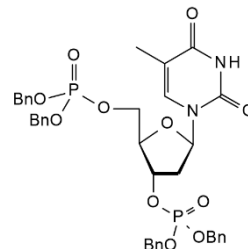

Refs: Folkman W, et al, Chem. Res. Toxicol, 1990, 3, p536

**Thymidine-5'-O-(1-thiotriphosphate) lithium salt - 100mM aqueous solution**

• α-Thio-TTP

C<sub>10</sub>H<sub>17</sub>N<sub>2</sub>O<sub>13</sub>P<sub>3</sub>S·xLi 498.23 (free acid basis)

NT32067

Price On Application

**Thymidine 5'-triphosphate lithium salt - 100mM aqueous solution**

• dTTP.Li

[3624-46-2] C<sub>10</sub>H<sub>17</sub>N<sub>2</sub>O<sub>14</sub>P<sub>3</sub>·xLi 482.17 (free acid basis)

ND46293

20mg	\$70.00
40mg	\$120.00

**L-Thymidine-5'-triphosphate sodium salt**

NT16143

5mg	\$393.80
10mg	\$630.00
25mg	\$1312.50



T



## Thymidine

## Thymidine-5'-triphosphate sodium salt - 100mM aqueous solution

• dTTP.Na

[3624-46-2][365-08-2]	C <sub>10</sub> H <sub>17</sub> N <sub>2</sub> O <sub>14</sub> P <sub>3</sub> ·xNa	482.17 (free acid basis)	
		20mg	\$70.00
NT10135		40mg	\$120.00
		90mg	\$225.00

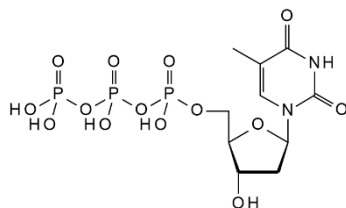

## D3-Thymidine

[74848-84-3] C<sub>10</sub>H<sub>11</sub>N<sub>2</sub>O<sub>5</sub>D<sub>3</sub> 245.25

NT08812

1mg	\$75.00
2mg	\$125.00
5mg	\$235.00

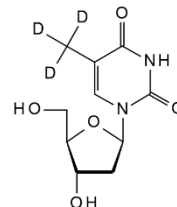

## Thymidine-5'-triphosphate trisodium salt

• TTP

[18423-43-3]	C <sub>10</sub> H <sub>14</sub> N <sub>2</sub> O <sub>14</sub> P <sub>3</sub> ·3Na	548.12	
		50mg	\$85.00
NT05748		100mg	\$150.00
		250mg	\$275.00

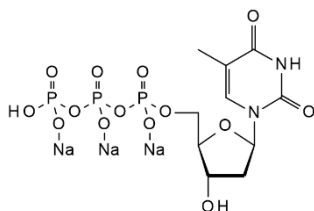

## L-Thymidine

- 1-(2-deoxy-b-L-erythro-pentofuranosyl)thymine
- 2'-Deoxy-L-thymidine
- Telbivudine

[3424-98-4] C<sub>10</sub>H<sub>14</sub>N<sub>2</sub>O<sub>5</sub> 242.23

NT02679

1g	\$40.00
2g	\$75.00
5g	\$165.00

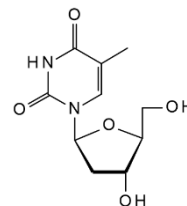

Refs: Bryant ML, Bridges EG, Placidi L, Faraj A, Loi A-G, Pierra C, Dukhan D, Gosselin G, Imbach J-L, Hernandez B, Antimicrob. Agents Chemother. 2001, Vol45, Pt1, p229-235; Yamaguchi T, Saneyoshi M, Shudo K, Nucleic Acids Symp. Series 1993, Vol29, p135

## a-Thymidine

- 1-(2-Deoxy-a-D-ribofuranosyl)-5-methyluracil

[4449-43-8]	C <sub>10</sub> H <sub>14</sub> N <sub>2</sub> O <sub>5</sub>	242.23	
		100mg	\$84.00
NT00283		250mg	\$132.50
		500mg	\$210.00

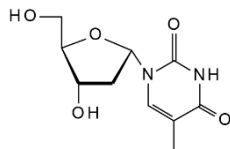

## Thymidine

- 1-(2-Deoxy-b-D-ribofuranosyl)-5-methyluracil
- 2'-Deoxy-D-thymidine
- b-Thymidine

[50-89-5] C<sub>10</sub>H<sub>14</sub>N<sub>2</sub>O<sub>5</sub> 242.23

NT02592

25g	\$45.00
50g	\$75.00
100g	\$120.00

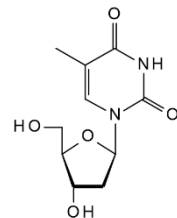

Refs: Tollin, et al, Nature 1968, 217, p1148

## b-Thymidine

see *Thymidine*, NT02592 on page 365

**Thymidine****Thymidine-a,a,a,6-D4**[347841-67-2] C<sub>10</sub>H<sub>10</sub>N<sub>2</sub>O<sub>5</sub>D<sub>4</sub> 246.25

NT29046

5mg	\$393.80
10mg	\$619.50
20mg	\$1081.60

**5'-Thymidylic acid**see *Thymidine-5'-monophosphate*, NT32262 on page 364**Thymidylyl-(3'-5')-2'-deoxyadenosine ammonium salt**[61845-39-4] C<sub>20</sub>H<sub>26</sub>N<sub>7</sub>O<sub>10</sub>P·NH<sub>3</sub> 572.47

NT08058

1mg	\$95.00
2mg	\$170.00
5mg	\$325.00

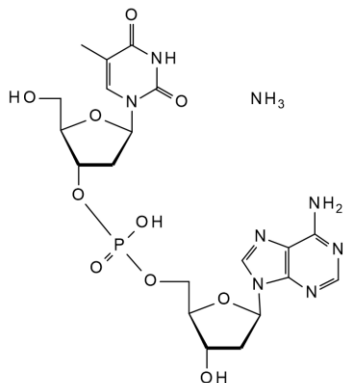
**Thymidylyl-3'-5'-thymidine ammonium salt**

• TpT

[1969-54-6] C<sub>20</sub>H<sub>27</sub>N<sub>4</sub>O<sub>12</sub>P·NH<sub>3</sub> 563.45

NT07991

1mg	\$95.00
2mg	\$170.00
5mg	\$350.00

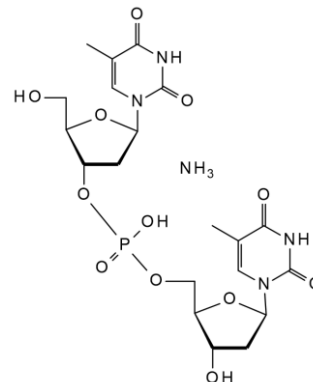
**Thymine 1-b-D-arabinofuranoside**see *1-(b-D-Arabinofuranosyl)thymine*, NA08059 on page 74**[(2S,6R)-6-(Thymin-1-yl)-4-tritylmorpholin-2-yl]methyl dimethylphosphoramidochloridate**[956139-30-3] C<sub>31</sub>H<sub>34</sub>ClN<sub>4</sub>O<sub>5</sub>P 609.05

NT58203

Price On Application

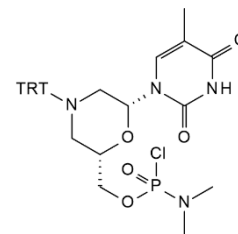
**3',5'-O-TIPPS-N4-acetylcytidine**see *N4-Acetyl-3',5'-O-(1,1,3,3-tetraisopropyl-1,3-disiloxanediyl)cytidine*, NA09329 on page 20**3',5'-TIPPS-D-adenosine**see *3',5'-O-(1,1,3,3-Tetraisopropyl-1,3-disiloxanediyl)adenosine*, NT08580 on page 355

**3',5'-O-TIPPS-N6-benzoyladosine**

see *N6-Benzoyl-3',5'-O-(1,1,3,3-tetraisopropyl-1,3-disiloxanediyl)adenosine*, NB09330 on page 113

**3',5'-TIPPS-2,6-diaminopurine riboside**

see *2,6-Diamino-9-[3',5'-O-(1,1,3,3-tetraisopropyl-1,3-disiloxanediyl)-b-D-ribofuranosyl]purine*, ND08565 on page 232

**3',5'-O-TIPPS-guanosine**

see *3',5'-O-(1,1,3,3-Tetraisopropyl-1,3-disiloxanediyl)guanosine*, NT08583 on page 355

**3',5'-O-TIPPS-N2-isobutyrylguanosine**

see *N2-Isobutyryl-3',5'-O-(1,1,3,3-tetraisopropyl-1,3-disiloxanediyl)guanosine*, NI09331 on page 297

**3',5'-TIPPS-uridine**

see *3',5'-O-(1,1,3,3-Tetraisopropyl-1,3-disiloxanediyl)uridine*, NT08582 on page 356

**3',5'-TIPS-cytidine**

see *3',5'-O-(1,1,3,3-Tetraisopropyl-1,3-disiloxanediyl)cytidine*, NT08581 on page 355

**TNP-ADP**

see *2'/3'-O-Trinitrophenyl-adenosine-5'-diphosphate triethylammonium salt*, NT29596 on page 377

**TNP-AMP**

see *2',3'-O-Trinitrophenyl-adenosine-5'-monophosphate triethylammonium salt*, NT29595 on page 377

**5'-O-(p-Toluenesulfonyl)adenosine**

see *5'-Tosyladenosine*, NT07155 on page 368

**m-Topolin riboside-5'-monophosphate salt**

- 6-(3-Hydroxybenzylamino)-9-b-D-ribofuranosylpurine-5'-monophosphate disodium monohydrate
- N6-(3-Hydroxybenzyl)adenosine-5'-monophosphate

[946853-27-6] C<sub>17</sub>H<sub>18</sub>N<sub>5</sub>Na<sub>2</sub>O<sub>8</sub>P·H<sub>2</sub>O 515.32 5mg \$1750.00  
NT30285

**o-Topolin riboside-5'-monophosphate sodium salt**

- 6-(2-Hydroxybenzylamino)-9-b-D-ribofuranosylpurine-5'-monophosphate disodium monohydrate
- N6-(2-Hydroxybenzyl)adenosine-5'-monophosphate

[1242061-01-3] C<sub>17</sub>H<sub>18</sub>N<sub>5</sub>Na<sub>2</sub>O<sub>8</sub>P·H<sub>2</sub>O 515.32 5mg \$1750.00  
NT30289

**p-Topolin riboside-5'-monophosphate sodium salt**

- 6-(4-Hydroxybenzylamino)-9-b-D-ribofuranosylpurine-5'-monophosphate disodium monohydrate
- N6-(4-Hydroxybenzyl)adenosine-5'-monophosphate

C<sub>17</sub>H<sub>18</sub>N<sub>5</sub>Na<sub>2</sub>O<sub>8</sub>P·H<sub>2</sub>O 515.32 5mg \$1750.00  
NT30293

**m-Topolin riboside**

- N6-(3-Hydroxybenzyl)adenosine
- 6-(3-Hydroxybenzylamino)-9-b-D-ribofuranosylpurine

[110505-76-5] C<sub>17</sub>H<sub>19</sub>N<sub>5</sub>O<sub>5</sub> 373.36 100mg \$190.00  
250mg \$300.00  
500mg \$450.00  
NT30283

**o-Topolin riboside**

- N6-(2-hydroxybenzyl)adenosine
- 6-(2-Hydroxybenzylamino)-9-b-D-ribofuranosylpurine

[50868-58-1] C<sub>17</sub>H<sub>19</sub>N<sub>5</sub>O<sub>5</sub> 373.36 100mg \$250.00  
250mg \$375.00  
500mg \$625.00  
NT30288



**Topolinribos****p-Topolin riboside**

- N6-(4-Hydroxybenzyl)adenosine
- 6-(4-Hydroxybenzylamino)-9-b-D-ribofuranosylpurine

[110505-75-4][23666-24-2] C<sub>17</sub>H<sub>19</sub>N<sub>5</sub>O<sub>5</sub> 373.36

NT30291	25mg	\$73.50
	50mg	\$126.00
	100mg	\$210.00

**5'-Tosyladenosine**

- 5'-O-(p-Toluenesulfonyl)adenosine

[5135-30-8] C<sub>17</sub>H<sub>19</sub>N<sub>5</sub>O<sub>6</sub>S 421.43

NT07155	5g	\$60.00
	10g	\$100.00
	25g	\$200.00

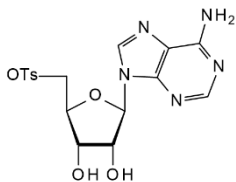
**5'-Tosyl-2'-deoxy adenosine**

[6698-29-9]

NT139052

Price On Application

**5'-Tosyl-2'-deoxy cytidine**

- 5'-(4-Methylbenzenesulfonate)

[27999-55-9] C<sub>16</sub>H<sub>18</sub>N<sub>3</sub>O<sub>5</sub>S 365.41

NT16566

Price On Application

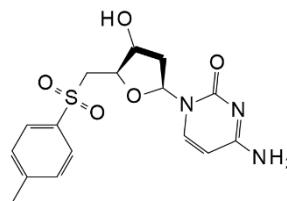

Refs: Krug, F, et al, J. Biol. Chem, 248, 1203

**5'-O-Tosyl-2',3'-O-isopropylideneadenosine**

NT15541

1g	\$294.00
2g	\$546.00
5g	\$1260.00

**5'-O-Tosylthymidine**[7253-19-2] C<sub>17</sub>H<sub>20</sub>N<sub>2</sub>O<sub>7</sub>S 396.42

NT10016

100mg	\$132.00
250mg	\$262.50
500mg	\$420.00

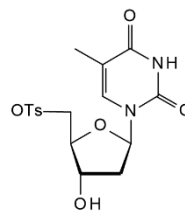

T

**Toyocamycin**

- 4-Amino-5-cyano-7-(b-D-ribofuranosyl)pyrrolo[2,3-d]pyrimidine
- Vengicide
- 7-Deaza-7-cyanoadenosine

[606-58-6] C<sub>12</sub>H<sub>13</sub>N<sub>5</sub>O<sub>4</sub>·H<sub>2</sub>O 309.28

NT44985	5mg	\$60.00
	10mg	\$95.00
	25mg	\$175.00

**TrpT**see *Thymidyl-3'-5'-thymidine ammonium salt, NT07991 on page 366***2,3,5-Tri-O-acetyl a-adenosine**

- 9-(2,3,5-Tri-O-acetyl-a-D-ribofuranosyl)-9H-purin-6-amine

[953089-09-3] C<sub>16</sub>H<sub>19</sub>N<sub>5</sub>O<sub>7</sub> 393.35

NT28569	2mg	\$174.90
	5mg	\$318.00
	10mg	\$578.20

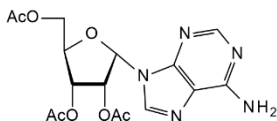

Refs: Ciuffreda, P. et al, Mag, Reson. Chem, 45, 781 (2007); Long, X. et al, J. Pharmacol. Exper. Ther, 335, 781 (2010); Ham, M. et al, J. Pharmacol. Exper. Ther, 335, 607 (2010)

**2',3',5'-Tri-O-acetyladenosine**[7387-57-7] C<sub>16</sub>H<sub>19</sub>N<sub>5</sub>O<sub>7</sub> 393.35

NT04548	250mg	\$60.00
	500mg	\$90.00
	1g	\$150.00

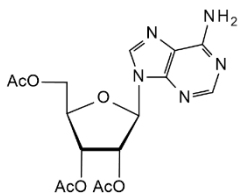

Refs: Wilson CC, Tollin P, Howie RA, Cryst. Struct. Commun. 1986, C42, 697-700

**1-(2',3',5'-Tri-O-acetyl-b-D-arabinofuranosyl)uracil**

NT145609

1g	\$50.00
2g	\$90.00
5g	\$205.00

**2',3',5'-Triacetyl -azacytidine**[10302-78-0] C<sub>14</sub>H<sub>18</sub>N<sub>4</sub>O<sub>8</sub> 370.31

NT57363	10mg	\$70.00
	25mg	\$125.00
	50mg	\$185.00

**2',3',5'-Tri-O-acetyl-6-azauridine**

- (-)-6-Azauridine 2',3',5'-triacetate

[2169-64-4] C<sub>14</sub>H<sub>17</sub>N<sub>5</sub>O<sub>9</sub> 371.3

NT32421	1g	\$90.00
---------	----	---------

**2',3',5'-Tri-O-acetyl-8-bromoguanosine**[15717-45-0] C<sub>16</sub>H<sub>18</sub>BrN<sub>5</sub>O<sub>8</sub> 488.25

NT05775	500mg	\$85.00
	1g	\$156.00
	2g	\$175.00

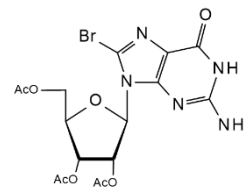

Refs: Homes RE, Robins RK, J. Am. Chem. Soc. 1964, 86, p1242

## Triacetylbro

**2',3',5'-Tri-O-acetyl-5-bromouridine**

• 5-Bromo-2',3',5'-tri-O-acetyluridine

[105659-32-3]

NT15543

1g	\$150.00
2g	\$250.00
5g	\$380.00

**2',3',5'-Tri-O-acetyl-2-chloroadenosine**• 6-Amino-2-chloro-9-(2',3',5'-tri-O-acetyl-β-D-ribofuranosyl)purine  
• 2-Chloro-adenosine 2',3',5'-triacetate[79999-39-6] C<sub>16</sub>H<sub>18</sub>ClN<sub>5</sub>O<sub>7</sub> 427.8

NT20146

500mg	\$145.00
1g	\$210.00
2g	\$378.00

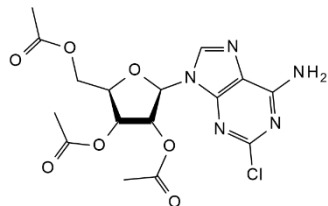
**2',3',5'-Tri-O-acetyl-6-chloro-6-deoxyguanosine**[16321-99-6] C<sub>16</sub>H<sub>18</sub>ClN<sub>5</sub>O<sub>7</sub> 427.8

NT04678

500mg	\$85.00
1g	\$150.00
2g	\$250.00

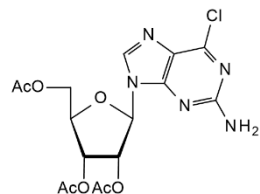
**2',3',5'-Tri-O-acetyl-6-chloroinosine**

see 9-(2',3',5'-Tri-O-acetyl-β-D-ribofuranosyl)-6-chloropurine, NT10156 on page 372

**2',3',5'-Tri-O-acetyl- 6-Chloro-9-(β-D-ribofuranosyl) purine**

see 9-(2',3',5'-Tri-O-acetyl-β-D-ribofuranosyl)-6-chloropurine, NT10156 on page 372

**2',3',5'-Tri-O-acetylcytidine HCl**[63639-21-4] C<sub>15</sub>H<sub>19</sub>N<sub>3</sub>O<sub>8</sub>·HCl 405.79

NT07958

50mg	\$89.50
100mg	\$168.00
250mg	\$315.00

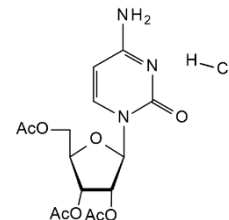
**N2,3',5'-Tri-O-acetyl-2'-deoxy-05-diphenylcarbamoyl-a/b-guanosine**

NT145602

10mg	\$50.00
25mg	\$115.00
50mg	\$210.00

**3',5',N2-Tri-O-acetyl-2'-deoxyguanosine**

• N-Acetyl-2'-deoxy-guanosine 3',5'-diacetate

[193092-29-4] C<sub>16</sub>H<sub>19</sub>N<sub>5</sub>O<sub>7</sub> 393.35

NT16879

10mg	\$139.80
25mg	\$254.50
50mg	\$462.00

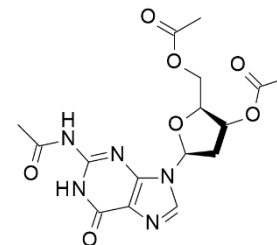

Refs: Mounetou, E, et al, J. Med. Chem, 40, 2902 (1997); Perrino, F, et al, Chem. Res. Toxicol, 18, 1451 (2005)

**2',3',5'-Tri-O-acetyl-2N,2N-dimethylguanosine**

• N,N-Dimethyl-guanosine 2',3',5'-triacetate

[73196-87-9] C<sub>18</sub>H<sub>23</sub>N<sub>5</sub>O<sub>8</sub> 437.4

NT16567	25mg	\$110.00
	50mg	\$175.00
	100mg	\$295.00

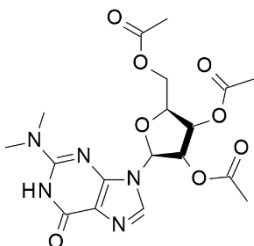
**2',3',5'-Tri-O-acetyl-N2-dimethylguanosine**[73196-87-9] C<sub>18</sub>H<sub>23</sub>N<sub>5</sub>O<sub>8</sub> 437.4

NT07343	10mg	\$89.30
	25mg	\$157.50
	50mg	\$262.50

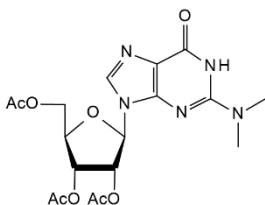
**2',3',5'-Tri-O-acetyl-2-fluoroadenosine**[15811-32-2] C<sub>16</sub>H<sub>18</sub>FN<sub>5</sub>O<sub>7</sub> 411.34

NT09632	1g	\$95.00
	2g	\$170.00
	5g	\$325.00

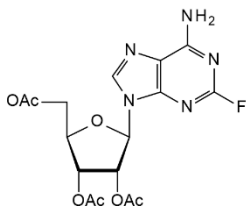
**2',3',5'-Tri-O-acetylguanosine**

• Guanosine Triacetate

[6979-94-8] C<sub>16</sub>H<sub>19</sub>N<sub>5</sub>O<sub>8</sub> 409.35

NT06136	5g	\$31.50
	10g	\$52.50
	25g	\$100.00

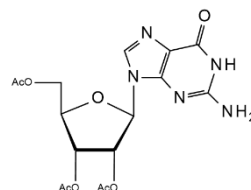

Refs: Niles JC, Wishnok JS, Tannenbaum SR, J. Am. Chem. Soc. 2001, Vol123, Pt49, p12147-12151

**2',3',5'-Tri-O-acetylinosine**[3181-38-2] C<sub>16</sub>H<sub>18</sub>N<sub>4</sub>O<sub>8</sub> 394.34

NT06708	1g	\$36.80
	2g	\$57.80
	5g	\$89.30

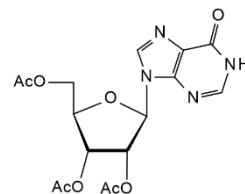

Refs: Veliz EA, Beal PA, Tetrahedron Lett. 2000, Vol41, Pt11, p1695-1698

**2',3',5'-Tri-O-acetyl-5-iodouridine**

NT15542

Price On Application



## Triacetylislo

**2',3',5'-Tri-O-acetylisoguanosine**

• Isoguanosine triacetate

C<sub>16</sub>H<sub>19</sub>N<sub>5</sub>O<sub>8</sub> 409.35

NT07233

25mg	\$89.50
50mg	\$168.00
100mg	\$263.00

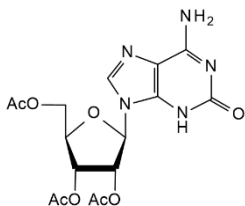
**1-(2,3,5-Tri-O-acetyl-b-D-ribofuranosyl)nicotinamide**

• Nicotinamide 2,3,5-tri-O-acetyl-b-D-ribofuranose

C<sub>17</sub>H<sub>21</sub>N<sub>2</sub>O<sub>8</sub> 381.36

NT08585

Price On Application

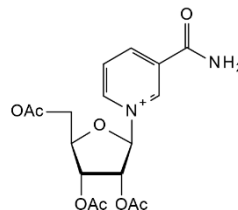
**2',3',5'-Tri-O-acetyl-6-mercaptoguanosine**

see 2-Amino-6-mercapto-9-(2',3',5'-tri-O-acetyl-b-ribofuranosyl)purine, NA06751 on page 57

**2',3',5'-Tri-O-acetylnebularine**

- 9-b-D-Ribofuranosylpurine triacetate
- 9-(2,3,5-Tri-O-acetyl-b-D-ribofuranosyl)purine
- 2',3',5'-Tri-O-acetylnebularine

[15981-63-29] C<sub>18</sub>H<sub>18</sub>N<sub>4</sub>O<sub>7</sub> 378.34

NT16568

100mg	\$112.00
250mg	\$202.50
500mg	\$370.00

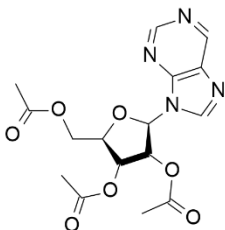
**9-(2,3,5-Tri-O-acetyl-a-D-ribofuranosyl)-9H-purin-6-amine**

see 2,3,5-Tri-O-acetyl a-adenosine, NT28569 on page 369

**9-(2,3,5-Tri-O-acetyl-b-D-ribofuranosyl)purine**

see 2',3',5'-Tri-O-acetylnebularine, NT16568 on page 372

**2',3',5'-Tri-O-acetyl-N1-tritylinosine**

NT145606

500mg	\$50.00
1g	\$90.00
2g	\$166.00

**2',3',5'-Tri-O-acetyluridine**

• Uridine 2',3',5'-triacetate

[4105-38-8] C<sub>15</sub>H<sub>18</sub>N<sub>2</sub>O<sub>9</sub> 370.31

NT06907

50g	\$55.00
100g	\$90.00
250g	\$180.00

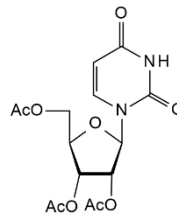
**9-(2',3',5'-Tri-O-acetyl-b-D-ribofuranosyl)-6-chloropurine**

- 2',3',5'-Tri-O-acetyl-6-chloroinosine
- 2',3',5'-Tri-O-acetyl-6-Chloro-9-(beta-D-ribofuranosyl) purine

[5987-73-5] C<sub>16</sub>H<sub>17</sub>ClN<sub>4</sub>O<sub>7</sub> 412.78

NT10156

1g	\$50.00
2g	\$80.00
5g	\$100.00

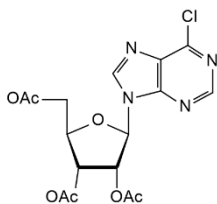



**1,2,3-Triazole-4-carboxamide, 5-b-D-ribofuranosyl-5'-triphosphate-nucleoside triethyl ammonium salt**C<sub>8</sub>H<sub>12</sub>N<sub>4</sub>O<sub>14</sub>P<sub>3</sub> 481.12

Price On Application

NT29258

**[1,2,4]Triazolo[1,5-a]pyrimidine-2-carboxylic acid**[202065-25-6] C<sub>6</sub>H<sub>4</sub>N<sub>4</sub>O<sub>2</sub> 164.12

NT57365

100mg	\$126.00
250mg	\$230.00
500mg	\$320.00

**2',3',5'-Tri-O-benzoyl-N6-benzyl-2'-C-methyladenosine**[74829-55-3] C<sub>39</sub>H<sub>33</sub>N<sub>5</sub>O<sub>7</sub> 683.71

NT45806

10mg	\$95.00
25mg	\$200.00
50mg	\$350.00

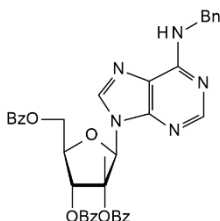
**2',3',5'-Tri-O-benzoyl-3-deazauridine**

• 4-Hydroxy-1-(2,3,5-tri-O-benzoyl-b-D-ribofuranosyl)-2(1H)-pyridinone

[23220-74-8] C<sub>31</sub>H<sub>25</sub>NO<sub>9</sub> 555.53

NT58307

100mg	\$150.00
250mg	\$300.00
500mg	\$450.00

**2',3',5'-Tri-O-benzoyl-4'-C-fluoroadenosine**

[1000203-40-6]

NT76128

Price On Application

**2',3',5'-Tri-O-benzoylguanosine**[66048-53-1] C<sub>31</sub>H<sub>25</sub>N<sub>5</sub>O<sub>8</sub> 595.56

NT05368

100mg	\$90.00
250mg	\$157.50
500mg	\$265.00

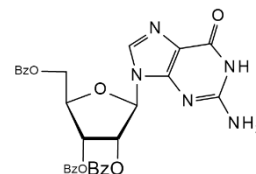
**2',3',5'-Tri-O-benzoyl-2'-C-methylcytidine**

• 1-(2,3,5-Tri-O-benzoyl-2-C-methyl-b-D-ribofuranosyl)cytosine

[640725-69-5] C<sub>31</sub>H<sub>27</sub>N<sub>5</sub>O<sub>8</sub> 569.56

NT06137

5mg	\$65.00
10mg	\$97.50
25mg	\$162.50

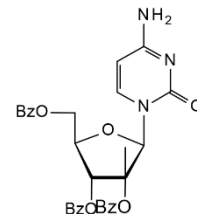
**1-(2,3,5-Tri-O-benzoyl-2-C-methyl-b-D-ribofuranosyl)cytosine**

see 2',3',5'-Tri-O-benzoyl-2'-C-methylcytidine, NT06137 on page 373

**Tribenzoylme****2',3',5'-Tri-O-benzoyl-2'-C-methyluridine**[23643-36-9] C<sub>31</sub>H<sub>26</sub>N<sub>2</sub>O<sub>9</sub> 570.55

NT07136

Price On Application

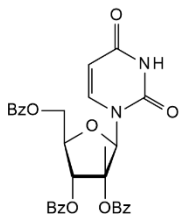
**2',3',5'-Tri-O-benzoyl-6-methyluridine**C<sub>31</sub>H<sub>26</sub>N<sub>2</sub>O<sub>9</sub> 570.55

NT08584

Price On Application

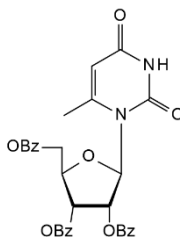
**2',3',5'-Tri-O-benzoyl-2-thiouridine**

- 2-Thio-uridine 2',3',5'-tribenzoate
- 2-Thiouridine 2',3',5'-tribenzoate

[21052-18-6] C<sub>30</sub>H<sub>24</sub>N<sub>2</sub>O<sub>8</sub>S 572.59

NT16569

50mg	\$95.00
100mg	\$125.00
250mg	\$310.00

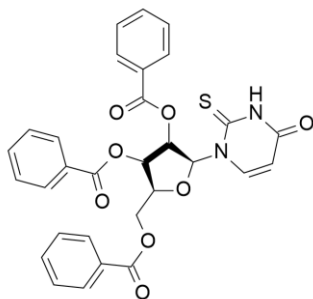

Refs: El-Tayeb, A, et al, J. Med. Chem, 49, 7076 (2006)

**2',3',5'-Tri-O-benzoyluridine**[1748-04-5] C<sub>30</sub>H<sub>24</sub>N<sub>2</sub>O<sub>9</sub> 556.52

NT08060

250mg	\$40.00
500mg	\$75.00
1g	\$118.00

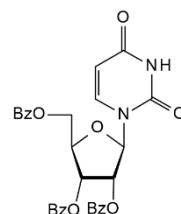
**9-(2',3',5'-Tri-O-benzoyl-b-D-arabinofuranosyl)adenine**[3257-73-6] C<sub>31</sub>H<sub>31</sub>N<sub>5</sub>O<sub>4</sub> 537.61

NT05401

5g	\$89.30
10g	\$168.00
25g	\$315.00

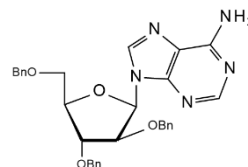
**2,4,6-Tribromopyrimidine**[36847-11-7] C<sub>4</sub>HBr<sub>3</sub>N<sub>2</sub> 316.78

NT57417

1g	\$83.60
2g	\$133.70
5g	\$362.50



**1-(2',3',5'-Tri-O-tert-butylidimethylsilyl-b-D-ribofuranosyl)-5-ethynylimidazo-4-carbonitrile**C<sub>29</sub>H<sub>53</sub>N<sub>3</sub>O<sub>4</sub>Si<sub>3</sub> 592.01

NT09943

1mg	\$84.00
2mg	\$126.00
5mg	\$210.00

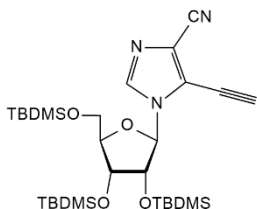
**2',3',5'-Tri-O-(p-chlorobenzoyl)-5-azacytidine**C<sub>29</sub>H<sub>21</sub>Cl<sub>3</sub>N<sub>4</sub>O<sub>8</sub> 659.86

NT07351

250mg	\$92.50
500mg	\$160.00
1g	\$262.50

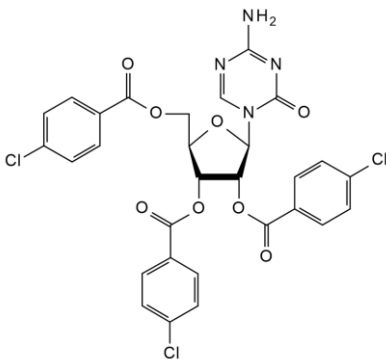
**2,4,6-Trichloro-5-methylpyrimidine**[1780-36-5] C<sub>5</sub>H<sub>3</sub>Cl<sub>3</sub>N<sub>2</sub> 197.45

NT67801

5g	\$75.00
10g	\$145.00
25g	\$350.00

**Triciribine Phosphate**see *Tricyclic nucleoside phosphate*, NT44794 on page 375**Triciribine**

- 6-Amino-4-methyl-8-(b-D-ribofuranosyl)4H,8H-pyrrolo[4,3,2-de]pyrimido[4,5-c] pyridazine
- Tricyclic Nucleoside

[35943-35-2] C<sub>13</sub>H<sub>16</sub>N<sub>6</sub>O<sub>4</sub> 320.3

NT08796

1mg	\$50.00
2mg	\$90.00
5mg	\$145.00

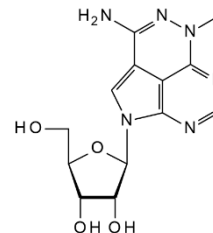
**Tricyclic nucleoside phosphate**

- Triciribine Phosphate
- 6-Amino-4-methyl-8-(b-D-ribofuranosyl)-4H,8H-pyrrolo[4,3,2-de]pyrimido[4,5-c]pyridazine 5'-monophosphate

[61966-08-3] C<sub>13</sub>H<sub>17</sub>N<sub>6</sub>O<sub>7</sub>P 400.28

NT44794

5mg	\$250.00
10mg	\$395.00

**Tricyclic Nucleoside**see *Triciribine*, NT08796 on page 375**Trifluoridine**see *Trifluorothymidine*, NT04884 on page 376**5-(Trifluoromethyl)-2'-deoxycytidine**[66384-66-5] C<sub>10</sub>H<sub>12</sub>F<sub>3</sub>N<sub>3</sub>O<sub>4</sub> 295.22

NT11494

Price On Application

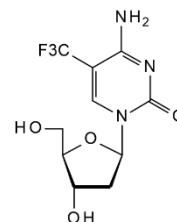

**Trifluoromet****6-(Trifluoromethyl)uracil**

• 6-(Trifluoromethyl)-2,4-pyrimidinediol

[672-45-7] C<sub>5</sub>H<sub>3</sub>F<sub>3</sub>N<sub>2</sub>O<sub>2</sub> 180.08

ND57450

250mg	\$85.00
500mg	\$135.00
1g	\$213.90

**a,a,a-Trifluorothymidine**see *Trifluorothymidine*, NT04884 on page 376**Trifluorothymidine**

- Trifluoridine
- Trifluorothymine deoxyriboside
- a,a,a-Trifluorothymidine

[70-00-8] C<sub>10</sub>H<sub>11</sub>F<sub>3</sub>N<sub>2</sub>O<sub>5</sub> 296.2

NT04884

500mg	\$50.00
1g	\$90.00
2g	\$160.00

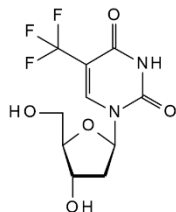

Refs: Wellings PC, Awdry PN, Bors FH, Jones BR, Brown DC, Kaufman HE, Am. J. Ophthalmol. 1972, Jun, 73(6), 932-42

**Trifluorothymine deoxyriboside**see *Trifluorothymidine*, NT04884 on page 376**Trifluridine Related Compound A**see *5-Carboxy-2'-deoxyuridine*, NC58344 on page 137**Trilithium coenzyme A**see *Coenzyme A trilithium salt*, NC20534 on page 155**2,4,6-Trimethoxy-pyrimidine**

[13106-85-9]

NT44266

Price On Application

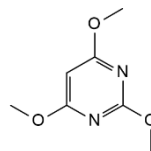
**N6,N6,2'-O-Trimethyladenosine**

NT59826

500mg	\$2750.00
1g	\$3890.00
2g	\$6500.00

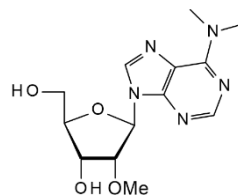
**N2,N2,7-Trimethylguanosine**[40027-70-1] C<sub>13</sub>H<sub>19</sub>N<sub>5</sub>O<sub>5</sub> 325.32

NT08918

1.5mg	\$285.00
3mg	\$525.00
8mg	\$1340.00

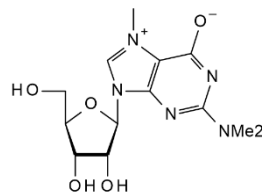

Refs: Bahia et.al, Nucleosides, Nucleotides &amp; Nucleic Acids 2006, 25, p909

**5-(2-(Trimethylsilyl)-1-ethynyl)-1-(2',3',5'-tri-O-acetyl-b-D-ribofuranosyl)imidazo-4-carbonitrile**

NT11707

1mg	\$84.00
2mg	\$126.00
5mg	\$210.00



**5-Trimethylstannyl-1-(2-deoxy-2-fluoro-b-D-arabinofuranosyl)uracil**[213136-14-2] C<sub>12</sub>H<sub>19</sub>FN<sub>2</sub>O<sub>5</sub>S 408.98

NT08919

5mg	\$682.50
10mg	\$1050.00
25mg	\$1969.00

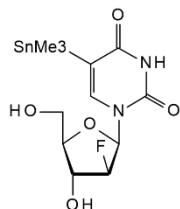

Refs: Vaidyanathan G, et.al, Nucl. Med. Biol, 1998, 25, p487

**5-(Trimethylstannyl)-2'-deoxyuridine**

• 2'-Deoxy-5-(trimethylstannyl)uridine

[146629-34-7] C<sub>12</sub>H<sub>20</sub>N<sub>2</sub>O<sub>5</sub>Sn 391.01

NT16878

10mg	\$139.80
25mg	\$254.50
50mg	\$462.00

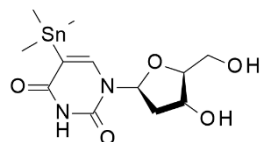

Refs: Bohman, C, et al, J. Biol. Chem, 269, 8036 (1994)

**2'/3'-O-Trinitrophenyl-adenosine-5'-diphosphate triethylammonium salt**

• TNP-ADP

[77450-67-0 (monoanion)][84430-17-1 (monosodium salt)]

C<sub>16</sub>H<sub>18</sub>N<sub>8</sub>O<sub>16</sub>P<sub>2</sub> 638.29  
Price On Application

NT29596

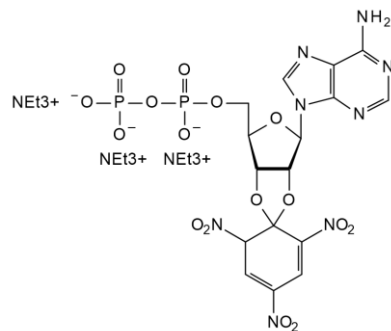
**2',3'-O-Trinitrophenyl-adenosine-5'-monophosphate triethylammonium salt**

• TNP-AMP

[807261-75-2 (free acid)] C<sub>16</sub>H<sub>15</sub>N<sub>8</sub>O<sub>13</sub>P 558.31

NT29595

1mg	\$250.00
2mg	\$400.00
5mg	\$625.00

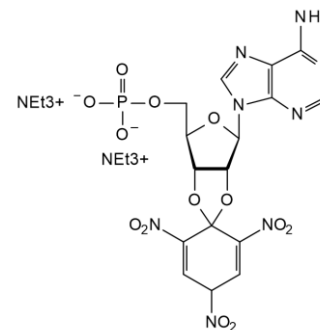
**2'/3'-O-Trinitrophenyl-adenosine-5'-triphosphate triethylammonium salt - 10mM aqueous solution**[61368-63-6 (pentaanion)][120360-48-7] C<sub>16</sub>H<sub>17</sub>N<sub>8</sub>O<sub>19</sub>P<sub>3</sub> 718.27

NT29597

5mg	\$498.80
10mg	\$945.00
25mg	\$1837.50

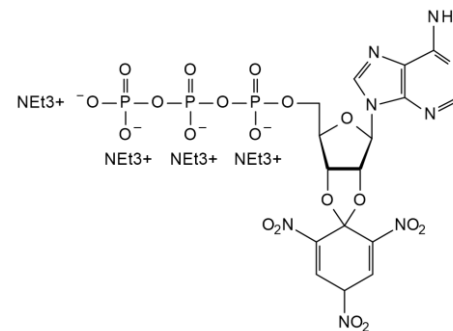
**Triphosphopyridine nucleotide potassium salt**see *b-Nicotinamide adenine dinucleotide phosphate potassium salt hydrate, NN11481* on page 331**α-Triphosphopyridine nucleotide**see *α-Nicotinamide adenine dinucleotide phosphate, NN29116* on page 332

**Tritylanhydr****5'-O-Trityl-2,3'-anhydrothymidine**[25442-42-6] C<sub>29</sub>H<sub>28</sub>N<sub>2</sub>O<sub>4</sub> 466.53

NT09993

500mg	\$95.00
1g	\$157.50
2g	\$262.50

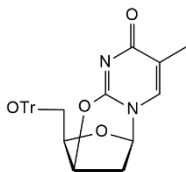
**5'-O-Trityl-3'-b-hydroxythymidine**[55612-11-8] C<sub>29</sub>H<sub>28</sub>N<sub>2</sub>O<sub>6</sub> 500.54

NT06346

25mg	\$89.50
50mg	\$168.00
100mg	\$263.00

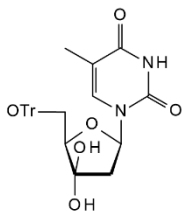
**5'-O-Trityl-D3-thymidine**C<sub>29</sub>H<sub>25</sub>N<sub>2</sub>O<sub>5</sub>D<sub>3</sub> 487.56

NT08920

Price On Application

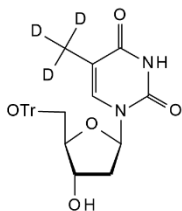
**5'-O-Tritylthymidine**[7791-71-1] C<sub>29</sub>H<sub>28</sub>N<sub>2</sub>O<sub>5</sub> 484.54

NT08062

500mg	\$145.00
1g	\$210.00
2g	\$392.70

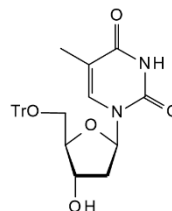
**5'-O-Trityluridine**[6554-10-5] C<sub>28</sub>H<sub>26</sub>N<sub>2</sub>O<sub>6</sub> 486.52

NT06665

250mg	\$92.50
500mg	\$160.00
1g	\$273.00

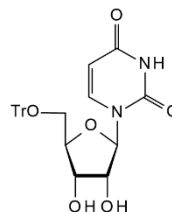

Refs: Roussev CD, Ivanova GD, Bratovanova EK, Petkov DD, Angew. Chem. Int. Ed. Vol39, Pt4, p779-781

**Troxacitabine**

• 4-Amino-1-((2S,4S)-2-(hydroxymethyl)-1,3-dioxolan-4-yl)pyrimidin-2(1H)-one

[145918-75-8] C<sub>8</sub>H<sub>11</sub>N<sub>3</sub>O<sub>4</sub> 213.19

NT29825

10mg	\$2500.00
25mg	\$3375.00
50mg	\$4950.00

**5'-O-Trt-2'-deoxyuridine**

see 2'-Deoxy-5'-O-trityluridine, NT08746 on page 223

**TTP**

see Thymidine-5'-triphosphate trisodium salt, NT05748 on page 365

**Tubercidin**

see 7-Deazaadenosine, ND06290 on page 164

**UDP-N-azidoacetylglactosamine**

• UDP-GalNAz

C<sub>17</sub>H<sub>24</sub>N<sub>6</sub>O<sub>17</sub>P<sub>2</sub>·2Na 692.33

NU30954

1mg	\$2000.00
2mg	\$3000.00
5mg	\$5500.00

**UDP-N-azidoacetylglucosamine**

• UDP-GlcNAz

NU30953

Price On Application

**UDP-GalNAz**

see UDP-N-azidoacetylglactosamine, NU30954 on page 379

**UDP-GlcNAz**

see UDP-N-azidoacetylglucosamine, NU30953 on page 379

**UDP.2Na**

see Uridine 5'-diphosphate disodium salt, NU03399 on page 380

**UK 088800**

see 5-(2-Ethoxyphenyl)-1-methyl-3-n-propyl-1,6-dihydro-7H-pyrazolo[4,3-d]pyrimidin-7-one, NE16544 on page 270

**UMP Disodium salt**

see Uridine 5'-monophosphate disodium salt, NU02983 on page 380

**3'-UMP Na2**

see Uridine 3'-monophosphate disodium salt, NU07383 on page 380

**5'-UMP Na2**

see Uridine 5'-monophosphate disodium salt, NU02983 on page 380

**UMP**

see Uridine 5'-monophosphate, NU05691 on page 381

**UpU**

see Zeatin riboside, NZ08027 on page 385

**Uracil 1-b-D-arabinofuranoside**

see 1-(b-D-Arabinofuranosyl)uracil, NA05962 on page 75

**Uracil arabinonucleoside 5'-phosphate**

see 1-b-D-Arabinofuranosyluracil 5'-monophosphate, NA16509 on page 75

**Uracil-1-b-D-ribofuranoside**

see Uridine, NU06309 on page 382

**Uracil Sodium salt**

[42563-71-3]

NU05635

Price On Application

**Uridine-6-carboxylic acid**

see Orotidine, NO08048 on page 338

**Uridine cyclic 2',3'-(hydrogen phosphate) monosodium salt**

see Uridine-2',3'-cyclic monophosphate sodium salt, NU16888 on page 380

## Uridinecycli

## Uridine-2',3'-cyclic monophosphate sodium salt

• Uridine cyclic 2',3'-(hydrogen phosphate) monosodium salt

[15718-50-0] C<sub>9</sub>H<sub>10</sub>N<sub>2</sub>NaO<sub>8</sub>P 328.15

NU16888	5mg	\$75.00
	10mg	\$120.00
	25mg	\$250.00

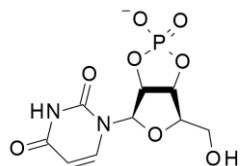
Na<sup>+</sup>

Refs: Tomasz, J, et al, Nucleic Acid Chem, 2, 875 (1978)

## Uridine-3',5'-cyclic monophosphate sodium salt

[56632-58-7] C<sub>9</sub>H<sub>10</sub>N<sub>2</sub>O<sub>8</sub>P·Na 328.2

NU12797	10mg	\$150.00
	25mg	\$350.00
	50mg	\$650.00



## Uridine 5'-diphosphate choline ammonium salt

• Uridine 5'-(trihydrogen diphosphate) P<sup>-</sup>-[2-(trimethylammonio)ethyl] ester inner salt[99492-83-8] C<sub>14</sub>H<sub>28</sub>N<sub>4</sub>O<sub>12</sub>P<sub>2</sub> 506.34

NU16887	1mg	\$125.00
	2mg	\$190.00
	5mg	\$375.00

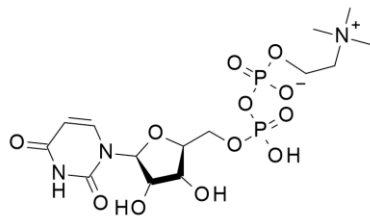

Refs: Kennedy, E.P, et al, J. Biol. Chem, 222, 185 (1956)

## Uridine 5'-diphosphate disodium salt

• UDP.2Na

[21931-53-3][27821-45-0] C<sub>9</sub>H<sub>12</sub>N<sub>2</sub>O<sub>12</sub>P<sub>2</sub>Na<sub>2</sub> 448.12

NU03399	1g	\$65.00
	2g	\$105.00
	5g	\$195.00

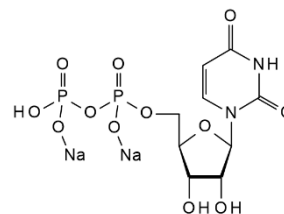

## Uridine 3'-monophosphate disodium salt

• Uridylic acid disodium salt  
• 3'-UMP Na<sub>2</sub>[35170-03-7] C<sub>9</sub>H<sub>11</sub>N<sub>2</sub>Na<sub>2</sub>O<sub>9</sub>P 368.15

NU07383	50mg	\$68.50
	100mg	\$100.00
	250mg	\$157.50

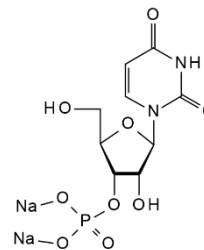

## Uridine 5'-monophosphate disodium salt

• UMP Disodium salt  
• 5'-UMP Na<sub>2</sub>[3387-36-8] C<sub>9</sub>H<sub>11</sub>N<sub>2</sub>Na<sub>2</sub>O<sub>9</sub>P 368.15

NU02983	50g	\$45.00
	100g	\$75.00
	250g	\$150.00

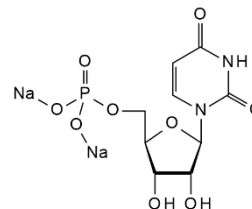



**Uridine 5'-monophosphate**

- UMP
- Uridylic acid

[58-97-9] C<sub>9</sub>H<sub>13</sub>N<sub>2</sub>O<sub>9</sub>P 324.18

NU05691

250mg	\$60.00
500mg	\$90.00
1g	\$150.00

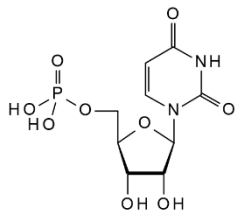
**Uridine 5'-triphosphate disodium salt**[285978-18-9] C<sub>9</sub>H<sub>13</sub>N<sub>2</sub>O<sub>15</sub>P<sub>3</sub>·2Na 528.11

NU10275

5g	\$65.00
10g	\$115.00
25g	\$184.00

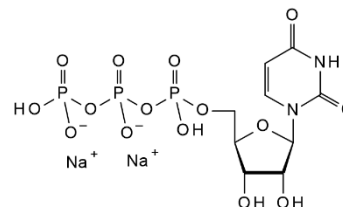
**Uridine 5'-triphosphate trisodium salt**

- UTP

[19817-92-6][285978-18-9] C<sub>9</sub>H<sub>12</sub>N<sub>2</sub>O<sub>15</sub>P<sub>3</sub>·3Na 550.09

NU03863

5g	\$65.00
10g	\$120.00
25g	\$175.00

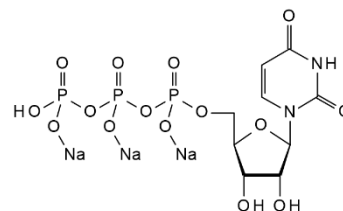
**Uridine 5'-triphosphate**

- 5'-UTP

[63-39-8]

NU04388

Price On Application

**Uridine 5'-(pentahydrogen tetraphosphate), P<sup>5</sup>-ester 2'-deoxycytidine**see 2'-Deoxycytidine P<sup>5</sup>-5'-ester with uridine 5'-(pentahydrogen tetraphosphate) sodium salt, ND45968 on page 175**Uridine 5'-O-(1-thiotriphosphate) lithium salt - 100mM aqueous solution**

- a-Thio-UTP

[71214-29-4] C<sub>9</sub>H<sub>15</sub>N<sub>2</sub>O<sub>14</sub>P<sub>3</sub>S 500.21

NU58208

0.5ug	\$45.00
1ug	\$80.00
2ug	\$145.00

**Uridine 2',3',5'-triacetate**

see 2',3',5'-Tri-O-acetyluridine, NT06907 on page 372

**Uridine 5'-(trihydrogen diphosphate) P<sup>1</sup>-[2-(trimethylammonio)ethyl] ester inner salt**

see Uridine 5'-diphosphate choline ammonium salt, NU16887 on page 380

**Uridine 5'-triphosphate dihydrate trisodium salt**[116295-90-0] C<sub>9</sub>H<sub>12</sub>N<sub>2</sub>O<sub>15</sub>P<sub>3</sub>Na<sub>3</sub> 550.09

NU35409

1g	\$75.00
2g	\$120.00
5g	\$175.00



## Uridine

## L-Uridine

• 1-(b-L-ribofuranosyl)uracil

[26287-69-4] C<sub>9</sub>H<sub>12</sub>N<sub>2</sub>O<sub>6</sub> 244.2

NU04051	5mg	\$63.00
	10mg	\$105.00
	25mg	\$189.00

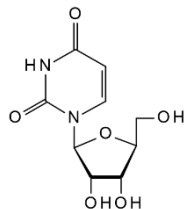

Refs: Jurovcik M, Holý A, Nucleic Acids Res. 1976, Aug, 3(8), 2143–2154



## Uridine

• Uracil-1-b-D-ribofuranoside

[58-96-8] C<sub>9</sub>H<sub>12</sub>N<sub>2</sub>O<sub>6</sub> 244.2

NU06309	100g	\$50.00
	250g	\$90.00
	500g	\$150.00

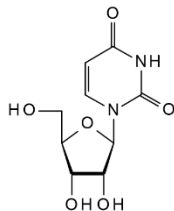

Refs: Loring HS, Ploeser JMT, J. Biol. Chem. 1949, p439



## Uridylic acid disodium salt

see Uridine 3'-monophosphate disodium salt, NU07383 on page 380

## Uridylic acid

see Uridine 5'-monophosphate, NU05691 on page 381

## Uridyl-3'-5'-adenosine ammonium salt

C<sub>19</sub>H<sub>27</sub>N<sub>6</sub>O<sub>12</sub>P 590.44

NU46047	1mg	\$475.00
	2mg	\$925.00
	5mg	\$1625.00



## Uridyl-3'-5'-cytidine ammonium salt

C<sub>18</sub>H<sub>27</sub>N<sub>6</sub>O<sub>13</sub>P 566.41

NU46048	1mg	\$475.00
	2mg	\$925.00
	5mg	\$1625.00



## Uridyl-3'-5'-guanosine ammonium salt

C<sub>19</sub>H<sub>24</sub>N<sub>7</sub>O<sub>13</sub>P 589.41

NU46049	1mg	\$475.00
	2mg	\$925.00
	5mg	\$1625.00



## Uridyl-2'-5'-uridine ammonium salt

[108321-54-6] C<sub>18</sub>H<sub>23</sub>N<sub>4</sub>O<sub>14</sub>P·NH<sub>3</sub> 567.41

NU07988	1mg	\$89.30
	2mg	\$168.00
	5mg	\$315.00

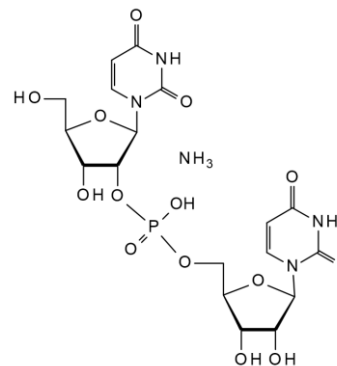

## 5'-UTP

see Uridine 5'-triphosphate, NU04388 on page 381

## UTP

see Uridine 5'-triphosphate trisodium salt, NU03863 on page 381

**[U-13C10, U-15N2]-Labelled thymidine**

NL32196

Price On Application

**U-13C10, U-[15N2]-Labelled Thymidylyl-3'-5'-thymidine ammonium**C<sub>20</sub>H<sub>30</sub>N<sub>5</sub>O<sub>12</sub>P 563.45

NL31906

2mg

\$3400.00

**506u**see *Nelarabine*, NN26176 on page 331**Valtorcitabine**see *2'-Deoxy-L-cytidine 3'-O-L-valinyl ester 2HCl*, ND10527 on page 176**Vengicide**see *Toyocamycin*, NT44985 on page 369**Vidarabine monophosphate**see *9-(b-D-Arabinofuranosyl)adenine 5'-monophosphate*, NA09216 on page 72**Vidarabine 5'-triphosphate sodium salt**see *9-(b-D-Arabinofuranosyl)adenine 5'-triphosphate triethyammonium salt*, NA15330 on page 72**Vidarabine**see *9-(b-D-Arabinofuranosyl)adenine*, NA06007 on page 72**Vidaza**see *5-Azacytidine*, NA02947 on page 76**Viramid**see *Ribavirin*, NR02712 on page 350**Virazole 5'-monophosphate**see *Ribavirin 5'-monophosphate diammonium salt*, NR46023 on page 349**WRC 0013**see *2-(2-Cyclohexylethoxy)adenosine*, NC16523 on page 157**WRC 0018**see *2-[2-(2-Naphthalenyl)ethoxy]adenosine*, NN16559 on page 330**Wybutosine**see *(S)-4,9-Dihydro-a-[(methoxycarbonyl)amino]-4,6-dimethyl-9-oxo-3-b-D-ribofuranosyl-3H-Imidazo[1,2-a]purine-7-butanolic acid methyl ester*, ND157877 on page 247**2269W**see *Abacavir carboxylate*, NA16897 on page 9**Xanthosine dihydrate**

• 9-b-D-Ribofuranosylxanthine

[5968-90-1] C<sub>10</sub>H<sub>12</sub>N<sub>4</sub>O<sub>6</sub>·2H<sub>2</sub>O 320.26

NX28984

2g	\$50.00
5g	\$95.00
10g	\$160.00

**Xanthosine-5'-monophosphate ammonium salt**

NX31145

Price On Application



**Xanthosinemo****Xanthosine 5'-monophosphate disodium salt**

• 5'-Xanthylic acid, disodium salt

[25899-70-1]	C <sub>10</sub> H <sub>11</sub> N <sub>4</sub> Na <sub>2</sub> O <sub>9</sub> P	408.17		
NX09700			25mg	\$65.00
			50mg	\$110.00
			100mg	\$195.00

**Xanthosine 5'-triphosphate disodium salt**[105931-36-0] C<sub>10</sub>H<sub>13</sub>N<sub>4</sub>O<sub>15</sub>P<sub>3</sub>·2Na 568.13

NX65210			1mg	\$110.00
			2mg	\$190.00
			5mg	\$390.00

**Xanthosine-5'-triphosphate triethylammonium salt - 100 mM aqueous solution**

• XTP

[6253-56-1]	C <sub>10</sub> H <sub>15</sub> N <sub>4</sub> O <sub>15</sub> P <sub>3</sub>	524.17 (free acid)		
NX143915			0.8mg	\$200.00
			4mg	\$600.00

**Xanthosine**

• 9-b-D-Ribofuranosylxanthine

[146-80-5]	C <sub>10</sub> H <sub>12</sub> N <sub>4</sub> O <sub>8</sub>	284.23		
NX02884			2g	\$60.00
			5g	\$100.00
			10g	\$175.00

**5'-Xanthylic acid, disodium salt**see *Xanthosine 5'-monophosphate disodium salt, NX09700 on page 384***XTP**see *Xanthosine-5'-triphosphate triethylammonium salt - 100 mM aqueous solution, NX143915 on page 384***Zalcitabine triphosphate lithium salt**see *2',3'-Dideoxycytidine-5'-triphosphate lithium salt - 100mM aqueous solution, ND32066 on page 240***Zalcitabine triphosphate trisodium salt**see *2',3'-Dideoxycytidine-5'-triphosphate trisodium salt, ND10280 on page 240***Zalcitabine**see *2',3'-Dideoxycytidine, ND06559 on page 240***cis-Zeatin-o-glucoside riboside**

• 6-((Z)-4-b-D-glucopyranosyloxy-3-methylbut-2-enylamino)-9-b-D-ribofuranosylpurine

[125225-72-1]	C <sub>21</sub> H <sub>31</sub> N <sub>5</sub> O <sub>10</sub>	513.5		
NZ30353			1mg	\$450.00
			2mg	\$790.00
			5mg	\$1475.00

**trans-Zeatin-o-glucoside riboside**

• 6-((E)-4-b-D-glucopyranosyloxy-3-methylbut-2-enylamino)-9-b-D-ribofuranosylpurine

[62512-97-4]	C <sub>21</sub> H <sub>31</sub> N <sub>5</sub> O <sub>10</sub>	513.5		
NZ30326			1mg	\$500.00
			2mg	\$900.00
			5mg	\$2000.00

**Zeatin ribonucleotide**see *trans-Zeatin riboside-5'-monophosphate sodium salt, NZ30328 on page 385*

X

**trans-Zeatin riboside-5'-monophosphate sodium salt**

- 6-((E)-4-hydroxy-3-methylbut-2-enylamino)-9-b-D-ribofuranosyl-purine-5'-monophosphate disodium monohydrate
- Zeatin ribonucleotide

[25615-16-1] C<sub>15</sub>H<sub>20</sub>N<sub>5</sub>O<sub>8</sub>PNa<sub>2</sub>·H<sub>2</sub>O 493.32

NZ30328	1mg	\$480.00
	2mg	\$800.00
	5mg	\$1400.00

**trans-Zeatin riboside**

- 6-((E)-4-hydroxy-3-methylbut-2-enylamino)-9-b-D-ribofuranosylpurine

[6025-53-2] C<sub>15</sub>H<sub>21</sub>N<sub>5</sub>O<sub>5</sub> 351.36

NZ30302	10mg	\$65.00
	25mg	\$95.00
	50mg	\$125.00

**Zeatin riboside**

- UpU
- N6-(4-Hydroxy-3-methylbut-2-enyl)adenosine

[28542-78-1] C<sub>15</sub>H<sub>21</sub>N<sub>5</sub>O<sub>5</sub> 351.36

NZ08027	2mg	\$42.00
	5mg	\$68.30
	10mg	\$99.80

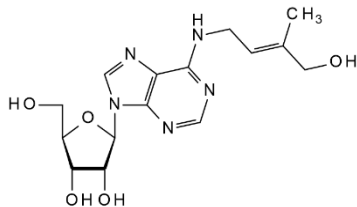
**Zebularine**

see 4-Deoxyuridine, ND09503 on page 225

**Zidovudine Impurity 2**

see 3'-Azido-3'-deoxy-5'-O-tritylthymidine, NA10412 on page 88

**Zidovudine 5'-monophosphate sodium salt**

see 3'-Azido-3'-deoxythymidine 5'-monophosphate sodium salt, NA06326 on page 87

**Zidovudine Related Compound A**

see 2',3'-Didehydro-2',3'-dideoxythymidine, ND07118 on page 239

**Zidovudine 5'-triphosphate triethylammonium salt**

see 3'-Azido-3'-deoxythymidine 5'-triphosphate triethylammonium salt, NA15338 on page 88

**Zidovudine**

see 3'-Azido-3'-deoxythymidine, NA05636 on page 88

**6-(Trifluoromethyl)-2,4-pyrimidinediol**

see 6-(Trifluoromethyl)uracil, ND57450 on page 376

**3'-Azido-3'-deoxycytidine**[70580-87-9] C<sub>8</sub>H<sub>12</sub>N<sub>6</sub>O<sub>4</sub> 268.23

NA144615	1mg	\$112.50
	2mg	\$171.00
	5mg	\$337.50

**5'-O-DMT-N2-isobutyryl-2'-O-propargylguanosine**

[171486-53-6]

ND157230

Price On Application



Z

# Carbosynth



## Human Milk Oligosaccharides

Human breast milk provides the primary source of nutrition for newborns before they are able to eat and digest other foods. One distinctive property of human milk from most other species is the amount and diversity of the free oligosaccharide it contains. These human milk oligosaccharides (HMO) can be present at levels of up to 12 g/l in milk and up to 20 g/l in colostrum.<sup>1</sup> HMO have been attributed with a variety of functions including:

- 1) Prebiotic
- 2) Decoy carbohydrate
- 3) Immunomodulation

### HMO Structure

Currently at least 130 unique HMO have been identified, all differing by constituent sugars, molecular weight or structure. Many share a common motif characterized by repetitive attachment of galactose (Gal) and N-acetylglucosamine (GlcNAc)<sup>2</sup> in a  $\beta$ -glycosidic linkage to lactose. Additional variety is generated by the addition of fucose (termed neutral HMO), e.g. 3'-Fucosyllactose, (OF05673) or 2-Fucosyllactose, (OF06739) and sialic acid (termed acidic HMO), e.g. 6'-Sialyllactose, (OS04398) and 3'-Sialyllactose, (OS04397). Addition is via  $\alpha$ -glucosidic bonds to generate oligosaccharides from three to thirty two sugars in length. Whilst most of the biosynthesis of HMO is not controlled at the gene level (unlike proteins) the presence and position of fucosylation is governed by the Lewis/Secretor status of the mother.<sup>3</sup> Dominant neutral oligosaccharides have been identified as lacto-N-tetraose (OL05683), lacto-N-neotetraose (OL05765) and lacto-N-fucopentaose I and V (OL05676 and OL06817 respectively)<sup>4</sup>

### Prebiotic Properties of HMO

The most abundant HMO is lacto-N-tetraose which is able to survive the acid environment of the stomach and is not degraded by normal gut enzymes. It therefore can pass down to the lower intestine where it acts as a prebiotic which encourages lower gut colonisation by many bifidobacteria species, which are recognised as essential for normal gut function.<sup>5</sup>

### HMO as Decoy Carbohydrates

Binding to a host cell wall is critical for the virulence of many pathogenic bacteria including *Campylobacter jejuni*, *E.coli*, *Vibrio cholera*, and *Shigella* and some *Salmonella* strains. Many of the virulence factors of these organisms are carbohydrate-binding proteins (lectins) which bind sugars displayed on cell membranes. HMO can bind to these lectins acting as decoys and preventing pathogens from

sticking to the target cells. An example of this is the inverse relationship between the incidence of *C. jejuni*, (one of the most predominant causes of diarrhoea in the world) in breast-fed children and levels of 2-fucosyl-lactose in the mother's milk. (*C. jejuni* is known to adhere to intestinal 2-fucosyl-lactosamine).<sup>6</sup> Similar antimicrobial effects of HMO have also been demonstrated for calicivirus diarrhoea and infections with heat stable enterotoxin of *E. coli*.<sup>7</sup>

During ingestion, HMO coat the throat and are known to inhibit adhesion of *Streptococcus pneumoniae* and *Haemophilus influenzae* to human pharyngeal or buccal epithelial cells resulting in the lower incidence of otitis media (inner ear infection) in breast fed babies.<sup>8</sup>

### Immune Role of HMO

Selectins are glycoproteins which are displayed on the surface of many cells of the immune system and are involved with cell/cell interactions such as the infiltration of tissues in inflammation. Selectins bind to specific fucosylated and sialylated oligosaccharides, e.g., sialyl Lewis x (sLe<sup>x</sup>, OS04058), on their respective target ligands. HMO share many structural similarities to these carbohydrate ligands and acidic (sialylated) HMO are able to inhibit rolling and adhesion of leucocytes at physiologically relevant concentrations.

One of these selectin interactions is the formation of platelet/neutrophil complexes (PNCs) which lead to the activation of the neutrophils. PNCs are thought to be involved in necrotizing enterocolitis (NEC) and HMO have been attributed as the agent responsible for the lower incidence of NEC in breast fed infants (85 % lower than formula fed infants) via inhibition of PNC formation.<sup>9</sup>

Fractions of HMO are also known to inhibit the binding of both Galectins which bind  $\beta$ -Gal and LacNAc terminated glycans and Siglecs which are specific for terminal sialic acid, their role in immunity or development however has not yet been fully explored.<sup>10,11</sup>

### References:

1. Coppa GV, et al. *Acta Paediatr.* 1999 Suppl 88, 89.
2. Boehm G, Stahl B. Oligosaccharides. Mattila-Sandholm T, editor. *Functional dairy products.* Cambridge Woodhead Publishers 2003, 203.
3. Thurl S, et al. *Glycoconj J.* 1997, 14, 795-9.
4. Ninonuevo M et al. *J Agric Food Chem.* 2008, 56, 618.
5. Kiyohara M, et al. *Bioscience, Biotechnology, and Biochemistry.* 2009, 73 (5) 1175.
6. Morrow al. *J Pediatr.* 2004, 145, 297.
7. Newburg DS, et al. *Adv Exp Med Biol.* 2004, 554, 457.
8. Andersson B, et al. *J Infect Dis.* 1986, 153, 232.
9. Bode L, et al. *Thromb Haemost.* 2004, 92, 1402.
10. Perillo N et al. *J Mol Med.* 1998, 76, 402.
11. Crocker PR. *Curr Opin Struct Biol.* (2002);12:609-15



# Formula Index

Formula	Product Name	Page
C <sub>8</sub> H <sub>8</sub> D <sub>2</sub> FN <sub>2</sub> <sup>15</sup> NO <sub>3</sub> S	Emtricitabine-d2, 15N	267
CaHBr <sub>3</sub> N <sub>2</sub>	2,4,6-Tribromopyrimidine	374
CaH <sub>2</sub> ClFN <sub>2</sub>	4-Chloro-5-fluoropyrimidine	146
CaH <sub>2</sub> ClFN <sub>2</sub> O	2-Chloro-4-hydroxy-5-fluoropyrimidine	146
C <sub>8</sub> H <sub>8</sub> N <sub>6</sub> OS	8-Aza-6-hydroxy-2-mercaptapurine	78
C <sub>8</sub> H <sub>8</sub> ClN <sub>3</sub>	4-Chloro-5-aminopyrimidine	140
CaH <sub>8</sub> N <sub>4</sub> Cl <sub>2</sub>	2,5-Diamino-4,6-dichloropyrimidine	231
CaH <sub>8</sub> N <sub>4</sub> O <sub>3</sub>	4-Amino-2,6-dihydroxy-5-nitrosopyrimidine	52
CaH <sub>8</sub> N <sub>4</sub> O	6-Azathymine	78
CaH <sub>8</sub> N <sub>4</sub> O <sub>2</sub>	2,4-Diamino-6-hydroxy-5-nitrosopyrimidine	231
CaH <sub>8</sub> N <sub>4</sub>	Pyrimidine-2-ylhydrazine	347
C <sub>8</sub> H <sub>8</sub> BN <sub>3</sub> O <sub>2</sub>	2-Aminopyrimidine-5-boronic acid	61
CaH <sub>8</sub> N <sub>4</sub> O <sub>2</sub>	5,6-Diaminouracil	232
CaH <sub>8</sub> N <sub>4</sub> O <sub>2</sub> S	2-Amino-5-pyrimidinesulfonamide	61
CaH <sub>7</sub> N <sub>5</sub> O <sub>2</sub> S	4-Amino-6-hydroxy-2-mercapto-5-nitrosopyrimidine ammonium salt	55
CaH <sub>10</sub> N <sub>2</sub> O <sub>3</sub>	Alloxan tetrahydrate	31
C <sub>8</sub> H <sub>8</sub> BrCl <sub>2</sub> N	4-Bromo-3,5-dichloropyridine	126
C <sub>8</sub> H <sub>2</sub> ClN <sub>3</sub>	2-Chloro-4-pyrimidinecarbonitrile	152
C <sub>8</sub> H <sub>3</sub> Cl <sub>3</sub> N <sub>2</sub>	2,4,6-Trichloro-5-methylpyrimidine	375
C <sub>8</sub> H <sub>3</sub> ClN <sub>4</sub>	2-Chloropurine	152
CaH <sub>3</sub> F <sub>3</sub> N <sub>2</sub> O <sub>2</sub>	6-(Trifluoromethyl)uracil	376
CaH <sub>8</sub> Cl <sub>2</sub> N <sub>2</sub> O	4,6-Dichloro-5-methoxypyrimidine	236
C <sub>8</sub> H <sub>8</sub> ClN <sub>3</sub> O	2-Chloropyrimidine-4-carboxamide	152
	4-Amino-6-chloropyrimidine-5-carbaldehyde	42
C <sub>8</sub> H <sub>8</sub> N <sub>3</sub> S	Pyrimidine-5-carbothioic acid amide	347
CaH <sub>8</sub> N <sub>4</sub> O	4-Amino-6-hydroxypyrazolo(3,4-D)pyrimidine	56
CaH <sub>8</sub> N <sub>4</sub> O	5-(Hydroxymethyl)pyrimidine	290
	4-Hydroxy-6-methylpyrimidine	290
C <sub>8</sub> H <sub>8</sub> ClN <sub>3</sub> O	2-Amino-6-chloro-4-methoxypyrimidine	41
C <sub>8</sub> H <sub>8</sub> N <sub>4</sub> O	Pyrimidine-4-carboxylic acid hydrazide	347
CaH <sub>7</sub> N <sub>3</sub>	2-Pyrimidinmethanamine	347
CaH <sub>8</sub> N <sub>4</sub> HCl	Pyrimidine-5-carboxamide hydrochloride	347
CaH <sub>7</sub> N <sub>4</sub> OS·H <sub>2</sub> O	2-Methylmercapto-4-oxo-6-aminopyrimidine monohydrate	320
CaH <sub>10</sub> FNO <sub>3</sub>	2-Deoxy-2-fluoro-b-D-arabinofuranosylamine	193
	2-Deoxy-2-Fluoro-a-D-arabinofuranosylamine	193
CaH <sub>2</sub> BrN <sub>3</sub> O <sub>2</sub>	5-Bromo-2-cyano-3-nitropyridine	123
CaH <sub>3</sub> BrFN <sub>2</sub> O	5-Bromo-2-fluoronicotinic acid	126
CaH <sub>4</sub> Cl <sub>2</sub> N <sub>4</sub>	2,6-Dichloro-7-methylpurine	236
CaH <sub>4</sub> N <sub>3</sub> O	3,7-Dihydro-5-iodo-4-oxo-4H-pyrrolo[2,3-d]pyrimidine	247
CaH <sub>8</sub> N <sub>4</sub> OS	4-Hydroxy-2-mercaptopteridine	289
CaH <sub>8</sub> ClNO <sub>2</sub>	2-Chloro-4-pyridinecarboxylic acid	152
	2-Chloroisonicotinic acid	148
CaH <sub>8</sub> N <sub>4</sub> O <sub>2</sub>	[1,2,4]Triazol[1,5-a]pyrimidine-2-carboxylic acid	373
CaH <sub>4</sub> F <sub>2</sub> N <sub>2</sub> O <sub>3</sub>	4-(difluoromethyl)-2-hydroxy-pyrimidine-5-carboxylic acid	247
CaH <sub>5</sub> N <sub>3</sub>	7H-Pyrrolo[2,3d]pyrimidine	348
	7-Deazapurine	170
CaH <sub>8</sub> ClN <sub>4</sub>	6-Chloro-9-methylpurine	149
CaH <sub>8</sub> N <sub>3</sub> OS	7-Deaza-2-mercaptohypoxanthine	169
CaH <sub>8</sub> N <sub>2</sub> O <sub>2</sub>	Pyrimidine-4-carboxylic acid methyl ester	347
	3-Methyl-2-nitropyridine	321
CaH <sub>8</sub> ClN <sub>3</sub>	4-Amino-5-chloro-2,6-dimethylpyrimidine	41
CaH <sub>8</sub> N <sub>4</sub> O <sub>2</sub>	2,4-Dihydroxy-5,6-dimethylpyrimidine	248
CaH <sub>8</sub> N <sub>3</sub> O <sub>2</sub>	4-Amino-2,6-dimethoxypyrimidine	52
CaH <sub>8</sub> ClN <sub>3</sub> S	2-Methylthio-6-chloropurine	324
C <sub>7</sub> H <sub>8</sub> N <sub>4</sub> O	Pyrazolo[1,5-a]pyrimidine-2-carboxylic acid	346
C <sub>7</sub> H <sub>8</sub> Cl <sub>2</sub> NO <sub>3</sub>	3,5-Dichloro-4-pyridone-1-acetic acid	237
C <sub>7</sub> H <sub>8</sub> ClNO <sub>2</sub>	5-Chloro-2-pyridinecarboxylic acid methyl ester	152
C <sub>7</sub> H <sub>7</sub> ClN <sub>2</sub> O <sub>2</sub>	Methyl 2-chloro-6-methylpyrimidine-4-carboxylate	313
C <sub>7</sub> H <sub>8</sub> N <sub>2</sub> OS	2-(Ethylthio)pyrimidine-5-carbaldehyde	272
C <sub>7</sub> H <sub>8</sub> N <sub>4</sub> O <sub>2</sub>	2-(Methoxymethyl)-5-pyrimidinecarbaldehyde	307
C <sub>7</sub> H <sub>8</sub> N <sub>2</sub> O <sub>2</sub> S	4-Methyl-2-(methylsulfonyl)-5-pyrimidinecarboxylic acid	321
CaH <sub>7</sub> N <sub>3</sub> ·C <sub>2</sub> H <sub>2</sub> O <sub>4</sub>	2-(Aminomethyl)pyrimidine oxalate	59
C <sub>7</sub> H <sub>10</sub> N <sub>2</sub> O <sub>2</sub>	4-(Dimethoxymethyl)pyrimidine	249
C <sub>7</sub> H <sub>10</sub> N <sub>4</sub> O	Ethyl-2,4-diamino-pyrimidine-5-carboxylate	271
C <sub>7</sub> H <sub>15</sub> N <sub>2</sub> O <sub>8</sub> P	Glycinamide ribonucleotide	282
CaH <sub>8</sub> N <sub>2</sub> S <sub>2</sub>	4-(2-Thienyl)-2-pyrimidinethiol	358
C <sub>7</sub> H <sub>7</sub> ClN <sub>4</sub> S	2-Methylthio-6-chloro-9-methylpurine	324

Formula	Product Name	Page
C <sub>8</sub> H <sub>6</sub> F <sub>3</sub> N <sub>3</sub> O <sub>2</sub>	Ethyl 2-amino-4-(trifluoromethyl)pyrimidine-5-carboxylate	270
CaH <sub>6</sub> ClN <sub>2</sub> O <sub>2</sub>	Ethyl 2-chloro-4-methylpyrimidine-5-carboxylate	271
C <sub>8</sub> H <sub>8</sub> N <sub>4</sub> O <sub>3</sub> S	rac-Lamivudine acid	301
	Lamivudine acid	301
C <sub>8</sub> H <sub>10</sub> N <sub>6</sub>	2,4-Diamino-6,7-dimethylpteridine	231
CaH <sub>10</sub> N <sub>2</sub> O	2-Isopropyl-4-pyrimidinecarbaldehyde	300
CaH <sub>10</sub> N <sub>2</sub> O <sub>2</sub>	2-(2-Methoxyethyl)pyrimidine-5-carbaldehyde	307
CaH <sub>10</sub> FN <sub>3</sub> O <sub>3</sub> S	(+)-Emtricitabine	267
	Coviracil	155
CaH <sub>10</sub> N <sub>2</sub> O <sub>5</sub>	(2S,4S)-1[2-hydroxymethyl-1,3-dioxolan-4-yl]uracil	290
CaH <sub>10</sub> FN <sub>3</sub> O <sub>5</sub>	1-(5'-Deoxy-5'-fluoro-b-D-arabinofuranosyl)-2-nitroimidazole	194
CaH <sub>11</sub> N <sub>3</sub> O <sub>3</sub> S	Lamivudine	302
	5'-Epi lamivudine	269
	2'-Epi-lamivudine	268
	ent-Lamivudine	268
CaH <sub>11</sub> N <sub>3</sub> O <sub>4</sub>	Troxacitabine	378
CaH <sub>11</sub> N <sub>3</sub> O <sub>5</sub> S	6-Aza-2-thiouridine	78
CaH <sub>11</sub> N <sub>3</sub> O <sub>6</sub>	6-Azauridine	79
CaH <sub>11</sub> N <sub>3</sub> O <sub>6</sub> PSNa	Lamivudine 5'-monophosphate sodium salt	302
CaH <sub>12</sub> N <sub>4</sub> O <sub>4</sub>	5-Aza-2'-deoxycytidine	78
CaH <sub>12</sub> N <sub>4</sub> O <sub>5</sub>	a-Ribavirin (impurity B)	349
	Ribavirin	350
	Isonbavirin	300
	6-Azacytidine	76
	5-Azacytidine	76
CaH <sub>12</sub> N <sub>3</sub> O <sub>9</sub> P	6-Azauridine-5'-monophosphate	78
CaH <sub>12</sub> N <sub>4</sub> O <sub>11</sub> P <sub>2</sub> Li <sub>2</sub>	Ribavirin 5'-diphosphate lithium salt	348
CaH <sub>12</sub> N <sub>4</sub> O <sub>14</sub> P <sub>3</sub>	1,2,3-Triazole-4-carboxamide, 5-b-D-ribofuranosyl-5'-triphosphate-nucleoside triethyl ammonium salt	373
CaH <sub>12</sub> N <sub>4</sub> Na <sub>4</sub> O <sub>14</sub> P <sub>3</sub>	Ribavirin 5'-triphosphate sodium salt	349
CaH <sub>11</sub> Li <sub>2</sub> N <sub>4</sub> O <sub>9</sub> P	Ribavirin 5'-monophosphate dilithium salt	349
CaH <sub>13</sub> N <sub>4</sub> O <sub>9</sub> P	5-Azacytidine 5'-monophosphate	76
CaH <sub>13</sub> N <sub>4</sub> O <sub>9</sub> P·xNa	Ribavirin 5'-monophosphate sodium salt	349
CaH <sub>14</sub> N <sub>4</sub> O <sub>14</sub> P <sub>3</sub> ·Na	Ribavirin 5'-triphosphate triethylammonium salt - 10 mM aqueous solution	349
C <sub>9</sub> H <sub>15</sub> N <sub>4</sub> O <sub>6</sub> PS	Lamivudine 5'-monophosphate ammonium salt	302
CaH <sub>15</sub> N <sub>4</sub> O <sub>14</sub> P <sub>3</sub>	5-Azacytidine 5'-triphosphate	76
CaH <sub>15</sub> N <sub>4</sub> O <sub>14</sub> P <sub>3</sub> ·Na <sub>4</sub>	Ribavirin 5'-triphosphate tetrasodium salt - 10mM aqueous solution	349
CaH <sub>19</sub> N <sub>6</sub> O <sub>8</sub> P	Ribavirin 5'-monophosphate diammonium salt	349
CaH <sub>19</sub> N <sub>6</sub> O <sub>9</sub> P <sub>2</sub> S	Lamivudine 5'-diphosphate ammonium salt	301
CaH <sub>6</sub> N <sub>2</sub> OS	2-(2-Thienyl)-5-pyrimidinecarbaldehyde	358
CaH <sub>6</sub> N <sub>2</sub> O <sub>2</sub>	2-(2-Furyl)-5-pyrimidinecarbaldehyde	281
C <sub>9</sub> H <sub>10</sub> FN <sub>3</sub> O <sub>3</sub>	5-Fluoro-1-(2',3'-dideoxy-2',3'-didehydro-b-D-arabinofuranosyl)-cytosine	278
C <sub>9</sub> H <sub>10</sub> N <sub>2</sub> O <sub>4</sub>	2',3'-Didehydro-2',3'-dideoxyuridine	239
CaH <sub>10</sub> ClFN <sub>2</sub> O <sub>4</sub>	5-Chloro-2',3'-dideoxy-3'-fluorouridine	145
CaH <sub>10</sub> FIN <sub>2</sub> O <sub>4</sub>	2',5'-Dideoxy-2'-fluoro-5'-iodouridine	242
CaH <sub>10</sub> N <sub>2</sub> O <sub>5</sub>	3'-deoxy-3',4'-didehydrouridine	178
	2,2'-Anhydrouridine	69
	2,2'-Anhydro-L-uridine	69
CaH <sub>10</sub> F <sub>2</sub> N <sub>2</sub> O <sub>5</sub>	2'-Deoxy-2',2'-difluoro-a-uridine	179
	2,5'-Anhydro-5,6-didehydro-2'-deoxy-2',2'-difluorouridine	67
CaH <sub>10</sub> FIN <sub>2</sub> O <sub>5</sub>	Fialuridine (Firu)	274
	2'-Deoxy-2'-fluoro-5-iodouridine	198
C <sub>9</sub> H <sub>10</sub> FN <sub>3</sub> O <sub>5</sub>	1-(2'-Deoxy-2'-fluoro-b-D-arabinofuranosyl)-5-iodouracil	194
	4'-C-Azido-3'-deoxy-3'-fluorouridine	85
	4'-C-Azido-2'-deoxy-2'-fluoro-b-D-arabinouridine	85
C <sub>9</sub> H <sub>10</sub> FIN <sub>2</sub> O <sub>6</sub>	5-Fluoro-6-iodouridine	278
CaH <sub>10</sub> N <sub>2</sub> O <sub>8</sub> P·Na	Uridine-3',5'-cyclic monophosphate sodium salt	380
CaH <sub>10</sub> Na <sub>2</sub> NaO <sub>8</sub> P	Uridine-2',3'-cyclic monophosphate sodium salt	380
C <sub>9</sub> H <sub>10</sub> FN <sub>3</sub> O <sub>8</sub> P·2Na	2'-Deoxy-5-fluorouridine 5'-monophosphate sodium salt	203
C <sub>9</sub> H <sub>10</sub> N <sub>2</sub> O <sub>14</sub> P <sub>3</sub> ·4Na	2'-Deoxy-5-iodouridine-5'-triphosphate sodium salt - 10mM aqueous solution	210
CaH <sub>10</sub> FN <sub>2</sub> O <sub>14</sub> P <sub>3</sub> ·4Na	2'-Deoxy-5-fluorouridine-5'-triphosphate sodium salt	203



# Formula Index

C<sub>9</sub>H<sub>13</sub>N<sub>5</sub>O<sub>5</sub>

Formula	Product Name	Page
C <sub>9</sub> H <sub>11</sub> N <sub>3</sub> O <sub>2</sub> S	4-(Cyclopropylamino)-2-(Methylthio)Pyrimidine-5-Carboxylic Acid	158
C <sub>9</sub> H <sub>11</sub> FN <sub>2</sub> O <sub>4</sub>	2',3'-Dideoxy-3'-fluorouridine	243
	2',3'-Dideoxy-3'-fluoro-a-uridine	243
	2',3'-Dideoxy-2'-fluorouridine	243
C <sub>9</sub> H <sub>11</sub> IN <sub>2</sub> O <sub>4</sub>	2',3'-Dideoxy-5-iodouridine	245
C <sub>9</sub> H <sub>11</sub> N <sub>3</sub> O <sub>4</sub>	2,2'-Anhydrocytidine	67
C <sub>9</sub> H <sub>11</sub> F <sub>2</sub> N <sub>3</sub> O <sub>4</sub>	3'-Epi gemcitabine	268
	2'-Deoxy-2',2'-difluorocytidine	178
C <sub>9</sub> H <sub>11</sub> N <sub>5</sub> O <sub>4</sub>	3'-Azido-2',3'-dideoxyuridine	91
C <sub>9</sub> H <sub>11</sub> FN <sub>6</sub> O <sub>4</sub>	4'-C-Azido-3'-deoxy-3'-fluorocytidine	85
	4'-C-Azido-2'-deoxy-2'-fluoro-b-D-arabinocytidine	85
C <sub>9</sub> H <sub>11</sub> BrN <sub>2</sub> O <sub>5</sub>	5-Bromo-2'-deoxyuridine	126
	2'-Bromo-2'-deoxyuridine	125
C <sub>9</sub> H <sub>11</sub> ClN <sub>2</sub> O <sub>5</sub>	3'-epi-5-chloro-2'-deoxyuridine	268
	5-Chloro-5'-deoxyuridine	145
	5-Chloro-2'-deoxyuridine	145
	2'-Chloro-2'-deoxyuridine	145
C <sub>9</sub> H <sub>11</sub> FN <sub>2</sub> O <sub>5</sub>	3'-Fluoro-3'-deoxyuridine	277
	5'-Deoxy-5-fluorouridine	204
	2'-Deoxy-5-fluorouridine	204
	2'-Deoxy-2'-fluorouridine	204
	2'-Deoxy-2'-fluoro-L-uridine	204
	1-(2'-Deoxy-2'-fluoro-b-L-arabinofuranosyl)-uracil	195
	1-(2'-Deoxy-2'-fluoro-b-D-arabinofuranosyl)uracil	194
C <sub>9</sub> H <sub>11</sub> IN <sub>2</sub> O <sub>5</sub>	3'-epi-iodoxuridine	268
	ent-iodoxuridine	267
	2'-Deoxy-5-iodouridine	210
C <sub>9</sub> H <sub>11</sub> N <sub>5</sub> O <sub>5</sub>	3'-Azido-3'-deoxyuridine	89
	3'-Azido-3'-deoxy-L-uridine	89
	2'-Azido-2'-deoxyuridine	88
C <sub>9</sub> H <sub>11</sub> BrN <sub>2</sub> O <sub>6</sub>	5-Bromouridine	129
C <sub>9</sub> H <sub>11</sub> ClN <sub>2</sub> O <sub>6</sub>	5-Chlorouridine	153
C <sub>9</sub> H <sub>11</sub> FN <sub>2</sub> O <sub>6</sub>	5-Fluorouridine	280
C <sub>9</sub> H <sub>11</sub> IN <sub>2</sub> O <sub>6</sub>	5-Iodouridine	295
	1-(b-D-Arabinofuranosyl)-5-iodouracil	74
C <sub>9</sub> H <sub>11</sub> N <sub>5</sub> O <sub>6</sub>	5-Azidouridine	92
C <sub>9</sub> H <sub>11</sub> N <sub>3</sub> O <sub>7</sub> PNa	Cytidine 3',5'-cyclic monophosphate monosodium salt	159
C <sub>9</sub> H <sub>11</sub> N <sub>3</sub> O <sub>7</sub> P·Na	Cytidine 2',3'-cyclic monophosphate monosodium salt	159
C <sub>9</sub> H <sub>11</sub> FIN <sub>2</sub> O <sub>8</sub> P	Flialuridine 5'-monophosphate	274
C <sub>9</sub> H <sub>11</sub> N <sub>2</sub> O <sub>9</sub> PNa <sub>2</sub>	2'-Deoxyuridine-5'-monophosphate disodium salt	224
C <sub>9</sub> H <sub>11</sub> N <sub>2</sub> Na <sub>2</sub> O <sub>9</sub> P	Uridine 5'-monophosphate disodium salt	380
	Uridine 3'-monophosphate disodium salt	380
C <sub>9</sub> H <sub>11</sub> FLi <sub>4</sub> N <sub>3</sub> O <sub>13</sub> P <sub>3</sub>	2'-Deoxy-2'-fluorocytidine-5'-triphosphate tetralithium salt	195
C <sub>9</sub> H <sub>11</sub> FN <sub>3</sub> O <sub>13</sub> P <sub>3</sub> ·Li <sub>4</sub>	2'-Deoxy-2'-fluorocytidine-5'-triphosphate lithium salt - 100mM aqueous solution	195
C <sub>9</sub> H <sub>11</sub> FN <sub>2</sub> O <sub>14</sub> P <sub>3</sub> Li <sub>4</sub>	2'-Deoxy-2'-fluorouridine-5'-triphosphate tetralithium salt	204
C <sub>9</sub> H <sub>12</sub> N <sub>4</sub>	6-Propylamino-7-deazapurine	344
C <sub>9</sub> H <sub>12</sub> N <sub>2</sub> O	2-tert-Butylpyrimidine-5-carbaldehyde	134
C <sub>9</sub> H <sub>12</sub> N <sub>2</sub> OS	2-(sec-Butylthio)pyrimidine-5-carbaldehyde	353
	2-(Butylthio)pyrimidine-5-carbaldehyde	134
C <sub>9</sub> H <sub>12</sub> FN <sub>3</sub> O <sub>3</sub>	1-(2,3-Dideoxy-2-fluoropentofuranosyl)cytosine	242
	b-L-2',3'-Dideoxy-5-fluorocytidine	242
	2',3'-Dideoxy-5-fluorocytidine	242
	2',3'-Dideoxy-3'-fluorocytidine	242
C <sub>9</sub> H <sub>12</sub> N <sub>3</sub> O <sub>3</sub> l	5-Iodo-2',3'-dideoxycytidine	294
C <sub>9</sub> H <sub>12</sub> Na <sub>3</sub> O <sub>3</sub>	2',3'-Dideoxy-5-iodocytidine	245
C <sub>9</sub> H <sub>12</sub> N <sub>6</sub> O <sub>3</sub>	5'-Azido-2',5'-dideoxycytidine	89
C <sub>9</sub> H <sub>12</sub> N <sub>2</sub> O <sub>4</sub>	2',5'-Dideoxyuridine	246
	2',3'-Dideoxyuridine	246
C <sub>9</sub> H <sub>12</sub> BrN <sub>3</sub> O <sub>4</sub>	5-Bromo-2'-deoxycytidine	124
C <sub>9</sub> H <sub>12</sub> ClN <sub>3</sub> O <sub>4</sub>	5-Chloro-5'-deoxycytidine	142
	2'-Chloro-2'-deoxycytidine	142
	1-(2'-Chloro-2'-deoxy-b-D-arabinofuranosyl)cytosine	142
C <sub>9</sub> H <sub>11</sub> N <sub>3</sub> O <sub>4</sub> ·HCl	2,2'-Anhydrocytidine HCl	67
C <sub>9</sub> H <sub>12</sub> FN <sub>3</sub> O <sub>4</sub>	5'-Deoxy-5-fluorocytidine	196
	2'-Deoxy-5-fluorocytidine	196
	2'-Deoxy-2'-fluorocytidine	196
C <sub>9</sub> H <sub>11</sub> F <sub>2</sub> N <sub>3</sub> O <sub>4</sub> ·HCl	2'-Deoxy-2',2'-difluorocytidine hydrochloride	178

Formula	Product Name	Page
C <sub>9</sub> H <sub>12</sub> IN <sub>3</sub> O <sub>4</sub>	2'-Deoxy-5-iodocytidine	209
C <sub>9</sub> H <sub>12</sub> N <sub>6</sub> O <sub>4</sub>	2'-Azido-2'-deoxycytidine	84
	8-Azaadenosine	75
	3'-Azido-3'-deoxycytidine	385
C <sub>9</sub> H <sub>12</sub> N <sub>2</sub> O <sub>4</sub> S	2'-Deoxy-4'-thiouridine	222
	2'-Deoxy-4'-thiouridine	221
C <sub>9</sub> H <sub>12</sub> N <sub>2</sub> O <sub>4</sub> S <sub>2</sub>	2,4-Dithiouridine	253
	2',3'-Dithiouridine	253
C <sub>9</sub> H <sub>12</sub> N <sub>2</sub> O <sub>5</sub>	5'-Deoxyuridine	226
	4-Deoxyuridine	225
	3'-Deoxyuridine	225
	2-Deoxyuridine	225
	2'-Deoxyuridine	225
	2'-Deoxy-L-uridine	225
	2'-Deoxy-a-uridine	225
	2'-Deoxypseudouridine	219
C <sub>9</sub> H <sub>12</sub> BrN <sub>3</sub> O <sub>5</sub>	5-Bromocytidine	124
C <sub>9</sub> H <sub>12</sub> ClN <sub>3</sub> O <sub>5</sub>	5-Chlorocytidine	140
C <sub>9</sub> H <sub>12</sub> FN <sub>3</sub> O <sub>5</sub>	5-Fluorocytidine	276
C <sub>9</sub> H <sub>12</sub> IN <sub>3</sub> O <sub>5</sub>	5-Iodocytidine	294
C <sub>9</sub> H <sub>12</sub> N <sub>2</sub> O <sub>5</sub> S	4-Thiouridine	362
	2-Thiouridine	361
C <sub>9</sub> H <sub>12</sub> N <sub>2</sub> O <sub>6</sub>	Uridine	382
	L-Uridine	382
	1-(a-D-Ribofuranosyl)uracil	352
	Pseudouridine	345
	2'-Deoxy-5-hydroxyuridine	208
<sup>13</sup> CC <sub>8</sub> H <sub>12</sub> N <sub>2</sub> O <sub>6</sub>	2'-13C Uridine	156
	1'-13C Uridine	155
C <sub>9</sub> H <sub>12</sub> N <sub>2</sub> O <sub>6</sub>	1-(b-D-Arabinofuranosyl)uracil	75
C <sub>9</sub> H <sub>12</sub> N <sub>2</sub> O <sub>7</sub>	5-Hydroxyuridine	291
C <sub>9</sub> H <sub>12</sub> N <sub>3</sub> O <sub>7</sub> PNa <sub>2</sub>	2'-Deoxycytidine-5'-monophosphate disodium salt	174
C <sub>9</sub> H <sub>12</sub> N <sub>3</sub> O <sub>7</sub> P·2Na	2'-Deoxycytidine-3'-monophosphate sodium salt	175
C <sub>9</sub> H <sub>12</sub> FN <sub>2</sub> O <sub>8</sub> P	2'-Deoxy-2'-fluorouridine-5'-monophosphate	203
C <sub>9</sub> H <sub>12</sub> BrN <sub>2</sub> O <sub>8</sub> PNa <sub>2</sub>	5-Bromo-2'-deoxyuridine-5'-monophosphate sodium salt	125
C <sub>9</sub> H <sub>12</sub> N <sub>3</sub> Na <sub>2</sub> O <sub>8</sub> P	Cytidine 5'-monophosphate disodium salt	160
C <sub>9</sub> H <sub>12</sub> FN <sub>2</sub> O <sub>9</sub> P	5-Fluorouridine-5'-monophosphate sodium salt - 10mM aqueous solution	280
C <sub>9</sub> H <sub>12</sub> N <sub>3</sub> O <sub>10</sub> P <sub>2</sub> ·Na <sub>3</sub>	2'-Deoxycytidine-5'-diphosphate trisodium salt hydrate	174
C <sub>9</sub> H <sub>12</sub> N <sub>2</sub> Na <sub>2</sub> O <sub>11</sub> P <sub>2</sub>	2'-Deoxyuridine-5'-diphosphate sodium salt	223
C <sub>9</sub> H <sub>12</sub> N <sub>3</sub> Na <sub>2</sub> O <sub>11</sub> P <sub>2</sub>	Cytidine-5'-diphosphate trisodium salt	160
C <sub>9</sub> H <sub>12</sub> N <sub>2</sub> O <sub>12</sub> P <sub>2</sub> Na <sub>2</sub>	Uridine 5'-diphosphate disodium salt	380
C <sub>9</sub> H <sub>12</sub> N <sub>2</sub> O <sub>14</sub> P <sub>3</sub> ·3Na	2'-Deoxyuridine-5'-triphosphate trisodium salt	224
C <sub>9</sub> H <sub>12</sub> N <sub>2</sub> O <sub>15</sub> P <sub>3</sub> Na <sub>3</sub>	Uridine 5'-triphosphate dihydrate trisodium salt	381
	Pseudouridine-5'-triphosphate - 100mM aqueous solution	345
C <sub>9</sub> H <sub>12</sub> N <sub>2</sub> O <sub>15</sub> P <sub>3</sub> ·3Na	Uridine 5'-triphosphate trisodium salt	381
C <sub>9</sub> H <sub>13</sub> N <sub>3</sub> O <sub>3</sub>	2',5'-Dideoxycytidine	241
	2',3'-Dideoxycytidine	240
C <sub>9</sub> H <sub>13</sub> ClN <sub>4</sub> O <sub>3</sub>	2-Chloro-6-(2'-deoxy-b-D-ribofuranosyl)-3,5-diaminopyrazine	144
C <sub>9</sub> H <sub>13</sub> N <sub>3</sub> O <sub>3</sub> S	4-(2-Methoxyethylamino)-2-(Methylthio)Pyrimidine-5-Carboxylic Acid	306
C <sub>9</sub> H <sub>13</sub> N <sub>3</sub> O <sub>4</sub>	2'-Deoxypseudoisocytidine	219
	2'-Deoxyisocytidine	212
	3'-Deoxycytidine	177
	2'-Deoxy-L-cytidine	177
	2'-Deoxycytidine	177
C <sub>9</sub> H <sub>12</sub> FN <sub>3</sub> O <sub>4</sub> ·HCl	1-(2'-Deoxy-2'-fluoro-b-D-arabinofuranosyl)cytosine HCl	193
C <sub>9</sub> H <sub>13</sub> N <sub>3</sub> O <sub>4</sub> S	2-Thiocytidine	359
C <sub>9</sub> H <sub>13</sub> N <sub>3</sub> O <sub>5</sub>	Pseudoisocytidine	345
	Isocytidine	298
	2'-Deoxy-5-hydroxycytidine	207
	L-Cytidine	162
	Cytidine	162
<sup>13</sup> CC <sub>8</sub> H <sub>13</sub> N <sub>3</sub> O <sub>5</sub>	2'-13CCytidine	138
	1'-13CCytidine	138
C <sub>9</sub> H <sub>13</sub> N <sub>3</sub> O <sub>5</sub>	1-(b-D-Arabinofuranosyl)cytosine	73
	3'-Amino-3'-deoxyuridine	49
	2'-Amino-2'-deoxyuridine	49

Formula	Product Name	Page
C <sub>9</sub> H <sub>13</sub> N <sub>3</sub> O <sub>6</sub>	Mizoribine	329
CaH <sub>13</sub> N <sub>3</sub> O <sub>6</sub> PS	2',3'-Dideoxyuridine-5'-O-monophosphate	246
CaH <sub>13</sub> FN <sub>3</sub> O <sub>7</sub> P	2'-Deoxy-2'-fluorocytidine-5'-monophosphate	195
CaH <sub>13</sub> N <sub>4</sub> O <sub>7</sub> P	AICAR 3',5'-cyclic phosphate	30
CaH <sub>13</sub> N <sub>2</sub> O <sub>9</sub> P	2'-Deoxyuridine-5'-monophosphate free acid	224
C <sub>9</sub> H <sub>13</sub> N <sub>2</sub> O <sub>9</sub> P	Uridine 5'-monophosphate	381
	1-b-D-Arabinofuranosyluracil 5'-monophosphate	75
CaH <sub>13</sub> N <sub>2</sub> O <sub>11</sub> P <sub>2</sub> B	5-Bromo-2'-deoxyuridine 5'-diphosphate sodium salt - 10mM aqueous solution	125
CaH <sub>13</sub> N <sub>3</sub> O <sub>11</sub> P <sub>2</sub> Na <sub>2</sub>	Cytidine 5'-diphosphate disodium salt	160
C <sub>9</sub> H <sub>13</sub> N <sub>3</sub> Na <sub>3</sub> O <sub>12</sub> P <sub>3</sub>	2',3'-Dideoxycytidine-5'-triphosphate trisodium salt	240
C <sub>9</sub> H <sub>13</sub> N <sub>3</sub> O <sub>13</sub> P <sub>3</sub> Na <sub>3</sub>	2'-Deoxycytidine-5'-triphosphate trisodium salt	176
CaH <sub>13</sub> N <sub>3</sub> O <sub>13</sub> P <sub>3</sub> ·3Na	2'-Deoxycytidine-5'-triphosphate trisodium salt	176
CaH <sub>13</sub> N <sub>2</sub> O <sub>15</sub> P <sub>3</sub> ·2Na	Uridine 5'-triphosphate disodium salt	381
CaH <sub>13</sub> N <sub>3</sub> O <sub>7</sub> ·HCl	2-(Piperidin-4-Yloxy)Pyrimidine Dihydrochloride	342
CaH <sub>14</sub> N <sub>4</sub> O <sub>3</sub>	3'-Amino-2',3'-dideoxycytidine	50
CaH <sub>13</sub> N <sub>3</sub> O <sub>4</sub> ·HCl	2'-Deoxycytidine HCl	174
CaH <sub>14</sub> N <sub>4</sub> O <sub>4</sub>	3'-O-Amino-2'-deoxycytidine	46
	3'-Amino-3'-deoxycytidine	46
	2'-Amino-2'-deoxycytidine	45
CaH <sub>14</sub> N <sub>5</sub> O <sub>4</sub> P	(R)-9-[2-(Phosphonomethoxy)propyl]adenine	341
CaH <sub>14</sub> N <sub>2</sub> O <sub>5</sub>	5,6-Dihydro-2'-deoxyuridine	247
C <sub>9</sub> H <sub>13</sub> N <sub>3</sub> O <sub>5</sub> ·HCl	Pseudoisocytidine hydrochloride	345
	1-(b-D-Arabinofuranosyl)cytosine HCl	73
CaH <sub>14</sub> N <sub>4</sub> O <sub>5</sub>	N4-Methyl-5-azacytidine	312
	5-Aminoimidazole-4-carboxamide-1-b-D-ribofuranose	56
	N4-Aminocytidine	43
CaH <sub>14</sub> CIN <sub>3</sub> O <sub>6</sub>	5-Aminouridine hydrochloride	64
C <sub>9</sub> H <sub>14</sub> N <sub>3</sub> O <sub>6</sub> PS	2'-Deoxycytidine-5'-O-monophosphorothioate sodium salt	175
CaH <sub>14</sub> N <sub>3</sub> O <sub>7</sub> P	2'-Deoxycytidine-5'-monophosphate free acid	175
CaH <sub>14</sub> N <sub>3</sub> O <sub>8</sub> P·xLi	2'-Deoxycytidine-3'-monophosphate free acid	175
CaH <sub>14</sub> N <sub>3</sub> O <sub>8</sub> P	Cytidine 3'-monophosphate lithium salt	161
C <sub>9</sub> H <sub>14</sub> N <sub>3</sub> O <sub>8</sub> P	Cytidine 5'-monophosphate free acid	160
	Cytidine 3'(2')-monophosphate	161
	1-(b-D-Arabinofuranosyl)cytosine 5'-monophosphate	73
CaH <sub>14</sub> N <sub>3</sub> O <sub>8</sub> P·xNa	Cytidine-2'-monophosphate sodium salt	161
	Cytidine 5'-monophosphate sodium salt	161
CaH <sub>14</sub> N <sub>2</sub> O <sub>11</sub> P <sub>2</sub>	2'-Deoxyuridine-5'-diphosphate triethylammonium salt - 10 mM aqueous solution	223
CaH <sub>14</sub> FN <sub>2</sub> O <sub>12</sub> P <sub>2</sub>	5-Fluorouridine-5'-diphosphate sodium salt	280
CaH <sub>14</sub> N <sub>3</sub> O <sub>13</sub> P <sub>3</sub> ·xLi	3'-Azido-2',3'-dideoxyuridine-5'-triphosphate lithium salt - 100 mM aqueous solution	91
CaH <sub>14</sub> N <sub>2</sub> O <sub>14</sub> P <sub>3</sub> Br	5-Bromo-2'-deoxyuridine-5'-triphosphate sodium salt	125
CaH <sub>14</sub> N <sub>2</sub> O <sub>14</sub> P <sub>3</sub> F·xLi	2'-Deoxy-2'-fluorouridine-5'-triphosphate lithium salt - 100mM aqueous solution	203
CaH <sub>14</sub> N <sub>5</sub> O <sub>14</sub> P <sub>3</sub>	2'-Azido-2'-deoxyuridine-5'-triphosphate	88
CaH <sub>14</sub> FN <sub>2</sub> O <sub>14</sub> P <sub>3</sub> ·Na	2'-Deoxy-2'-fluorouridine-5'-triphosphate sodium salt - 100mM aqueous solution	203
CaH <sub>14</sub> N <sub>3</sub> Na <sub>2</sub> O <sub>14</sub> P <sub>3</sub>	Cytidine 5'-triphosphate disodium salt	161
CaH <sub>14</sub> N <sub>2</sub> O <sub>15</sub> P <sub>3</sub> F	5-Fluorouridine-5'-triphosphate sodium salt	280
CaH <sub>15</sub> N <sub>4</sub> O <sub>8</sub> P	5-Aminoimidazole-4-carboxamide-1-b-D-ribofuranose 5'-monophosphate	56
CaH <sub>15</sub> N <sub>3</sub> O <sub>10</sub> P <sub>2</sub>	2'-Deoxyuridine-5'-[(a,b)-imido]diphosphate sodium salt - 10mM aqueous solution	223
CaH <sub>15</sub> O <sub>12</sub> N <sub>6</sub> P <sub>3</sub> ·xLi	3'-Azido-2',3'-dideoxycytidine-5'-triphosphate lithium salt - 10 mM aqueous solution	89
C <sub>9</sub> H <sub>15</sub> N <sub>2</sub> O <sub>13</sub> P <sub>3</sub> ·xLi	2',3'-Dideoxyuridine-5'-triphosphate lithium salt - 100mM aqueous solution	246
CaH <sub>15</sub> FN <sub>3</sub> O <sub>13</sub> P <sub>3</sub>	2'-Deoxy-2'-fluorocytidine-5'-triphosphate sodium salt - 100mM aqueous solution	195
CaH <sub>15</sub> N <sub>6</sub> O <sub>13</sub> P <sub>3</sub>	2'-Azido-2'-deoxycytidine-5'-triphosphate	84
CaH <sub>15</sub> N <sub>2</sub> O <sub>14</sub> P <sub>3</sub> S	Uridine 5'-O-(1-thiotriphosphate) lithium salt - 100mM aqueous solution	381
CaH <sub>15</sub> N <sub>2</sub> O <sub>14</sub> P <sub>3</sub> S·4Na	4-Thiouridine-5'-triphosphate sodium salt	361
CaH <sub>16</sub> N <sub>3</sub> O <sub>12</sub> P <sub>3</sub>	2',3'-Dideoxycytidine-5'-triphosphate lithium salt - 100mM aqueous solution	240
CaH <sub>16</sub> N <sub>3</sub> O <sub>12</sub> P <sub>3</sub> ·xNa	2'-Deoxycytidine-5'-O-(1-thiotriphosphate) sodium salt - 10 mM aqueous solution	176

Formula	Product Name	Page
C <sub>9</sub> H <sub>16</sub> N <sub>3</sub> O <sub>12</sub> P <sub>3</sub> S·Li <sub>4</sub>	2'-Deoxycytidine-5'-O-(1-thiotriphosphate) lithium salt	176
CaH <sub>16</sub> N <sub>3</sub> O <sub>13</sub> P <sub>3</sub>	2'-Deoxyuridine-5'-[(a,b)-imido]triphosphate sodium salt - 10mM aqueous solution	224
	dCTP - 100mmol solution	164
C <sub>9</sub> H <sub>16</sub> N <sub>3</sub> O <sub>13</sub> P <sub>3</sub> S·xLi	Cytidine-5'-O-(1-thiotriphosphate) lithium salt - 100mM aqueous solution	161
C <sub>9</sub> H <sub>16</sub> N <sub>3</sub> O <sub>14</sub> P <sub>3</sub>	2'-Amino-2'-deoxyuridine-5'-triphosphate	49
CaH <sub>14</sub> N <sub>3</sub> O <sub>14</sub> P <sub>3</sub> ·2Na·2H <sub>2</sub> O	Cytidine 5'-triphosphate disodium salt dihydrate	161
CaH <sub>14</sub> N <sub>3</sub> O <sub>7</sub> P·2NH <sub>3</sub>	2'-Deoxycytidine-3'-monophosphate ammonium salt	174
C <sub>9</sub> H <sub>17</sub> N <sub>4</sub> O <sub>12</sub> P <sub>3</sub> ·xLi	3'-Amino-2',3'-dideoxycytidine-5'-triphosphate lithium salt - 100 mM aqueous solution	50
C <sub>9</sub> H <sub>17</sub> N <sub>4</sub> O <sub>13</sub> P <sub>3</sub>	3'-O-Amino-2'-deoxyuridine-5'-triphosphate	45
	2'-Amino-2'-deoxycytidine-5'-triphosphate	45
CaH <sub>17</sub> N <sub>4</sub> O <sub>14</sub> P <sub>3</sub>	5-Aminoimidazole-4-carboxamide-1-b-D-ribofuranosyl 5'-triphosphate	57
C <sub>10</sub> H <sub>8</sub> N <sub>10</sub>	6,6'-Azopurine	92
C <sub>10</sub> H <sub>7</sub> BrN <sub>2</sub> S	4-(4-Bromophenyl)pyrimidine-2-thiol	128
C <sub>10</sub> H <sub>7</sub> FN <sub>2</sub> S	4-(4-Fluorophenyl)pyrimidine-2-thiol	279
C <sub>10</sub> H <sub>7</sub> N <sub>3</sub> O	2-Pyridin-2-ylpyrimidine-5-carbaldehyde	346
C <sub>10</sub> H <sub>6</sub> BrN <sub>3</sub>	2-Amino-4-(4-bromophenyl)pyrimidine	39
C <sub>10</sub> H <sub>6</sub> CIN <sub>3</sub>	2-Amino-4-(4-chlorophenyl)pyrimidine	42
C <sub>10</sub> H <sub>6</sub> FN <sub>3</sub>	2-Amino-4-(4-fluorophenyl)pyrimidine	54
C <sub>10</sub> H <sub>8</sub> N <sub>2</sub> S	4-Phenylpyrimidine-2-thiol	340
C <sub>10</sub> H <sub>9</sub> D <sub>3</sub> N <sub>2</sub> O <sub>4</sub>	2,3'-Anhydrothymidine, methyl-D3	68
C <sub>10</sub> H <sub>9</sub> FN <sub>2</sub> O <sub>4</sub> D <sub>4</sub>	Clevudine-d4	154
C <sub>10</sub> H <sub>10</sub> Cl <sub>2</sub> N <sub>4</sub> O <sub>3</sub>	2,6-Dichloro-9-(2'-deoxy-b-D-ribofuranosyl)purine	236
C <sub>10</sub> H <sub>10</sub> ClFN <sub>4</sub> O <sub>3</sub>	6-Chloro-3'-deoxy-3'-fluorinosine	143
C <sub>10</sub> H <sub>10</sub> FNO <sub>4</sub>	4',5'-Dideohydro-2',5'-dideoxy-2'-fluorouridine	238
C <sub>10</sub> H <sub>10</sub> N <sub>4</sub> O <sub>4</sub>	2',3'-Anhydroinosine	68
C <sub>10</sub> H <sub>10</sub> Cl <sub>2</sub> N <sub>4</sub> O <sub>4</sub>	2,6-Dichloro-9-(b-D-ribofuranosyl)purine	238
C <sub>10</sub> H <sub>10</sub> D <sub>3</sub> N <sub>5</sub> O <sub>4</sub>	3'-Azido-3'-deoxythymidine methyl-D3	87
C <sub>10</sub> H <sub>10</sub> N <sub>2</sub> O <sub>5</sub> D <sub>4</sub>	Thymidine-a,a,a,6-D4	366
C <sub>10</sub> H <sub>10</sub> BrN <sub>5</sub> O <sub>5</sub> PS·Na	8-Bromoadenosine 3',5'-cyclic monophosphorothioate, Sp-isomer sodium salt	123
	8-Bromoadenosine 3',5'-cyclic monophosphorothioate, Rp-isomer sodium salt	122
C <sub>10</sub> H <sub>10</sub> BrN <sub>5</sub> O <sub>6</sub> P·Na	8-Bromoadenosine 3',5'-cyclic monophosphate sodium salt	122
C <sub>10</sub> H <sub>10</sub> BrN <sub>5</sub> NaO <sub>7</sub> P	8-Bromoguanosine 3',5'-cyclic monophosphate sodium salt	126
C <sub>10</sub> H <sub>10</sub> N <sub>2</sub> O <sub>11</sub> PNa <sub>3</sub>	Orotidine 5'-monophosphate trisodium salt	338
C <sub>10</sub> H <sub>11</sub> N <sub>5</sub> O <sub>2</sub>	2',3'-Dideoxy-2',3'-didehydroadenosine	241
C <sub>10</sub> H <sub>11</sub> CIN <sub>4</sub> O <sub>3</sub>	6-Chloro-9-(2'-deoxy-b-D-ribofuranosyl)purine	144
C <sub>10</sub> H <sub>11</sub> N <sub>5</sub> O <sub>3</sub>	2,3'-Anhydro-2'-deoxyadenosine	67
C <sub>10</sub> H <sub>11</sub> ClFN <sub>6</sub> O <sub>3</sub>	6-Amino-2-chloro-9-(2'-deoxy-2'-fluoro-b-D-arabinofuranosyl)purine	40
C <sub>10</sub> H <sub>11</sub> F <sub>2</sub> N <sub>5</sub> O <sub>3</sub>	2-Fluoro-9-(2'-deoxy-2'-fluoro-b-D-arabinofuranosyl)adenine	277
	9-(2'-Deoxy-2'-fluoro-b-D-ribofuranosyl)-2-fluoroadenine	201
C <sub>10</sub> H <sub>11</sub> N <sub>7</sub> O <sub>3</sub>	5'-Azido-2',5'-dideoxyinosine	90
C <sub>10</sub> H <sub>11</sub> ClN <sub>4</sub> O <sub>4</sub>	6-Chloro-9-(b-D-ribofuranosyl)purine	153
C <sub>10</sub> H <sub>11</sub> FN <sub>4</sub> O <sub>4</sub>	2'-Deoxy-2'-fluorinosine	198
	9-(2'-Deoxy-2'-fluoro-b-D-arabinofuranosyl)hypoxanthine	193
C <sub>10</sub> H <sub>11</sub> N <sub>5</sub> O <sub>4</sub>	8,5'-(S)-Cycloadenosine	157
C <sub>10</sub> H <sub>11</sub> N <sub>2</sub> O <sub>5</sub> D <sub>3</sub>	D3-Thymidine	365
C <sub>10</sub> H <sub>11</sub> F <sub>3</sub> N <sub>2</sub> O <sub>5</sub>	Trifluorothymidine	376
C <sub>10</sub> H <sub>11</sub> BrN <sub>4</sub> O <sub>5</sub>	8-Brominosine	127
C <sub>10</sub> H <sub>11</sub> CIN <sub>4</sub> O <sub>5</sub>	8-Chlorinosine	147
	2-Chlorinosine	147
C <sub>10</sub> H <sub>11</sub> FN <sub>4</sub> O <sub>5</sub>	2-Fluorinosine	278
C <sub>10</sub> H <sub>11</sub> N <sub>5</sub> O <sub>5</sub> PS·Na	Adenosine 3',5'-cyclic monophosphothioate Sp-isomer sodium salt	22
	Adenosine 3',5'-cyclic monophosphothioate Rp-isomer sodium salt	22
C <sub>10</sub> H <sub>11</sub> BrN <sub>5</sub> O <sub>6</sub> P	8-Bromoadenosine 3',5'-cyclic monophosphate	122
C <sub>10</sub> H <sub>11</sub> CIN <sub>5</sub> O <sub>6</sub> P	8-Chloroadenosine 3',5'-cyclic monophosphate	139
C <sub>10</sub> H <sub>11</sub> NaO <sub>6</sub> P	8-Azidoadenosine 3',5'-cyclic monophosphate free acid	79

# Formula Index

C<sub>10</sub>H<sub>13</sub>FN<sub>6</sub>O<sub>2</sub>

Formula	Product Name	Page	Formula	Product Name	Page
C <sub>10</sub> H <sub>11</sub> N <sub>5</sub> NaO <sub>6</sub> P	Adenosine 3',5'-cyclic monophosphate sodium salt	21	C <sub>10</sub> H <sub>12</sub> FN <sub>5</sub> O <sub>4</sub>	8-Fluoroadenosine	276
	Adenosine 2',3'-cyclic monophosphate sodium salt	21		2-Fluoroadenosine	276
C <sub>10</sub> H <sub>11</sub> N <sub>4</sub> O <sub>6</sub> P·Na <sub>2</sub>	2',3'-Dideoxyinosine-5'-monophosphate sodium salt	244		Fludarabine	274
C <sub>10</sub> H <sub>11</sub> N <sub>4</sub> O <sub>7</sub> P	Inosine-3',5'-cyclic-monophosphate free acid	292		9-(2'-Deoxy-2'-fluoro-b-D-ribofuranosyl)-isoguanine	201
C <sub>10</sub> H <sub>11</sub> N <sub>5</sub> NaO <sub>7</sub> P	Guanosine 3',5'-cyclic monophosphate sodium salt	283	C <sub>10</sub> H <sub>12</sub> N <sub>5</sub> O <sub>4</sub> F	3'-Deoxy-3'-fluoroguanosine	197
	Guanosine 2',3'-cyclic monophosphate sodium salt	283	C <sub>10</sub> H <sub>12</sub> FN <sub>5</sub> O <sub>4</sub>	2'-Deoxy-2'-fluoroguanosine	197
C <sub>10</sub> H <sub>11</sub> N <sub>4</sub> Na <sub>2</sub> O <sub>7</sub> P	2'-Deoxyinosine-5'-monophosphate disodium salt	208		9-(2'-Deoxy-2'-fluoro-b-D-ribofuranosyl)guanine	193
C <sub>10</sub> H <sub>11</sub> N <sub>4</sub> Na <sub>2</sub> O <sub>9</sub> P	Xanthosine 5'-monophosphate disodium salt	384	C <sub>10</sub> H <sub>12</sub> IN <sub>5</sub> O <sub>4</sub>	8-Iodoadenosine	293
C <sub>10</sub> H <sub>11</sub> N <sub>4</sub> O <sub>11</sub> P <sub>2</sub> ·3Na	Inosine 5'-diphosphate trisodium salt	292		2-Iodoadenosine	293
C <sub>10</sub> H <sub>11</sub> FN <sub>5</sub> O <sub>12</sub> P <sub>3</sub> ·4Li	2'-Deoxy-2'-fluoroadenosine-5'-triphosphate tetralithium salt	191		5'-Deoxy-5'-iodoguanosine	209
	2'-Deoxy-2'-fluoroadenosine-5'-triphosphate lithium salt - 100mM aqueous solution	191	C <sub>10</sub> H <sub>12</sub> N <sub>8</sub> O <sub>4</sub>	5'-Azido-5'-deoxyguanosine	86
C <sub>10</sub> H <sub>11</sub> FN <sub>5</sub> O <sub>13</sub> P <sub>3</sub> ·4Li	2'-Deoxy-2'-fluoroguanosine-5'-triphosphate lithium salt - 100mM aqueous solution	197		2'-Azido-2'-deoxyguanosine	86
C <sub>10</sub> H <sub>11</sub> N <sub>5</sub> O <sub>13</sub> P <sub>2</sub> S·4Li	2'-Phosphoadenosine 5'-phosphosulfate tetralithium salt (mixture with 3'-isomer)	341		8-Azidoadenosine	80
C <sub>10</sub> H <sub>12</sub> N <sub>4</sub>	6-Pyrrolidino-7-deazapurine	348	C <sub>10</sub> H <sub>12</sub> N <sub>4</sub> O <sub>4</sub> S	6-Thioinosine	360
C <sub>10</sub> H <sub>12</sub> FN <sub>5</sub> O <sub>2</sub>	2',3'-Dideoxy-3'-fluoroadenosine	241		6-Thio-9-(b-D-arabinofuranosyl)purine	358
	6-Amino-9-(2',3'-dideoxy-2'-fluoro-b-D-arabinofuranosyl)purine	51	C <sub>10</sub> H <sub>12</sub> N <sub>2</sub> O <sub>5</sub>	2,2'-Anhydrothymidine	68
C <sub>10</sub> H <sub>12</sub> N <sub>4</sub> O <sub>2</sub>	3'-Azido-2',3'-dideoxyadenosine	89		2,2'-Anhydro-L-thymidine	68
C <sub>10</sub> H <sub>12</sub> N <sub>4</sub> O <sub>2</sub> S	2',3'-Dideoxy-6-thio-inosine	246	C <sub>10</sub> H <sub>12</sub> F <sub>2</sub> N <sub>2</sub> O <sub>5</sub>	2'-Deoxy-2',2'-difluoro-5-methyluridine	179
C <sub>10</sub> H <sub>12</sub> N <sub>4</sub> O <sub>3</sub>	2',5'-Dideoxyinosine	245	CaH <sub>12</sub> CIN <sub>3</sub> O <sub>5</sub>	5-Chloro-1-(b-D-arabinofuranosyl)cytidine	140
	2',3'-Dideoxyinosine	244	C <sub>10</sub> H <sub>12</sub> N <sub>4</sub> O <sub>5</sub>	4-(b-D-Ribofuranosyl)-vic-triazolo[4,5-b]pyridin-5-one	352
C <sub>10</sub> H <sub>12</sub> BrN <sub>5</sub> O <sub>3</sub>	8-Bromo-2'-deoxyadenosine	124		L-Inosine	293
C <sub>10</sub> H <sub>12</sub> CIN <sub>5</sub> O <sub>3</sub>	6-Chloro-9-(2'-deoxy-b-L-erythro-pentofuranosyl)-9H-purin-2-amine	143		Inosine	293
	8-Chloro-2'-deoxyadenosine	142		2'-Deoxyxanthosine	226
	5'-Chloro-5'-deoxyadenosine	142		8-(2-Deoxy-b-D-ribofuranosyl)-imidazo[1,2-a]-1,3,5-triazine-2,4(3H,8H)-dione	220
	2-Chloro-2'-deoxyadenosine	141		9-(b-D-Arabinofuranosyl)hypoxanthine	74
	2-Amino-6-chloro-9-(2'-deoxy-b-D-ribofuranosyl)purine	41	C <sub>10</sub> H <sub>12</sub> BrN <sub>5</sub> O <sub>5</sub>	Allopurinol riboside	31
C <sub>10</sub> H <sub>12</sub> FN <sub>5</sub> O <sub>3</sub>	2',3'-Dideoxy-3'-fluoroguanosine	242		8-Bromoguanosine	127
	9-(2-Deoxy-2'-fluoro-b-D-xylofuranosyl)-9H-purin-6-amine	195	C <sub>10</sub> H <sub>12</sub> CIN <sub>5</sub> O <sub>5</sub>	8-Chloroguanosine	146
	9-(2'-Deoxy-2'-fluoro-b-D-arabinofuranosyl)adenine	192	C <sub>10</sub> H <sub>12</sub> N <sub>2</sub> O <sub>6</sub>	2'-Deoxy-5-formyluridine	205
	3'-Deoxy-3'-fluoroadenosine	192		2,3'-Anhydro-1-b-D-fructofuranosyluracil	68
	3'-Deoxy-2'-fluoroadenosine	192	C <sub>10</sub> H <sub>12</sub> N <sub>4</sub> O <sub>6</sub>	Xanthosine	384
	2'-Deoxy-2'-fluoroadenosine	192	C <sub>10</sub> H <sub>12</sub> N <sub>5</sub> O <sub>6</sub> P	Adenosine 3',5'-cyclic monophosphate	22
	2'-Deoxy-2'-fluoroadenosine	192	C <sub>10</sub> H <sub>12</sub> N <sub>5</sub> Na <sub>2</sub> O <sub>6</sub> P	2'-Deoxyadenosine-5'-monophosphate disodium salt	171
	9-(2-Deoxy-2'-fluoro-a-D-arabinofuranosyl)-9H-purin-6-amine	191	C <sub>10</sub> H <sub>12</sub> N <sub>4</sub> O <sub>6</sub> S	8-Oxo-7-thioguanosine	338
C <sub>10</sub> H <sub>12</sub> IN <sub>5</sub> O <sub>3</sub>	5'-Deoxy-5'-iodoadenosine	208	C <sub>10</sub> H <sub>12</sub> N <sub>2</sub> O <sub>7</sub>	1-(b-D-Ribofuranosyl)-5-nitropyridine-2-one	351
C <sub>10</sub> H <sub>12</sub> N <sub>6</sub> O <sub>3</sub>	3'-Azido-2',3'-dideoxyguanosine	90		5-Carboxy-2'-deoxyuridine	137
	8-Azido-2'-deoxyadenosine	84	C <sub>10</sub> H <sub>12</sub> N <sub>6</sub> O <sub>7</sub>	8-Nitroguanosine	335
	5'-Azido-5'-deoxyadenosine	84	C <sub>10</sub> H <sub>12</sub> FN <sub>4</sub> O <sub>7</sub> P·xLi	2'-Deoxy-2'-fluoroinosine 5'-monophosphate lithium salt	198
C <sub>10</sub> H <sub>12</sub> N <sub>4</sub> O <sub>3</sub> S	6-Mercapto-9-(2'-deoxy-b-D-ribofuranosyl)purine	305	C <sub>10</sub> H <sub>12</sub> N <sub>5</sub> O <sub>7</sub> P	Guanosine 3',5'-cyclic monophosphate	283
C <sub>10</sub> H <sub>12</sub> N <sub>2</sub> O <sub>4</sub>	2',3'-Dideoxy-2',3'-dideoxythymidine	239	C <sub>10</sub> H <sub>12</sub> N <sub>5</sub> Na <sub>2</sub> O <sub>7</sub> P	2'-Deoxyguanosine-5'-monophosphate disodium salt	205
	2,5'-Anhydro-thymidine	69	C <sub>10</sub> H <sub>12</sub> N <sub>5</sub> O <sub>7</sub> P·2Na	2'-Deoxyguanosine 3'-monophosphate sodium salt	206
C <sub>10</sub> H <sub>12</sub> N <sub>3</sub> O <sub>4</sub> D <sub>3</sub>	3'-Amino-3'-deoxy-D <sub>3</sub> -thymidine	48		Adenosine 5'-monophosphate disodium salt	24
C <sub>10</sub> H <sub>12</sub> FN <sub>3</sub> O <sub>4</sub>	(E)-2'-Deoxy-2'-(fluoromethylene)cytidine	200	C <sub>10</sub> H <sub>12</sub> N <sub>2</sub> O <sub>8</sub>	Orotidine	338
C <sub>10</sub> H <sub>12</sub> F <sub>3</sub> N <sub>3</sub> O <sub>4</sub>	5-(Trifluoromethyl)-2'-deoxycytidine	375	C <sub>10</sub> H <sub>12</sub> CaN <sub>5</sub> O <sub>8</sub> P	Guanosine 5'-monophosphate calcium salt	284
CaH <sub>12</sub> CIN <sub>3</sub> O <sub>4</sub>	5-Chloro-2'-deoxycytidine	142	C <sub>10</sub> H <sub>10</sub> CIN <sub>4</sub> Na <sub>2</sub> O <sub>7</sub> PH <sub>2</sub> O	6-Chloropurine riboside 5'-monophosphate disodium salt	152
C <sub>10</sub> H <sub>12</sub> N <sub>4</sub> O <sub>4</sub>	9-(b-D-Ribofuranosyl)purine	351	C <sub>10</sub> H <sub>12</sub> N <sub>5</sub> O <sub>8</sub> PN <sub>2</sub>	Guanosine-2'(&3')-monophosphate disodium salt (mixed isomers)	286
	2',3'-Dideoxyxanthosine	246	13Cs <sub>5</sub> CaH <sub>12</sub> N <sub>5</sub> O <sub>8</sub> P·2Na	Guanosine 5'-monophosphate disodium salt [1',2',3',4',5'-13CS]	284
	2'-Deoxyinosine	208	C <sub>10</sub> H <sub>12</sub> N <sub>5</sub> O <sub>8</sub> P·2Na	Guanosine 5'-monophosphate disodium salt	284
	2'-Cyano-2'-deoxy-1-(b-D-arabinofuranosyl)cytosine	156	C <sub>10</sub> H <sub>12</sub> N <sub>5</sub> O <sub>8</sub> P <sub>2</sub> ·xNa	2'-Deoxyadenosine-5'-diphosphate sodium salt	171
C <sub>10</sub> H <sub>12</sub> BrN <sub>5</sub> O <sub>4</sub>	8-Bromo-2'-deoxyguanosine	124	C <sub>10</sub> H <sub>12</sub> N <sub>5</sub> O <sub>10</sub> P <sub>2</sub> ·Li <sub>3</sub>	Adenosine 5'-diphosphate trilithium salt	24
	8-Bromoadenosine	123	C <sub>10</sub> H <sub>12</sub> N <sub>5</sub> O <sub>10</sub> P <sub>2</sub> S·3Li	Guanosine 5'-O-(2-thiodiphosphate) trilithium salt	285
	2-Bromoadenosine	123	C <sub>10</sub> H <sub>12</sub> N <sub>4</sub> O <sub>11</sub> P <sub>2</sub> ·2Na	Inosine 5'-diphosphate disodium salt	292
	2-Amino-8-bromo-9-(b-D-ribofuranosyl)purine	39	C <sub>10</sub> H <sub>12</sub> N <sub>5</sub> O <sub>11</sub> P <sub>3</sub> ·4Li	2',3'-Dideoxyadenosine-5'-triphosphate lithium salt - 100mM aqueous solution	240
C <sub>10</sub> H <sub>12</sub> CIN <sub>5</sub> O <sub>4</sub>	8-Chloro-2'-deoxyguanosine	143		2',3'-Dideoxyinosine-5'-triphosphate trisodium salt	244
	8-Chloro-2'-deoxyguanosine	140	C <sub>10</sub> H <sub>12</sub> N <sub>8</sub> O <sub>13</sub> P <sub>3</sub> ·Na <sub>3</sub>	8-Azidoadenosine 5'-triphosphate sodium salt - 10mM aqueous solution	79
	2-Chloro-2'-deoxyadenosine	140	C <sub>10</sub> H <sub>12</sub> N <sub>5</sub> O <sub>13</sub> P <sub>3</sub> Na <sub>4</sub>	L-Adenosine 5'-triphosphate sodium salt	27
	2-Amino-6-chloro-9-(b-D-ribofuranosyl)purine	43	C <sub>10</sub> H <sub>12</sub> N <sub>4</sub> O <sub>14</sub> P <sub>3</sub> ·Na <sub>3</sub>	Inosine 5'-triphosphate trisodium salt	293
			C <sub>10</sub> H <sub>13</sub> N <sub>5</sub> O <sub>2</sub>	2',5'-Dideoxyadenosine	240
				2',3'-Dideoxyadenosine	240
			C <sub>10</sub> H <sub>13</sub> FN <sub>6</sub> O <sub>2</sub>	3'-Amino-2',3'-dideoxy-2'-fluoroadenosine	51

Formula	Product Name	Page	Formula	Product Name	Page
C <sub>10</sub> H <sub>13</sub> N <sub>5</sub> O <sub>2</sub> S	2'-Deoxy-4'-thioadenosine	221	C <sub>10</sub> H <sub>13</sub> FN <sub>5</sub> O <sub>7</sub> P	Fludarabine phosphate	274
C <sub>10</sub> H <sub>13</sub> N <sub>5</sub> O <sub>3</sub>	2',5'-Dideoxyguanosine	244		2'-Deoxy-2'-fluoroguanosine-5'-monophosphate	197
	2',3'-Dideoxyguanosine	243	C <sub>10</sub> H <sub>13</sub> N <sub>5</sub> O <sub>7</sub> P	8-Azidoadenosine 5'-monophosphate sodium salt	79
	5'-Deoxyadenosine	173	C <sub>10</sub> H <sub>13</sub> N <sub>2</sub> O <sub>7</sub> P·xNa	Stavudine 5'-monophosphate sodium salt - 10 mM aqueous solution	353
	3'-Deoxyadenosine	173	C <sub>10</sub> H <sub>13</sub> N <sub>5</sub> NaO <sub>7</sub> P	3'-Azido-3'-deoxythymidine 5'-monophosphate sodium salt	87
	2'-Deoxy-L-adenosine	173	C <sub>10</sub> H <sub>13</sub> N <sub>5</sub> O <sub>7</sub> P·Na	Adenosine 5'-monophosphate sodium salt	25
	2'-Deoxyadenosine	173	C <sub>10</sub> H <sub>11</sub> ClN <sub>5</sub> O <sub>6</sub> P·2H <sub>2</sub> O	8-Chloroadenosine 3',5'-cyclic monophosphate dihydrate	139
	2'-Deoxy-a-adenosine	172	C <sub>10</sub> H <sub>13</sub> N <sub>4</sub> O <sub>7</sub> PS	6-Thioinosine 5'-monophosphate	360
	8-Aza-7'-deaza-2'-deoxyadenosine	77	C <sub>10</sub> H <sub>13</sub> N <sub>5</sub> O <sub>7</sub> PS·Na	6-Thioguanosine-5'-O-monophosphate sodium salt	359
	3'-Amino-2',3'-dideoxyinosine	51	C <sub>10</sub> H <sub>13</sub> N <sub>4</sub> O <sub>8</sub> P	Inosine 5'-monophosphate	292
	2-Amino-9-(2'-deoxy-b-D-ribofuranosyl)purine	48	C <sub>10</sub> H <sub>13</sub> BrN <sub>5</sub> O <sub>6</sub> P	8-Bromoguanosine-5'-monophosphate	127
C <sub>10</sub> H <sub>13</sub> FN <sub>6</sub> O <sub>3</sub>	2,6-Diamino-9-(2'-deoxy-2'-fluoro-b-D-ribofuranosyl)purine	230	C <sub>10</sub> H <sub>13</sub> N <sub>2</sub> Na <sub>2</sub> O <sub>6</sub> P	Thymidine-5'-monophosphate disodium salt	364
	2,6-Diamino-9-(2'-deoxy-2'-fluoro-b-D-arabinofuranosyl)purine	230	C <sub>10</sub> H <sub>11</sub> N <sub>4</sub> O <sub>6</sub> PN <sub>2</sub> ·xH <sub>2</sub> O	Inosine 5'-monophosphate disodium salt hydrate	292
	2-Amino-2'-deoxy-2'-fluoroadenosine	46	C <sub>10</sub> H <sub>13</sub> N <sub>5</sub> O <sub>10</sub> P <sub>2</sub> Ba	Adenosine 3',5'-diphosphate barium salt	23
C <sub>10</sub> H <sub>13</sub> N <sub>5</sub> O <sub>2</sub> S	2'-Deoxy-6-thioguanosine	221	C <sub>10</sub> H <sub>13</sub> N <sub>5</sub> O <sub>10</sub> P <sub>2</sub> ·2Na	2'-Deoxyguanosine-5'-diphosphate disodium salt	205
C <sub>10</sub> H <sub>13</sub> FN <sub>2</sub> O <sub>4</sub>	5'-Deoxy-5'-fluorothymidine	202		Adenosine 5'-diphosphate disodium salt	23
	3'-Deoxy-3'-fluorothymidine	202	C <sub>10</sub> H <sub>13</sub> N <sub>2</sub> Na <sub>3</sub> O <sub>11</sub> P <sub>2</sub>	Thymidine-5'-diphosphate trisodium salt	363
C <sub>10</sub> H <sub>13</sub> IN <sub>2</sub> O <sub>4</sub>	5'-Deoxy-5'-iodothymidine	210	C <sub>10</sub> H <sub>13</sub> N <sub>5</sub> O <sub>11</sub> P <sub>2</sub> ·2Na	Guanosine 5'-diphosphate disodium salt	283
	3'-Deoxy-3'-iodothymidine	209	C <sub>10</sub> H <sub>13</sub> N <sub>5</sub> O <sub>12</sub> P <sub>3</sub> ·3Na	2'-Deoxyadenosine-5'-triphosphate trisodium salt	172
C <sub>10</sub> H <sub>13</sub> N <sub>3</sub> O <sub>4</sub>	Cyclopentenyl cytosine	158	C <sub>10</sub> H <sub>13</sub> N <sub>5</sub> O <sub>13</sub> P <sub>3</sub> ·3Na	2'-Deoxyguanosine-5'-triphosphate trisodium salt	206
C <sub>10</sub> H <sub>13</sub> N <sub>5</sub> O <sub>4</sub>	9-(2-Deoxy-b-D-ribofuranosyl)isoguanine	220	C <sub>10</sub> H <sub>13</sub> N <sub>4</sub> O <sub>14</sub> P <sub>3</sub> ·2Na	Inosine 5'-triphosphate disodium salt	293
	2'-Deoxy-8-oxo-adenosine	217	C <sub>10</sub> H <sub>13</sub> N <sub>4</sub> O <sub>15</sub> P <sub>3</sub> ·2Na	Xanthosine 5'-triphosphate disodium salt	384
	3'-Deoxyguanosine	207	C <sub>10</sub> H <sub>13</sub> N <sub>2</sub> O <sub>15</sub> P <sub>3</sub> ·Li <sub>4</sub>	3'-O-Methyluridine-5'-triphosphate lithium salt	327
	2'-Deoxy-L-guanosine	207	C <sub>10</sub> H <sub>13</sub> N <sub>2</sub> O <sub>15</sub> P <sub>3</sub> Li <sub>4</sub>	2'-C-Methyluridine 5'-triphosphate lithium salt - 10mM aqueous solution	326
	2'-Deoxy-a-guanosine	206	C <sub>10</sub> H <sub>14</sub> N <sub>6</sub> O <sub>2</sub>	3'-Amino-2',3'-dideoxyadenosine	50
	5'-Azido-5'-deoxythymidine	88	C <sub>10</sub> H <sub>14</sub> N <sub>6</sub> O <sub>3</sub>	3'-Amino-2',3'-dideoxyguanosine	51
	3'-Azido-3'-deoxythymidine	88		5'-Amino-5'-deoxyadenosine hydrochloride	44
	8-Aza-7'-deaza-2'-deoxyguanosine	77		3'-O-Amino-2'-deoxyadenosine	45
	9-(b-D-Arabinofuranosyl)adenine	72		3'-Amino-3'-deoxyadenosine	45
	2-Amino-9-(b-D-ribofuranosyl)purine	62		2-Amino-2'-deoxyadenosine	45
	2-Amino-8-(2-deoxy-b-D-ribofuranosyl)-imidazo[1,2-a]-1,3,5-triazin-4(8H)-one	48		2'-Amino-2'-deoxyadenosine	45
	2'-Amino-2'-deoxyinosine	47	C <sub>10</sub> H <sub>14</sub> N <sub>2</sub> O <sub>4</sub>	5'-Deoxythymidine	222
	L-Adenosine	27		3'-Deoxythymidine	222
	Adenosine - Endotoxin level below 1000 EU/g	27		3'-Deoxy-L-thymidine	222
	Adenosine - Endotoxin level below 100 EU/g	27	C <sub>10</sub> H <sub>14</sub> FN <sub>3</sub> O <sub>4</sub>	2'-Deoxy-2'-fluoro-5-methylcytidine	199
	Adenosine	27	C <sub>10</sub> H <sub>13</sub> N <sub>5</sub> O <sub>5</sub> HCl	Adenosine HCl	24
C <sub>10</sub> H <sub>13</sub> N <sub>3</sub> O <sub>4</sub> S	5'-O-Acetylamilivudine	19	C <sub>10</sub> H <sub>14</sub> N <sub>6</sub> O <sub>4</sub>	2,6-Diamino-9-(b-D-arabinofuranosyl)purine	230
C <sub>10</sub> H <sub>13</sub> N <sub>6</sub> O <sub>4</sub> S	4-Thioguanosine	360		5'-Amino-5'-deoxyguanosine	47
	2-Thioadenosine	358		3'-Amino-3'-deoxyguanosine	47
C <sub>10</sub> H <sub>13</sub> ClN <sub>2</sub> O <sub>5</sub>	1-(2-Deoxy-2'-chloro-b-L-arabinofuranosyl)-thymine	173		2'-Amino-2'-deoxyguanosine	47
C <sub>10</sub> H <sub>13</sub> FN <sub>2</sub> O <sub>5</sub>	2'-Deoxy-2'-fluoro-5-methyluridine	200		8-Aminoadenosine	33
	2'-Deoxy-2'-fluoro-2'-C-methyluridine	200		2-Aminoadenosine	33
	1-(2'-Deoxy-2'-fluoro-a-L-arabinofuranosyl)-thymine	194	C <sub>10</sub> H <sub>14</sub> N <sub>2</sub> O <sub>4</sub> S	4-Thiothymidine	361
	1-(2-Deoxy-2'-fluoro-b-D-arabinofuranosyl)-5-methyluracil	194		2-Thiothymidine	361
	Clevudine	153		4-Thio-2'-deoxythymidine	359
C <sub>10</sub> H <sub>13</sub> N <sub>3</sub> O <sub>5</sub>	2'-Deoxy-5-formylcytidine	205	C <sub>10</sub> H <sub>14</sub> N <sub>5</sub> O <sub>4</sub> PS	2',3'-Dideoxyadenosine-5'-monothiophosphate	239
C <sub>10</sub> H <sub>13</sub> N <sub>5</sub> O <sub>5</sub>	9-(b-D-Ribofuranosyl)isoguanine	351	C <sub>10</sub> H <sub>14</sub> N <sub>2</sub> O <sub>5</sub>	Thymidine	365
	8-Hydroxyadenosine	288		L-Thymidine	365
	L-Guanosine	286		a-Thymidine	365
	2'-Deoxy-8-oxoguanosine	218		Pseudothymidine	345
	5-Aza-7'-deazaguanosine	77		3'-Deoxy-5-methyluridine	217
	9-(b-D-Arabinofuranosyl)isoguanine	74		3'-Deoxy-3'-C-methyluridine	216
	9-(b-L-Arabinofuranosyl)guanine	74		2'-Deoxy-N3-methyluridine	216
	9-(b-D-Arabinofuranosyl)guanine	74	C <sub>10</sub> H <sub>12</sub> ClN <sub>5</sub> O <sub>4</sub> ·½H <sub>2</sub> O	2-Chloroadenosine hemihydrate	139
C <sub>10</sub> H <sub>13</sub> N <sub>5</sub> <sup>18</sup> OO <sub>4</sub>	[2'- <sup>18</sup> O]Guanosine	286	C <sub>10</sub> H <sub>14</sub> N <sub>6</sub> O <sub>5</sub>	8-Aminoguanosine	54
C <sub>10</sub> H <sub>13</sub> N <sub>5</sub> O <sub>5</sub> S	8-Thioguanosine	360	C <sub>10</sub> H <sub>13</sub> N <sub>5</sub> O <sub>6</sub> P	2',3'-Dideoxyadenosine-5'-monophosphate	239
C <sub>10</sub> H <sub>13</sub> NO <sub>6</sub>	3-Deazauidine	170	C <sub>10</sub> H <sub>14</sub> N <sub>2</sub> O <sub>5</sub> S	5-Methyl-2-thiouridine	326
C <sub>10</sub> H <sub>13</sub> FN <sub>2</sub> O <sub>6</sub>	5-Fluoro-2'-O-methyluridine	278	C <sub>10</sub> H <sub>14</sub> N <sub>2</sub> O <sub>6</sub>	N3-Methyluridine	328
C <sub>10</sub> H <sub>13</sub> IN <sub>2</sub> O <sub>6</sub>	5-Iodo-2'-O-methyluridine	295		6-Methyluridine	328
C <sub>10</sub> H <sub>13</sub> N <sub>3</sub> O <sub>6</sub>	5-Formylcytidine	281		5-Methyluridine	328
	3,4-Dihydro-3-oxo-4-b-D-ribofuranosyl-2-pyrazinecarboxamide	248		5-Methyl-L-uridine	327
	6-Amino-5-nitro-3-(2'-deoxy-b-D-ribofuranosyl)-2(1H)-pyridone	59		3'-O-Methyluridine	327
	8-Oxoguanosine	338		2'-O-Methyluridine	327
C <sub>10</sub> H <sub>13</sub> N <sub>5</sub> O <sub>6</sub>	8-Oxoguanosine	338		2'-C-Methyluridine	327
C <sub>10</sub> H <sub>13</sub> FN <sub>5</sub> O <sub>6</sub> P	2'-Deoxy-2'-fluoroadenosine-5'-monophosphate	191		1-Methylpseudouridine	322
C <sub>10</sub> H <sub>13</sub> FN <sub>6</sub> O <sub>6</sub> S	4'-C-Fluoroadenosine 5'-sulfamate	275		2'-Deoxy-5-hydroxymethyluridine	208
C <sub>10</sub> H <sub>13</sub> ClN <sub>5</sub> O <sub>7</sub> P	8-Chloroadenosine-5'-monophosphate	139		1-(b-D-Arabinofuranosyl)thymine	74
			C <sub>10</sub> H <sub>12</sub> BrN <sub>5</sub> O <sub>5</sub> ·xH <sub>2</sub> O	8-Bromoguanosine hydrate	126

# Formula Index

C<sub>10</sub>H<sub>17</sub>ClN<sub>5</sub>O<sub>12</sub>P<sub>3</sub>

Formula	Product Name	Page	Formula	Product Name	Page
C <sub>10</sub> H <sub>14</sub> N <sub>5</sub> O <sub>6</sub> P	2',3'-Dideoxyguanosine-5'-triphosphate	243	C <sub>10</sub> H <sub>15</sub> FNO <sub>12</sub> P <sub>3</sub>	2'-Deoxy-2'-fluoroadenosine-5'-triphosphate	191
C <sub>10</sub> H <sub>14</sub> N <sub>5</sub> O <sub>6</sub> P	2'-Deoxyadenosine-5'-monophosphate free acid	171	C <sub>10</sub> H <sub>15</sub> N <sub>4</sub> O <sub>12</sub> P <sub>3</sub>	2',3'-Dideoxyinosine-5'-triphosphate triethylammonium salt	244
C <sub>10</sub> H <sub>14</sub> N <sub>5</sub> O <sub>6</sub> P·Na	2'-Deoxyadenosine-3'-monophosphate sodium salt	172	C <sub>10</sub> H <sub>15</sub> N <sub>5</sub> O <sub>12</sub> P <sub>3</sub> ·xLi	3'-Azido-2',3'-dideoxyguanosine-5'-triphosphate lithium salt - 100mM aqueous solution	90
C <sub>10</sub> H <sub>14</sub> N <sub>5</sub> O <sub>6</sub> P·xNa	2'-Deoxyadenosine 5'-monophosphate sodium salt	172	C <sub>10</sub> H <sub>15</sub> N <sub>8</sub> O <sub>12</sub> P <sub>3</sub>	2'-Azido-2'-deoxyadenosine-5'-triphosphate lithium salt	84
C <sub>10</sub> H <sub>14</sub> N <sub>2</sub> O <sub>7</sub>	5-Methoxyuridine	308	C <sub>10</sub> H <sub>15</sub> FNO <sub>12</sub> P <sub>3</sub> ·xNa	2'-Deoxy-2'-fluoroadenosine-5'-triphosphate sodium salt - 100mM aqueous solution	191
C <sub>10</sub> H <sub>14</sub> N <sub>5</sub> O <sub>7</sub> P	2'-Deoxyguanosine-5'-monophosphate free acid	206	C <sub>10</sub> H <sub>15</sub> N <sub>4</sub> O <sub>13</sub> P <sub>3</sub>	Purine riboside-5'-triphosphate	345
C <sub>10</sub> H <sub>14</sub> N <sub>5</sub> O <sub>7</sub> P·xLi	3'-Azido-3'-deoxythymidine-5'-monophosphate lithium salt - 100 mM aqueous solution	87	C <sub>10</sub> H <sub>15</sub> ClN <sub>5</sub> O <sub>13</sub> P <sub>3</sub>	2-Amino-6-chloro-(b-D-ribofuranosyl)purine-5'-triphosphate	42
C <sub>10</sub> H <sub>14</sub> N <sub>5</sub> O <sub>7</sub> P	9-(b-D-Arabinofuranosyl)adenine 5'-monophosphate	72	C <sub>10</sub> H <sub>15</sub> FN <sub>5</sub> O <sub>13</sub> P <sub>3</sub>	2-Fluoroadenosine 5'-triphosphate	275
	Adenosine-3'-monophosphate	25	C <sub>10</sub> H <sub>15</sub> FN <sub>5</sub> O <sub>13</sub> P <sub>3</sub> ·xLi	2'-Deoxy-2'-fluoroguanosine-5'-triphosphate tetralithium salt	197
	Adenosine-2'-monophosphate	25	C <sub>10</sub> H <sub>15</sub> N <sub>5</sub> O <sub>13</sub> P <sub>3</sub>	2'-Azido-2'-deoxyguanosine-5'-triphosphate lithium salt - 100mM aqueous solution	85
	Adenosine 5'-monophosphate	25		8-Azidoadenosine 5'-triphosphate tetralithium salt	79
C <sub>10</sub> H <sub>14</sub> N <sub>5</sub> O <sub>7</sub> P·2Na	2'-Deoxy-5'-methylcytidine-5'-monophosphate disodium salt	214	C <sub>10</sub> H <sub>15</sub> N <sub>2</sub> O <sub>13</sub> P <sub>3</sub> ·xNa	Stavudine 5'-triphosphate sodium salt - 10 mM aqueous solution	353
C <sub>10</sub> H <sub>14</sub> N <sub>5</sub> O <sub>8</sub> P	Guanosine 5'-monophosphate	284	C <sub>10</sub> H <sub>15</sub> N <sub>4</sub> O <sub>13</sub> P <sub>3</sub> ·xNa	2'-Deoxyinosine-5'-triphosphate sodium salt	208
C <sub>10</sub> H <sub>12</sub> N <sub>4</sub> O <sub>6</sub> ·2H <sub>2</sub> O	Xanthosine dihydrate	383	C <sub>10</sub> H <sub>15</sub> FN <sub>5</sub> O <sub>13</sub> P <sub>3</sub> ·xLi	2'-Deoxy-2'-fluoroguanosine-5'-triphosphate sodium salt - 100mM aqueous solution	197
C <sub>10</sub> H <sub>14</sub> FN <sub>5</sub> O <sub>9</sub> P <sub>2</sub>	2'-Deoxy-2'-fluoroadenosine-5'-diphosphate	191	C <sub>10</sub> H <sub>15</sub> N <sub>5</sub> O <sub>13</sub> P <sub>3</sub>	2'-Azido-2'-deoxyguanosine-5'-triphosphate lithium salt - 100mM aqueous solution	85
C <sub>10</sub> H <sub>14</sub> N <sub>5</sub> O <sub>10</sub> P <sub>2</sub> ·K	Adenosine 5'-diphosphate potassium salt	23		8-Azidoadenosine 5'-triphosphate tetralithium salt	79
C <sub>10</sub> H <sub>14</sub> N <sub>5</sub> NaO <sub>10</sub> P <sub>2</sub>	Adenosine 5'-diphosphate monosodium salt	23	C <sub>10</sub> H <sub>15</sub> N <sub>5</sub> O <sub>13</sub> P <sub>3</sub> ·xNa	Adenosine 5'-triphosphate trisodium salt	27
C <sub>10</sub> H <sub>14</sub> N <sub>2</sub> Na <sub>2</sub> O <sub>11</sub> P <sub>2</sub>	Thymidine-3',5'-diphosphate disodium salt	362	C <sub>10</sub> H <sub>15</sub> N <sub>5</sub> O <sub>14</sub> P <sub>3</sub> Br·xNa	8-Bromoguanosine-5'-triphosphate sodium salt - 10 mM aqueous solution	127
C <sub>10</sub> H <sub>14</sub> ClFN <sub>5</sub> O <sub>12</sub> P <sub>3</sub>	Clofarabine 5'-triphosphate triethylammonium salt	154	C <sub>10</sub> H <sub>15</sub> N <sub>4</sub> O <sub>15</sub> P <sub>3</sub>	Xanthosine-5'-triphosphate triethylammonium salt - 100 mM aqueous solution	384
C <sub>10</sub> H <sub>14</sub> N <sub>5</sub> O <sub>12</sub> P <sub>3</sub> ·Na <sub>2</sub>	2'-Deoxyadenosine-5'-triphosphate disodium salt	172	C <sub>10</sub> H <sub>16</sub> N <sub>4</sub> O <sub>3</sub>	3'-Amino-2',3'-dideoxy-5'-methylcytidine aqueous solution	51
C <sub>10</sub> H <sub>14</sub> MgN <sub>5</sub> O <sub>13</sub> P <sub>3</sub>	Adenosine 5'-triphosphate magnesium salt	27	C <sub>10</sub> H <sub>16</sub> N <sub>2</sub> O <sub>5</sub>	5,6-Dihydrothymidine	248
C <sub>10</sub> H <sub>14</sub> N <sub>5</sub> Na <sub>2</sub> O <sub>13</sub> P <sub>3</sub>	Adenosine 5'-triphosphate disodium salt hydrate	26	C <sub>10</sub> H <sub>16</sub> N <sub>3</sub> O <sub>5</sub> P	5-Methylcytidine-5'-monophosphate	313
C <sub>10</sub> H <sub>14</sub> N <sub>5</sub> O <sub>14</sub> P <sub>3</sub> Na <sub>2</sub>	Guanosine 5'-triphosphate disodium salt	285	C <sub>10</sub> H <sub>14</sub> N <sub>5</sub> O <sub>7</sub> P·H <sub>2</sub> O	Adenosine 5'-monophosphate monohydrate	24
C <sub>10</sub> H <sub>14</sub> N <sub>2</sub> O <sub>14</sub> P <sub>3</sub> Na <sub>3</sub>	5'-DTP Na <sub>3</sub>	266	C <sub>10</sub> H <sub>16</sub> N <sub>2</sub> O <sub>10</sub> P <sub>2</sub>	2'-Deoxyuridine-5'-[(a,b)-methylene]diphosphate sodium salt - 10mM aqueous solution	224
C <sub>10</sub> H <sub>14</sub> N <sub>2</sub> O <sub>14</sub> P <sub>3</sub> ·3Na	Thymidine-5'-triphosphate trisodium salt	365	C <sub>10</sub> H <sub>16</sub> N <sub>2</sub> O <sub>11</sub> P <sub>2</sub> ·xNa	Thymidine-3',5'-diphosphate sodium salt	363
C <sub>10</sub> H <sub>14</sub> N <sub>5</sub> O <sub>14</sub> P <sub>3</sub> ·Li <sub>4</sub>	3'-O-Methylcytidine 5'-triphosphate lithium salt	314	C <sub>10</sub> H <sub>16</sub> N <sub>5</sub> O <sub>11</sub> P <sub>3</sub> ·xLi	2',3'-Dideoxyadenosine-5'-triphosphate lithium salt	239
C <sub>10</sub> H <sub>15</sub> N <sub>7</sub> O <sub>2</sub>	3',5'-Diamino-3',5'-dideoxyadenosine	231		2',3'-Dideoxyguanosine-5'-O-(1-thiotriphosphate)	243
	2,6-Diamino-9-(3'-amino-2',3'-dideoxy-b-D-ribofuranosyl)purine	230		2'-Deoxyadenosine-5'-O-(1-thiotriphosphate) lithium salt - 100 mM aqueous solution	172
	3'-Amino-2',3'-dideoxy-2,6-diaminopurine riboside	50	C <sub>10</sub> H <sub>16</sub> N <sub>5</sub> O <sub>12</sub> P <sub>3</sub>	dATP - 100 mmol solution	163
C <sub>10</sub> H <sub>15</sub> N <sub>3</sub> O <sub>2</sub> S	4-(Isobutylamino)-2-(Methylthio)Pyrimidine-5-Carboxylic Acid	295	C <sub>10</sub> H <sub>16</sub> N <sub>5</sub> O <sub>12</sub> P <sub>3</sub>	2',3'-Dideoxyguanosine-5'-triphosphate lithium salt - 100mM aqueous solution	243
C <sub>10</sub> H <sub>15</sub> N <sub>3</sub> O <sub>3</sub>	2',3'-Dideoxy-5'-methylcytidine	245	C <sub>10</sub> H <sub>16</sub> N <sub>5</sub> O <sub>12</sub> P <sub>3</sub> ·xLi	2'-Deoxyguanosine-5'-O-(1-thiotriphosphate) lithium salt - 100mM aqueous solution	206
C <sub>10</sub> H <sub>15</sub> N <sub>7</sub> O <sub>3</sub>	2,6-Diamino-9-(2'-amino-2'-deoxy-b-D-ribofuranosyl)purine	230		Adenosine-5'-O-(1-thiotriphosphate) lithium salt - 100 mM aqueous solution	26
C <sub>10</sub> H <sub>15</sub> N <sub>3</sub> O <sub>4</sub>	2'-Deoxy-5'-methylisocytidine	216	C <sub>10</sub> H <sub>16</sub> N <sub>5</sub> O <sub>13</sub> P <sub>3</sub>	2'-Deoxyguanosine-5'-triphosphate sodium salt - 100mmol solution	206
	3'-Deoxy-3'-C-methylcytidine	215		3'-Azido-2',3'-dideoxythymidine-5'-triphosphate lithium salt - 100 mM aqueous solution	91
	2'-Deoxy-N4-methylcytidine	214		3'-Azido-3'-deoxythymidine-5'-triphosphate lithium salt - 100mM aqueous solution	87
	2'-Deoxy-5'-methylcytidine	214	C <sub>10</sub> H <sub>16</sub> N <sub>5</sub> O <sub>13</sub> P <sub>3</sub>	2-Amino-9-(b-D-ribofuranosyl)purine 5'-O-triphosphate - 10mM aq. solution	62
	Carbodiene	136	C <sub>10</sub> H <sub>16</sub> N <sub>5</sub> O <sub>13</sub> P <sub>3</sub> S	6-Thioguanosine-5'-O-triphosphate sodium salt	359
	5'-Amino-5'-deoxythymidine	49	C <sub>10</sub> H <sub>12</sub> Li <sub>4</sub> N <sub>5</sub> O <sub>13</sub> P <sub>3</sub> S	Guanosine 5'-[γ-thio]triphosphate tetralithium salt	286
	3'-Amino-3'-deoxythymidine	49	C <sub>10</sub> H <sub>16</sub> N <sub>5</sub> O <sub>13</sub> P <sub>3</sub> S·4Li	Guanosine 5'-O-(1-thiotriphosphate) lithium salt - 100mM aqueous solution	285
	4-Amino-5-(2'-deoxy-b-D-ribofuranosyl)-1-methyl-2(1H)-pyrimidinone	48	C <sub>10</sub> H <sub>16</sub> FN <sub>2</sub> O <sub>14</sub> P <sub>3</sub>	2'-Deoxy-2'-fluoro-2'-C-methyluridine 5'-triphosphate sodium salt	200
C <sub>10</sub> H <sub>15</sub> N <sub>7</sub> O <sub>4</sub>	5'-Hydrazino-5'-deoxyguanosine	288	C <sub>10</sub> H <sub>16</sub> N <sub>5</sub> O <sub>14</sub> P <sub>3</sub>	Guanosine 5'-triphosphate	285
	2-Hydrazinoadenosine	288		4-Azidothymidine 5-triphosphate	92
C <sub>10</sub> H <sub>15</sub> N <sub>3</sub> O <sub>5</sub>	N4-Methylcytidine	316	C <sub>10</sub> H <sub>16</sub> N <sub>5</sub> O <sub>14</sub> P <sub>3</sub> ·xNa	Guanosine 5'-triphosphate sodium salt hydrate	285
	N3-Methylcytidine	315	C <sub>10</sub> H <sub>16</sub> NO <sub>15</sub> P <sub>3</sub> ·xNa	3-Deazaridine-5'-triphosphate sodium salt	170
	5-Methylcytidine	315	C <sub>10</sub> H <sub>17</sub> NO <sub>7</sub>	5,6-Dihydro-5-azacytidine acetate	247
	3'-O-Methylcytidine	315	C <sub>10</sub> H <sub>17</sub> N <sub>3</sub> O <sub>11</sub> P <sub>2</sub>	2'-C-Methylcytidine 5'-diphosphate triethylammonium salt	313
	2'-O-Methylcytidine	315		3'-Amino-2',3'-dideoxyadenosine-5'-triphosphate lithium salt - 100 mM aqueous solution	50
	2'-C-Methylcytidine	315	C <sub>10</sub> H <sub>17</sub> ClN <sub>5</sub> O <sub>12</sub> P <sub>3</sub>	2-Amino-6-chloro-9-(2'-deoxy-b-D-ribofuranosyl)purine-5'-triphosphate	41
	5-Hydroxymethyl-2'-deoxycytidine	290			
	3'-O-Aminothymidine	63			
C <sub>10</sub> H <sub>13</sub> N <sub>5</sub> O <sub>4</sub> ·H <sub>2</sub> O	2'-Deoxyguanosine monohydrate	205			
C <sub>10</sub> H <sub>13</sub> N <sub>5</sub> O <sub>4</sub> S·xH <sub>2</sub> O	6-Thioguanosine	360			
C <sub>10</sub> H <sub>15</sub> N <sub>3</sub> O <sub>5</sub>	5-Hydroxymethylcytidine	289			
C <sub>10</sub> H <sub>13</sub> N <sub>5</sub> O <sub>5</sub> ·H <sub>2</sub> O	Isoguanosine hydrate	298			
	Guanosine	286			
C <sub>10</sub> H <sub>15</sub> N <sub>2</sub> O <sub>6</sub> P	Thymidine-5'-monophosphate	364			
C <sub>10</sub> H <sub>15</sub> N <sub>5</sub> O <sub>10</sub> P <sub>2</sub>	Adenosine 5'-diphosphate	24			
C <sub>10</sub> H <sub>15</sub> N <sub>5</sub> O <sub>10</sub> P <sub>2</sub> ·2Na	Adenosine 3',5'-diphosphate disodium salt	23			
C <sub>10</sub> H <sub>15</sub> N <sub>5</sub> O <sub>10</sub> P <sub>2</sub> S	6-Thioguanosine-5'-O-diphosphate	359			
C <sub>10</sub> H <sub>11</sub> Li <sub>4</sub> N <sub>5</sub> O <sub>11</sub> P <sub>2</sub>	Guanosine 3',5'-diphosphate tetralithium salt	283			
C <sub>10</sub> H <sub>15</sub> N <sub>5</sub> O <sub>11</sub> P <sub>2</sub> ·xNa	Guanosine 5'-diphosphate sodium salt	283			
C <sub>10</sub> H <sub>15</sub> N <sub>6</sub> O <sub>11</sub> P <sub>2</sub> ·xLi	3'-Azido-2',3'-dideoxyadenosine-5'-triphosphate lithium salt - 100 mM aqueous solution	89			

Formula	Product Name	Page
C <sub>10</sub> H <sub>17</sub> N <sub>6</sub> O <sub>12</sub> P <sub>3</sub> ·xLi	3'-Amino-2',3'-dideoxyguanosine-5'-triphosphate lithium salt - 100 mM aqueous solution	51
C <sub>10</sub> H <sub>17</sub> N <sub>6</sub> O <sub>12</sub> P <sub>3</sub>	3'-O-Amino-2'-deoxyadenosine 5'-triphosphate	44
C <sub>10</sub> H <sub>17</sub> N <sub>6</sub> O <sub>12</sub> P <sub>3</sub>	2'-Amino-2'-deoxyadenosine-5'-triphosphate	44
C <sub>10</sub> H <sub>17</sub> N <sub>2</sub> O <sub>13</sub> P <sub>3</sub>	2'-Deoxyuridine-5'-[(a,b)-methylene]triphosphate sodium salt - 10 mM aqueous solution	224
C <sub>10</sub> H <sub>17</sub> N <sub>2</sub> O <sub>13</sub> P <sub>3</sub> ·xLi	3'-Deoxythymidine-5'-triphosphate lithium salt - 100mM aqueous solution	222
C <sub>10</sub> H <sub>17</sub> N <sub>2</sub> O <sub>13</sub> P <sub>3</sub>	2'-Deoxy-2'-fluoro-5-methylcytidine 5'-triphosphate	199
C <sub>10</sub> H <sub>17</sub> N <sub>6</sub> O <sub>13</sub> P <sub>3</sub>	8-Aminoadenosine-5'-triphosphate sodium salt - 10mM aqueous solution	33
	8-Aminoadenosine-5'-triphosphate lithium salt - 100mM aqueous solution	33
C <sub>10</sub> H <sub>17</sub> N <sub>6</sub> O <sub>13</sub> P <sub>3</sub> ·xNa	Guanosine-5'-[(b,gamma)-imido]triphosphate sodium salt	284
C <sub>10</sub> H <sub>17</sub> N <sub>6</sub> O <sub>13</sub> P <sub>3</sub> Li <sub>4</sub>	2'-Amino-2'-deoxyguanosine-5'-triphosphate tetralithium salt	46
C <sub>10</sub> H <sub>17</sub> N <sub>2</sub> O <sub>13</sub> P <sub>3</sub> S·xLi	Thymidine-5'-O-(1-thiotriphosphate) lithium salt - 100mM aqueous solution	364
C <sub>10</sub> H <sub>17</sub> N <sub>2</sub> O <sub>14</sub> P <sub>3</sub> ·xLi	Thymidine 5'-triphosphate lithium salt - 100mM aqueous solution	364
C <sub>10</sub> H <sub>17</sub> N <sub>2</sub> O <sub>14</sub> P <sub>3</sub> ·xNa	Thymidine-5'-triphosphate sodium salt - 100mM aqueous solution	365
C <sub>10</sub> H <sub>15</sub> N <sub>5</sub> O <sub>13</sub> P <sub>2</sub> S·xLi·yH <sub>2</sub> O	3'-Phosphoadenosine-5'-phosphosulfate lithium salt hydrate	340
C <sub>10</sub> H <sub>17</sub> N <sub>3</sub> O <sub>15</sub> P <sub>3</sub> ·xLi	2'-O-Methyluridine-5'-triphosphate lithium salt - 100mM aqueous solution	326
C <sub>10</sub> H <sub>17</sub> N <sub>2</sub> O <sub>15</sub> P <sub>3</sub> ·xNa	2'-O-Methyluridine-5'-triphosphate sodium salt - 100mM aqueous solution	327
C <sub>10</sub> H <sub>17</sub> N <sub>5</sub> O <sub>17</sub> P <sub>4</sub> ·xLi	Guanosine 3',5'-bisdiphosphate lithium salt - 100mM aqueous solution	282
C <sub>10</sub> H <sub>17</sub> N <sub>3</sub> O <sub>4</sub> ·HI	2'-Deoxy-N3-methylcytidine hydroiodide salt	214
C <sub>10</sub> H <sub>18</sub> N <sub>3</sub> O <sub>13</sub> P <sub>3</sub>	2'-Deoxy-5-methylcytidine-5'-triphosphate sodium salt - 10 mM aqueous solution	214
	2'-Deoxy-N4-methylcytidine 5'-triphosphate lithium salt - 100 mM aqueous solution	214
	3'-Amino-2',3'-dideoxythymidine-5'-triphosphate lithium salt - 100 mM aqueous solution	52
C <sub>10</sub> H <sub>18</sub> N <sub>3</sub> O <sub>14</sub> P <sub>3</sub> ·xLi	2'-O-Methylguanosine 5'-triphosphate lithium salt - 100mM aqueous solution	317
C <sub>10</sub> H <sub>18</sub> N <sub>3</sub> O <sub>14</sub> P <sub>3</sub>	N4-Methylcytidine 5'-triphosphate triethylammonium salt	315
C <sub>10</sub> H <sub>18</sub> N <sub>3</sub> O <sub>14</sub> P <sub>3</sub> ·xLi	5-Methylcytidine-5'-triphosphate lithium salt - 100 mM solution in H <sub>2</sub> O	314
	2'-O-Methylcytidine 5'-triphosphate lithium salt - 100mM aqueous solution	314
C <sub>10</sub> H <sub>18</sub> N <sub>3</sub> O <sub>14</sub> P <sub>3</sub>	2'-Deoxy-5-hydroxymethylcytidine-5'-triphosphate lithium salt - 100 mM aqueous solution	207
C <sub>10</sub> H <sub>18</sub> N <sub>3</sub> O <sub>14</sub> P <sub>3</sub> ·Na	2'-O-Methylguanosine-5'-triphosphate sodium salt - 100mM aqueous solution	318
C <sub>10</sub> H <sub>18</sub> N <sub>3</sub> O <sub>14</sub> P <sub>3</sub> ·xNa	5-Methylcytidine-5'-triphosphate sodium salt - 100mM aqueous solution	314
	2'-O-Methylcytidine-5'-triphosphate sodium salt - 100mM aqueous solution	314
C <sub>10</sub> H <sub>12</sub> H <sub>2</sub> O <sub>4</sub>	2-Azidoadenosine	80
C <sub>11</sub> H <sub>8</sub> F <sub>3</sub> N <sub>3</sub>	2-Amino-4-phenyl-6-(trifluoromethyl)pyrimidine	60
C <sub>11</sub> H <sub>10</sub> N <sub>2</sub>	N-Phenylpyridin-4-amine	340
C <sub>11</sub> H <sub>10</sub> ClN <sub>3</sub>	2-Aminoperimidine hydrochloride	60
C <sub>11</sub> H <sub>10</sub> N <sub>2</sub> S	4-Methyl-6-phenyl-pyrimidine-2-thiol	322
C <sub>11</sub> H <sub>10</sub> N <sub>2</sub> OS	4-(4-Methoxyphenyl)-2-pyrimidinethiol	308
C <sub>11</sub> H <sub>10</sub> N <sub>2</sub> OS	6-Benzyl-2-thiouracil	118
C <sub>11</sub> H <sub>11</sub> N <sub>3</sub> O <sub>4</sub>	5-Ethynyl-1-(b-D-ribofuranosyl)-imidazo-4-carbonitrile	272
C <sub>11</sub> H <sub>11</sub> N <sub>3</sub> O <sub>6</sub>	7-Deaza-2'-C-methylinosine	169
C <sub>11</sub> H <sub>12</sub> ClN <sub>3</sub> O <sub>4</sub>	6-Chloro-7-deaza-9-(b-D-ribofuranosyl)purine	141
C <sub>11</sub> H <sub>12</sub> N <sub>2</sub> O <sub>5</sub>	5-Fluoro-1-(2',3'-dideoxy-2',3'-didehydro-5'-O-acetyl-b-L-ribofuranosyl)-uracil	277
	5-Ethynyl-2'-deoxyuridine	272
C <sub>11</sub> H <sub>12</sub> N <sub>2</sub> O <sub>6</sub>	5-Ethynyluridine	273
C <sub>11</sub> H <sub>12</sub> N <sub>2</sub> O <sub>7</sub>	2,2'-Anhydro-6-methoxycarbonyl-b-D-arabinofuranosyl uracil	68

Formula	Product Name	Page
C <sub>11</sub> H <sub>13</sub> Cl <sub>2</sub> N <sub>6</sub> O	(1S,4R)-4-(2-Amino-6-chloro-9H-purin-9-yl)-2-cyclopentene-1-methanol hydrochloride	42
C <sub>11</sub> H <sub>13</sub> IN <sub>4</sub> O <sub>2</sub>	7-Deaza-2',3'-dideoxy-7-iodoadenosine	168
C <sub>11</sub> H <sub>13</sub> N <sub>5</sub> O <sub>2</sub>	Carbovir	136
C <sub>11</sub> H <sub>13</sub> ClN <sub>4</sub> O <sub>3</sub>	7-Deaza-4-Cl-2'-deoxyguanosine	165
C <sub>11</sub> H <sub>13</sub> N <sub>4</sub> O <sub>3</sub> Li	7-Deaza-2',3'-dideoxy-7-iodoguanosine	168
C <sub>11</sub> H <sub>13</sub> IN <sub>4</sub> O <sub>3</sub>	7-Deaza-2'-deoxy-7-iodoadenosine	167
C <sub>11</sub> H <sub>13</sub> N <sub>5</sub> O <sub>3</sub>	2'-Deoxy-2'-methyleneadenosine	215
C <sub>11</sub> H <sub>13</sub> N <sub>3</sub> O <sub>4</sub>	N4-Etheno 2'-deoxycytidine	270
	7-Deaza-2'-deoxyinosine	166
C <sub>11</sub> H <sub>13</sub> ClN <sub>4</sub> O <sub>4</sub>	6-Chloro-9-(2-C-methyl-beta-D-ribofuranosyl)-9H-purine	150
	2-Chloro-3-deazaadenosine	141
C <sub>11</sub> H <sub>13</sub> IN <sub>4</sub> O <sub>4</sub>	7-Deaza-7-iodoadenosine	169
	7-Deaza-2'-deoxy-7-iodoguanosine	167
C <sub>11</sub> H <sub>13</sub> NO <sub>5</sub>	4',5'-Didehydro-5'-deoxy-2'-O-methyluridine	238
C <sub>11</sub> H <sub>13</sub> BrN <sub>2</sub> O <sub>5</sub>	5-(E)-(2-Bromovinyl)-2'-deoxyuridine	129
C <sub>11</sub> H <sub>13</sub> N <sub>2</sub> O <sub>5</sub> D <sub>3</sub>	5'-O-Methyl-D3-thymidine	326
C <sub>11</sub> H <sub>13</sub> N <sub>3</sub> O <sub>5</sub>	N4-Ethenocytidine	269
	7-Deaza-2'-deoxyxanthosine	167
C <sub>11</sub> H <sub>13</sub> F <sub>2</sub> N <sub>3</sub> O <sub>5</sub>	5'-O-Acetyl-2'-deoxy-2',2'-difluorocytidine	14
C <sub>11</sub> H <sub>13</sub> ClN <sub>4</sub> O <sub>5</sub>	2-Chloro-6-O-methylinosine	149
C <sub>11</sub> H <sub>13</sub> N <sub>5</sub> O <sub>5</sub>	1-(2'-O-4-C-Methylene-b-D-ribofuranosyl)guanine	317
	N6-Formyl-adenosine	280
C <sub>11</sub> H <sub>13</sub> NO <sub>6</sub>	Nicotinic acid riboside	335
C <sub>11</sub> H <sub>13</sub> N <sub>5</sub> O <sub>7</sub> P·Na	N2-Methylguanosine-3',5'-cyclic monophosphate	317
C <sub>11</sub> H <sub>14</sub> N <sub>2</sub> O	2-Cyclohexyl-5-pyrimidinecarbaldehyde	158
C <sub>11</sub> H <sub>14</sub> N <sub>4</sub> O <sub>2</sub>	7-Deaza-2',3'-dideoxyadenosine	167
C <sub>11</sub> H <sub>14</sub> N <sub>4</sub> O <sub>3</sub>	6-Methylpurine-2'-deoxyriboside	323
	7-Deaza-2',3'-dideoxyguanosine	168
	7-Deaza-2'-deoxyadenosine	165
	3-Deaza-2'-Deoxyadenosine	165
C <sub>11</sub> H <sub>14</sub> FN <sub>3</sub> O <sub>4</sub>	5'-O-Acetyl-2',3'-dideoxy-3'-fluoro-cytidine	17
C <sub>11</sub> H <sub>14</sub> N <sub>4</sub> O <sub>4</sub>	9-(2-C-Methyl-b-D-ribofuranosyl)purine	323
	7-Deaza-2'-deoxyguanosine	166
	7-Deazaadenosine	164
	3-Deazaadenosine	164
	Carbocyclic inosine	136
C <sub>11</sub> H <sub>14</sub> FN <sub>4</sub> O <sub>4</sub>	7-Deaza-2'-deoxy-2'-fluoroguanosine	166
C <sub>11</sub> H <sub>14</sub> FN <sub>5</sub> O <sub>4</sub>	3'-Deoxy-3'-fluoro-2'-C-methylguanosine	200
C <sub>11</sub> H <sub>14</sub> N <sub>4</sub> O <sub>4</sub> S	6-Methylmercapto-9-(b-D-ribofuranosyl)purine	320
C <sub>11</sub> H <sub>14</sub> FN <sub>2</sub> O <sub>5</sub>	N4-Acetyl-2'-deoxy-2'-fluorocytidine	16
C <sub>11</sub> H <sub>14</sub> N <sub>4</sub> O <sub>5</sub>	3'-O-Methylinosine	319
	2'-O-Methylinosine	319
	2'-C-Methylinosine	319
	9-Deazaguanosine	168
	7-Deazaguanosine	168
	3-Deazaguanosine	168
C <sub>11</sub> H <sub>14</sub> N <sub>5</sub> O <sub>7</sub> P·Na <sub>2</sub>	N6-Methyladenosine-5'-monophosphate sodium salt	309
C <sub>11</sub> H <sub>14</sub> N <sub>5</sub> O <sub>13</sub> P <sub>3</sub> Li <sub>4</sub>	3'-O-Methyladenosine 5'-triphosphate lithium salt	309
C <sub>11</sub> H <sub>14</sub> N <sub>5</sub> O <sub>14</sub> P <sub>3</sub> Li <sub>4</sub>	3'-O-Methylguanosine 5'-triphosphate lithium salt	318
C <sub>11</sub> H <sub>15</sub> N <sub>5</sub> O <sub>3</sub>	3'-Deoxy-2'-O-methyladenosine	213
	2'-Deoxy-N6-methyladenosine	213
	Carbocyclic 2'-deoxyguanosine	136
	Carbocyclic adenosine	135
C <sub>11</sub> H <sub>15</sub> N <sub>5</sub> O <sub>3</sub> S	2'-Deoxy-6-methylthioguanosine	216
	5'-Deoxy-5'-(methylthio)adenosine	216
C <sub>11</sub> H <sub>15</sub> N <sub>5</sub> O <sub>4</sub>	N6-Methyladenosine	311
	N1-Methyladenosine	311
	C2-Methyladenosine	310
	8-Methyladenosine	310
	3'-O-Methyladenosine	310
	2'-O-Methyladenosine	310
	2'-C-Methyladenosine	310
	3'-Deoxy-3'-methylguanosine	215
	2'-Deoxy-N2-methylguanosine	215
	2'-Deoxy-6-O-methyl-guanosine	215
	2'-Deoxy-2'-methoxyadenosine	213
C <sub>11</sub> H <sub>15</sub> N <sub>2</sub> O <sub>6</sub>	6-Amino-9-(1-deoxy-b-D-psicofuranosyl)purine	48
C <sub>11</sub> H <sub>15</sub> N <sub>5</sub> O <sub>6</sub> S	7-Methyl-6-thioguanosine inner salt	325
	6-Methyl-thio-guanosine	325
	2-Methylthioadenosine	324

# Formula Index

C<sub>12</sub>H<sub>16</sub>N<sub>2</sub>O<sub>6</sub>

Formula	Product Name	Page
C <sub>11</sub> H <sub>15</sub> BrN <sub>2</sub> O <sub>5</sub>	Nicotinamide riboside bromide	334
C <sub>11</sub> H <sub>15</sub> N <sub>2</sub> O <sub>5</sub> Cl	b-Nicotinamide riboside chloride	334
C <sub>11</sub> H <sub>15</sub> FN <sub>2</sub> O <sub>5</sub>	1-(2'-Deoxy-2'-fluoro-b-D-arabinofuranosyl)-5-ethyluracil	193
C <sub>11</sub> H <sub>15</sub> N <sub>3</sub> O <sub>5</sub>	6-(b-D-2-Deoxyribofuranosyl)-3,4-dihydro-8H-pyrimido[4,5-c][1,2]oxazin-7-one	220
	N4-Acetyl-2'-deoxycytidine	13
	3'-O-Acetyl-2'-deoxycytidine	13
C <sub>11</sub> H <sub>15</sub> N <sub>5</sub> O <sub>5</sub>	Nelarabine	331
	O6-Methylguanosine	319
	N7-Methylguanosine	319
	N2-Methylguanosine	319
	N1-Methylguanosine	319
	3'-O-Methylguanosine	318
	2'-O-Methylguanosine	318
	2'-C-Methylguanosine	318
C <sub>11</sub> H <sub>15</sub> NO <sub>6</sub>	3-Deaza-3'-O-methyluridine	169
	3-Deaza-2'-O-methyluridine	169
C <sub>11</sub> H <sub>15</sub> N <sub>3</sub> O <sub>6</sub>	N4-Acetylcytidine	13
C <sub>11</sub> H <sub>15</sub> N <sub>2</sub> O <sub>5</sub> P	b-Nicotinamide mononucleotide	334
C <sub>11</sub> H <sub>15</sub> N <sub>3</sub> Na <sub>3</sub> O <sub>12</sub> P <sub>3</sub>	2'-Deoxy-N6-methyladenosine 5'-triphosphate sodium salt	213
C <sub>11</sub> H <sub>15</sub> N <sub>2</sub> O <sub>15</sub> P <sub>3</sub>	5-Ethynyluridine-5'-triphosphate sodium salt - 100mM aqueous solution	273
C <sub>10</sub> H <sub>15</sub> N <sub>3</sub> O <sub>7</sub> HCl	2'-Deoxy-5-methylcytidine HCl	213
C <sub>11</sub> H <sub>16</sub> ClN <sub>3</sub> O <sub>4</sub>	2-Amino-6-chloro-7-methyl-9-(b-D-ribofuranosyl)purine	41
C <sub>11</sub> H <sub>15</sub> N <sub>5</sub> O <sub>4</sub> HI	N1-Methyladenosine hydroiodide	308
C <sub>11</sub> H <sub>16</sub> N <sub>6</sub> O <sub>4</sub>	2-Methylaminoadenosine	311
	2,6-Diamino-9-(3'-O-methyl-b-D-ribofuranosyl)purine	232
	2,6-Diamino-9-(2'-O-methyl-b-D-ribofuranosyl)purine	231
	2-Amino-2'-O-methyladenosine	58
C <sub>11</sub> H <sub>16</sub> N <sub>2</sub> O <sub>5</sub>	N3-Methylthymidine	326
	5'-O-Methylthymidine	326
	2'-Deoxy-5-ethyluridine	190
C <sub>10</sub> H <sub>15</sub> N <sub>3</sub> O <sub>5</sub> HCl	5-Methylcytidine HCl	313
C <sub>11</sub> H <sub>16</sub> N <sub>2</sub> O <sub>6</sub>	2'-O-Methyl-5-methyluridine	321
	5-Methoxymethyl-2'-deoxyuridine	307
C <sub>11</sub> H <sub>16</sub> N <sub>6</sub> O <sub>5</sub> P	Carbocyclic 2'-deoxyguanosine 5'-triphosphate	136
C <sub>11</sub> H <sub>16</sub> N <sub>2</sub> O <sub>7</sub>	1-(a-D-Mannopyranosyl)thymine	304
C <sub>11</sub> H <sub>16</sub> N <sub>5</sub> O <sub>7</sub> P	2'-O-Methyladenosine 5'-monophosphate	309
C <sub>11</sub> H <sub>16</sub> N <sub>5</sub> O <sub>7</sub> PS	2-Methylthioadenosine 5'-monophosphate	324
C <sub>11</sub> H <sub>16</sub> N <sub>5</sub> O <sub>8</sub> P	2'-O-Methylguanosine 5'-monophosphate	317
C <sub>11</sub> H <sub>16</sub> Cl <sub>2</sub> N <sub>5</sub> O <sub>12</sub> P <sub>3</sub>	5'-Adenylic acid monoanhydride with (dichlorophosphonomethyl)phosphonic acid	29
C <sub>11</sub> H <sub>17</sub> N <sub>3</sub> O <sub>5</sub>	3'-O-Methyl-5-methylcytidine	320
	2'-O-Methyl-5-methylcytidine	320
C <sub>11</sub> H <sub>17</sub> N <sub>5</sub> O <sub>10</sub> P <sub>2</sub> ·xNa	a,b-Methyleneguanosine 5'-diphosphate sodium salt	316
C <sub>11</sub> H <sub>17</sub> N <sub>4</sub> O <sub>13</sub> P <sub>3</sub>	2'-Deoxy-7-deazaisoguanosine triphosphate	177
C <sub>11</sub> H <sub>17</sub> N <sub>4</sub> O <sub>13</sub> P <sub>3</sub> ·xLi	7-Deaza-2'-deoxyguanosine-5'-triphosphate lithium salt - 100mM aqueous solution	166
C <sub>11</sub> H <sub>17</sub> N <sub>4</sub> O <sub>13</sub> P <sub>3</sub> ·xNa	7-Deaza-2'-deoxyguanosine-5'-triphosphate sodium salt - 10mM aqueous solution	166
C <sub>11</sub> H <sub>17</sub> N <sub>4</sub> O <sub>13</sub> P <sub>3</sub> S	6-Methylthioinosine-5'-triphosphate sodium salt - 10 mM aqueous solution	325
C <sub>11</sub> H <sub>18</sub> Na <sub>2</sub> N <sub>4</sub> O <sub>11</sub> P <sub>2</sub>	Cytidine 5'-diphosphate ethanolamine disodium salt	160
C <sub>11</sub> H <sub>18</sub> N <sub>5</sub> O <sub>11</sub> P <sub>3</sub> ·xNa	2'-Deoxyadenosine-5'-[(a,b)-methylene]triphosphate sodium salt - 10 mM aqueous solution	171
C <sub>11</sub> H <sub>18</sub> N <sub>5</sub> O <sub>13</sub> P <sub>3</sub>	N6-Methyladenosine-5'-triphosphate sodium salt - 10 mM aqueous solution	309
C <sub>11</sub> H <sub>18</sub> N <sub>5</sub> O <sub>13</sub> P <sub>3</sub> ·xLi	N6-Methyladenosine-5'-triphosphate lithium salt - 100 mM aqueous solution	309
	2'-O-Methyladenosine 5'-triphosphate lithium salt - 100 mM aqueous solution	309
C <sub>11</sub> H <sub>18</sub> N <sub>5</sub> O <sub>13</sub> P <sub>3</sub> ·xNa	2'-O-Methyladenosine-5'-triphosphate sodium salt - 100mM aqueous solution	309
	Guanosine-5'-[(b,gamma)-methylene]triphosphate sodium salt	284
C <sub>11</sub> H <sub>18</sub> N <sub>5</sub> O <sub>13</sub> P <sub>3</sub> S	2-Methylthioadenosine-5'-triphosphate	324

Formula	Product Name	Page
C <sub>11</sub> H <sub>18</sub> N <sub>5</sub> O <sub>13</sub> P <sub>3</sub> S·xNa	6-Methylthioguanosine-5'-triphosphate sodium salt - 10 mM aqueous solution	325
C <sub>10</sub> H <sub>15</sub> N <sub>3</sub> O <sub>5</sub> ·CH <sub>3</sub> SO <sub>3</sub>	N3-Methylcytidine methosulfate	313
C <sub>12</sub> H <sub>9</sub> NO	3-Benzoylpyridine	112
C <sub>12</sub> H <sub>10</sub> N <sub>2</sub> O	2-(2-Methylphenyl)pyrimidine-5-carbaldehyde	321
C <sub>12</sub> H <sub>10</sub> N <sub>4</sub> O	6-Benzoyloxypurine	117
C <sub>12</sub> H <sub>10</sub> Cl <sub>2</sub> N <sub>2</sub> O <sub>5</sub> P·Na	5,6-Dichloro-(1-b-D-ribofuranosyl) benzimidazole 3',5'-cyclic monophosphothioate, Sp-isomer sodium salt	237
C <sub>12</sub> H <sub>11</sub> N <sub>3</sub> OS	2-Methylsulfanyl-4-phenylamino-pyrimidine-5-carbaldehyde	324
C <sub>12</sub> H <sub>12</sub> Cl <sub>2</sub> N <sub>2</sub> O <sub>4</sub>	5,6-Dichloro-1-(b-D-ribofuranosyl) benzimidazole	237
	5,6-Dichlorobenzimidazole-1-b-D-ribofuranoside	235
C <sub>12</sub> H <sub>12</sub> N <sub>4</sub> O <sub>4</sub>	2',3'-Dideohydro-2',3'-dideoxy-5'-acetate inosine	238
C <sub>12</sub> H <sub>13</sub> N <sub>5</sub> O <sub>3</sub>	N6-Etheno 2'-deoxyadenosine	270
C <sub>12</sub> H <sub>13</sub> N <sub>5</sub> O <sub>4</sub>	N6-Ethenoadenosine	269
	2'-Deoxy-N2,3-ethenoguanosine	190
C <sub>11</sub> H <sub>13</sub> ClN <sub>4</sub> O <sub>5</sub>	6-Chloropurine-9-b-D-glucoside	151
C <sub>12</sub> H <sub>14</sub> ClN <sub>3</sub> O <sub>4</sub>	4-Chloro-7-(2-C-methyl-b-D-ribofuranosyl)-7H-pyrrolo[2,3-d]pyrimidine	150
C <sub>12</sub> H <sub>14</sub> N <sub>4</sub> O <sub>4</sub>	5'-O-Acetyl-2',3'-dideoxyinosine	17
C <sub>12</sub> H <sub>14</sub> N <sub>2</sub> O <sub>5</sub>	2'-Deoxy-5-propynyluridine	219
C <sub>12</sub> H <sub>14</sub> ClN <sub>2</sub> O <sub>5</sub>	5'-Deoxy-5'-iodo-2',3'-O-isopropylidene-5-chlorouridine	209
	5-Chloro-5'-deoxy-5'-iodo-2',3'-O-isopropylideneuridine	144
C <sub>12</sub> H <sub>14</sub> N <sub>2</sub> O <sub>6</sub>	3'-O-Propargyluridine	344
	2'-O-Propargyluridine	344
	2'-Deoxy-5-propargyloxuridine	219
C <sub>12</sub> H <sub>14</sub> N <sub>2</sub> O <sub>7</sub>	E-5-(2-Carboxyvinyl)-2'-deoxyuridine	138
C <sub>12</sub> H <sub>14</sub> N <sub>5</sub> O <sub>7</sub> P	1,N6-Ethenoadenosine-5'-monophosphate sodium salt	269
C <sub>12</sub> H <sub>15</sub> N <sub>3</sub> O <sub>4</sub>	N-Pyrrolo-2'-deoxycytidine	348
	2'-Deoxy-5-propynylcytidine	219
C <sub>12</sub> H <sub>15</sub> ClN <sub>3</sub> O <sub>4</sub>	5-Chloro-5'-deoxy-5'-iodo-2',3'-O-isopropylideneuridine	143
C <sub>12</sub> H <sub>15</sub> FIN <sub>3</sub> O <sub>4</sub>	5'-Deoxy-5-fluoro-5'-iodo-2',3'-O-isopropylideneuridine	198
C <sub>12</sub> H <sub>15</sub> ClN <sub>4</sub> O <sub>4</sub>	5-Chloro-7-(2-C-methyl-b-D-ribofuranosyl)-7H-pyrrolo[2,3-d]pyrimidin-4-amine	150
	2-Amino-4-chloro-7-(2-C-methyl-b-D-ribofuranosyl)-7H-pyrrolo[2,3-d]pyrimidine	41
C <sub>12</sub> H <sub>15</sub> N <sub>5</sub> O <sub>4</sub>	4-Amino-6-methyl-8-(2'-deoxy-b-D-ribofuranosyl)-7-pteridine	58
	N6-Acetyl-2'-deoxyadenosine	13
	3'-O-Acetyl-2'-deoxyadenosine	13
C <sub>12</sub> H <sub>15</sub> IN <sub>6</sub> O <sub>4</sub>	5-Ethylcarboxamido-2-iodoadenosine	271
C <sub>12</sub> H <sub>15</sub> N <sub>3</sub> O <sub>5</sub>	3'-O-Propargylcytidine	343
	2'-O-Propargylcytidine	343
C <sub>12</sub> H <sub>13</sub> N <sub>5</sub> O <sub>4</sub> ·H <sub>2</sub> O	Toyocamycin	369
C <sub>12</sub> H <sub>15</sub> N <sub>5</sub> O <sub>5</sub>	3-Methyl-8-(2-deoxy-b-D-ribofuranosyl)isoxanthopterin	316
	5'-O-Acetyladenosine	11
C <sub>12</sub> H <sub>15</sub> ClN <sub>2</sub> O <sub>6</sub>	5-Chloro-2',3'-O-isopropylideneuridine	149
C <sub>12</sub> H <sub>15</sub> FN <sub>2</sub> O <sub>6</sub>	3'-O-Acetyl-2'-deoxy-2'-fluoro-5-methyluridine	16
C <sub>12</sub> H <sub>15</sub> F <sub>3</sub> N <sub>2</sub> O <sub>8</sub> S	b-Nicotinamide riboside triflic acid salt	334
C <sub>12</sub> H <sub>15</sub> N <sub>5</sub> O <sub>10</sub> P <sub>2</sub>	1,N6-Ethenoadenosine-5'-diphosphate, Sodium salt	269
	5-Chloro-5'-deoxy-2',3'-O-isopropylideneuridine	144
C <sub>12</sub> H <sub>16</sub> ClN <sub>3</sub> O <sub>4</sub>	5'-Deoxy-5-fluoro-2',3'-O-isopropylideneuridine	199
C <sub>12</sub> H <sub>16</sub> N <sub>4</sub> O <sub>4</sub>	7-Deaza-2'-C-methyladenosine	169
	7-Deaza-2'-deoxy-O6-methylguanosine	167
	7-Deaza-2'-deoxy-6-methoxyguanosine	167
	2-Amino-4-methoxy-7-(2-deoxy-b-D-ribofuranosyl)-pyrrolo[2,3-d]pyrimidine	57
C <sub>12</sub> H <sub>16</sub> NeO <sub>4</sub>	5-Ethylcarboxamidoadenosine	270
	1-[2-(6-Aminopurin-9-yl)-3,4-dihydroxy-5-(hydroxymethyl)pyrrolidin-1-yl]ethanone	61
C <sub>12</sub> H <sub>16</sub> ClN <sub>3</sub> O <sub>5</sub>	5-Chloro-2',3'-O-isopropylideneuridine	148
C <sub>12</sub> H <sub>16</sub> FN <sub>3</sub> O <sub>5</sub>	5-Fluoro-2',3'-O-isopropylideneuridine	278
C <sub>12</sub> H <sub>16</sub> N <sub>4</sub> O <sub>5</sub>	7-Deaza-2'-C-methylguanosine	169
C <sub>12</sub> H <sub>16</sub> N <sub>2</sub> O <sub>6</sub>	2',3'-O-Isopropylideneuridine	300
	3'-O-Allyluridine	32
	2'-O-Allyluridine	32

Formula	Product Name	Page
C <sub>12</sub> H <sub>16</sub> N <sub>2</sub> O <sub>6</sub>	3'-O-Acetylthymidine	20
C <sub>12</sub> H <sub>16</sub> N <sub>4</sub> O <sub>6</sub>	1-(a-D-Mannopyranosyl)-6-methoxypurine	304
	5-Aza-3',5'-di-O-acetyl-2'-deoxycytidine	78
C <sub>12</sub> H <sub>16</sub> N <sub>2</sub> O <sub>7</sub>	5-Acetoxyethyl-2'-deoxyuridine	10
C <sub>12</sub> H <sub>16</sub> N <sub>2</sub> O <sub>8</sub>	5-Methoxycarbonylmethyluridine	306
C <sub>12</sub> H <sub>16</sub> N <sub>5</sub> O <sub>13</sub> P <sub>3</sub>	1,N6-Ethenoadenosine-5'-triphosphate sodium salt - 10mM aqueous solution	269
C <sub>12</sub> H <sub>15</sub> N <sub>5</sub> O <sub>5</sub> ·xH <sub>2</sub> O	Entecavir hydrate	267
C <sub>12</sub> H <sub>17</sub> N <sub>5</sub> O <sub>4</sub>	6-Dimethylamino-9-(b-D-ribofuranosyl)purine	251
C <sub>12</sub> H <sub>17</sub> N <sub>3</sub> O <sub>5</sub>	2',3'-O-Isopropylideneuridine	299
	3'-O-Allylcytidine	31
	2'-O-Allylcytidine	31
	N4-Acetyl-3'-deoxy-3'-C-methylcytidine	17
	N4-Acetyl-2'-deoxy-5-methylcytidine	17
C <sub>12</sub> H <sub>17</sub> N <sub>5</sub> O <sub>5</sub>	N2,N2-Dimethylguanosine	252
C <sub>12</sub> O <sub>9</sub> N <sub>5</sub> H <sub>17</sub>	N2,7-Dimethylguanosine	251
C <sub>12</sub> H <sub>17</sub> N <sub>3</sub> O <sub>6</sub>	1-[2,3-O-Isopropylidene-b-D-ribofuranosyl]-1,2,4-triazole-3-carboxylic acid methyl ester	300
	N4-Acetyl-2'-O-methylcytidine	19
	5-Acetoxyethyl-2'-deoxycytidine	10
C <sub>12</sub> H <sub>15</sub> N <sub>5</sub> O <sub>5</sub> ·xH <sub>2</sub> O	Sangivamycin	353
C <sub>12</sub> H <sub>17</sub> N <sub>4</sub> O <sub>13</sub> P <sub>3</sub> ·4Li	5-Aminoallyl 2'-deoxycytidine-5'-triphosphate lithium salt - 100mM aqueous solution	34
C <sub>12</sub> H <sub>18</sub> N <sub>4</sub> O <sub>4</sub>	5-Aminoallyl-2'-deoxyuridine	35
C <sub>12</sub> H <sub>18</sub> N <sub>2</sub> O <sub>5</sub>	5-Isopropyl-2'-deoxyuridine	298
	2-O-Ethylthymidine	272
C <sub>12</sub> H <sub>18</sub> N <sub>7</sub> O <sub>6</sub> P	8-(2-Aminoethyl)aminoadenosine 3',5'-cyclic monophosphate	53
C <sub>12</sub> H <sub>18</sub> N <sub>2</sub> O <sub>7</sub>	2'-O-(2-Methoxyethyl)uridine	307
C <sub>12</sub> H <sub>19</sub> FN <sub>2</sub> O <sub>5</sub> S	5-Trimethylstannyl-1-(2-deoxy-2-fluoro-b-D-arabinofuranosyl)uracil	377
C <sub>12</sub> H <sub>19</sub> FN <sub>2</sub> O <sub>5</sub> Sn	2'-Deoxy-2'-fluoro-5-(trimethylstannyl)uridine-epimer	202
C <sub>12</sub> H <sub>20</sub> N <sub>2</sub> O <sub>5</sub> Sn	5-(Trimethylstannyl)-2'-deoxyuridine	377
C <sub>12</sub> H <sub>20</sub> N <sub>3</sub> O <sub>14</sub> P <sub>3</sub>	5-Aminoallyl 2'-deoxyuridine 5'-triphosphate lithium salt - 100mM aqueous solution	34
C <sub>12</sub> H <sub>20</sub> N <sub>3</sub> O <sub>14</sub> P <sub>3</sub> ·xNa	5-Aminoallyl 2'-deoxyuridine 5'-triphosphate sodium salt - 100mM aqueous solution	35
C <sub>12</sub> H <sub>20</sub> N <sub>3</sub> O <sub>15</sub> P <sub>3</sub> ·xNa	5-Aminoallyl uridine 5'-triphosphate sodium salt - 100mM aqueous solution	35
C <sub>12</sub> H <sub>21</sub> N <sub>4</sub> O <sub>14</sub> P <sub>3</sub> ·xLi	5-Aminoallylcytidine 5'-triphosphate lithium salt - 100mM aqueous solution	33
C <sub>13</sub> H <sub>12</sub> ClFN <sub>2</sub>	2-Chloro-4-[2-(4-Fluorophenyl)Ethyl]-6-Methylpyrimidine	146
C <sub>13</sub> H <sub>13</sub> N <sub>3</sub> O <sub>2</sub> S	2-(Methylthio)-4-(P-Tolylamino)Pyrimidine-5-Carboxylic Acid	325
C <sub>13</sub> H <sub>14</sub> N <sub>4</sub> O <sub>4</sub>	7-Deaza-2'-deoxy-7-ethynyladenosine	166
C <sub>13</sub> H <sub>14</sub> N <sub>4</sub> O <sub>4</sub>	7-Deaza-2'-C-ethynyladenosine	168
C <sub>13</sub> H <sub>14</sub> N <sub>2</sub> O <sub>5</sub>	1-(2-Deoxy-b-D-ribofuranosyl)-5-nitroindole	220
C <sub>13</sub> H <sub>14</sub> ClN <sub>5</sub> O <sub>5</sub>	5'-Carboxy-2-chloro-2'-3'-O-isopropylideneadenosine	137
C <sub>13</sub> H <sub>14</sub> N <sub>5</sub> O <sub>5</sub>	5'-Carboxy-2-iodo-2',3'-O-isopropylideneadenosine	137
C <sub>13</sub> H <sub>15</sub> ClN <sub>4</sub> O <sub>4</sub>	6-Chloro-9-(2',3'-O-isopropylidene-b-D-ribofuranosyl)purine	148
C <sub>13</sub> H <sub>15</sub> N <sub>5</sub> O <sub>4</sub>	N6-Propargyladenosine	343
	3'-O-Propargyladenosine	343
	2'-O-Propargyladenosine	343
C <sub>13</sub> H <sub>15</sub> N <sub>5</sub> O <sub>5</sub>	3'-O-Propargylguanosine	344
	2'-O-Propargylguanosine	344
	5'-Carboxy-2',3'-O-isopropylideneadenosine	138
C <sub>12</sub> H <sub>15</sub> ClN <sub>4</sub> O <sub>5</sub> S	2-Methylthio-6-chloropurine riboside	324
C <sub>13</sub> H <sub>15</sub> BrN <sub>2</sub> O <sub>7</sub>	3',5'-Di-O-acetyl-5-bromo-2'-deoxyuridine	227
C <sub>13</sub> H <sub>15</sub> ClN <sub>2</sub> O <sub>7</sub>	3',5'-Di-O-acetyl-5-chloro-2'-deoxyuridine	227
C <sub>13</sub> H <sub>15</sub> FN <sub>2</sub> O <sub>7</sub>	3',5'-Di-O-acetyl-2'-deoxy-5-fluorouridine	228
	3',5'-Di-O-acetyl-2'-deoxy-2'-fluorouridine	228
C <sub>13</sub> H <sub>15</sub> N <sub>2</sub> O <sub>7</sub>	3',5'-Di-O-acetyl-2'-deoxy-5-iodouridine	228
C <sub>13</sub> H <sub>15</sub> Ba <sub>2</sub> N <sub>4</sub> O <sub>12</sub> P	N-Succinyl-5-aminoimidazole-4-carboxamide ribose 5'-phosphate dibarium salt	354
C <sub>13</sub> H <sub>16</sub> N <sub>6</sub> O <sub>3</sub>	5'-Azido-5'-deoxy-2',3'-O-isopropylideneadenosine	86
C <sub>13</sub> H <sub>16</sub> ClN <sub>5</sub> O <sub>4</sub>	2-Chloro-2',3'-O-isopropylideneadenosine	148
C <sub>13</sub> H <sub>16</sub> N <sub>6</sub> O <sub>4</sub>	2-Iodo-2',3'-O-isopropylideneadenosine	295

Formula	Product Name	Page
C <sub>13</sub> H <sub>16</sub> N <sub>6</sub> O <sub>4</sub>	Triciribine	375
	5'-(N-Cyclopropyl)carboxamidoadenosine	158
C <sub>13</sub> H <sub>16</sub> N <sub>4</sub> O <sub>4</sub> S	2',3'-O-Isopropylidene-6-thioinosine	300
C <sub>13</sub> H <sub>16</sub> N <sub>4</sub> O <sub>5</sub>	2',3'-O-Isopropylideneinosine	299
C <sub>13</sub> H <sub>16</sub> N <sub>2</sub> O <sub>8</sub>	2'-O-Methyl-5-propynyluridine	322
C <sub>13</sub> H <sub>16</sub> FN <sub>3</sub> O <sub>6</sub>	2',3'-Di-O-acetyl-5'-deoxy-5-fluorocytidine	227
C <sub>13</sub> H <sub>16</sub> N <sub>4</sub> O <sub>6</sub>	4-Amino-7-(2-C-methyl-b-D-ribofuranosyl)-7H-pyrrolo[2,3-d]pyrimidine-5-carboxylic acid	59
C <sub>13</sub> H <sub>16</sub> N <sub>2</sub> O <sub>7</sub>	5-(4-Hydroxybutyl-1-yl)uridine	289
	3',5'-Di-O-acetyl-2'-deoxy-D-uridine	228
	E-5-(2-Carbomethoxyvinyl)-2'-deoxyuridine	136
C <sub>13</sub> H <sub>16</sub> N <sub>2</sub> O <sub>8</sub>	2',3'-Di-O-acetyl-D-uridine	229
C <sub>13</sub> H <sub>16</sub> N <sub>4</sub> O <sub>9</sub> Na <sub>2</sub>	N-Succinyl-5-aminoimidazole-4-carboxamide ribose disodium salt	354
C <sub>13</sub> H <sub>17</sub> N <sub>5</sub> O <sub>4</sub>	2',3'-O-Isopropylideneadenosine	299
	2-(2-Deoxy-b-D-ribofuranosyl)-2,3,8,9-tetrahydro-7-oxa-2,3,5,6-tetraazabenz[cd]azulene-4-amine	221
	3'-Deoxy-N6-propionyladenosine	219
	4-Amino-2,6-dimethyl-8-(2'-deoxy-b-D-ribofuranosyl)-7-pteridone	53
	3'-O-Allylguanosine	31
	2'-O-Allylguanosine	31
C <sub>13</sub> H <sub>17</sub> N <sub>3</sub> O <sub>5</sub>	2'-O-Methyl-5-propynylcytidine	322
C <sub>13</sub> H <sub>17</sub> N <sub>5</sub> O <sub>5</sub>	2',3'-O-Isopropylideneadenosine	299
	3'-O-Allylguanosine	32
	2'-O-Allylguanosine	32
C <sub>13</sub> H <sub>17</sub> N <sub>3</sub> O <sub>6</sub>	3'-O, N4-Diacetyl-2'-deoxycytidine	330
C <sub>13</sub> H <sub>17</sub> N <sub>5</sub> O <sub>6</sub>	8-(Allyloxy)guanosine	32
	7-Allyl-7,8-dihydro-8-oxoguanosine	32
C <sub>13</sub> H <sub>17</sub> N <sub>6</sub> O <sub>6</sub> P	Tricyclic nucleoside phosphate	375
C <sub>13</sub> H <sub>18</sub> N <sub>6</sub> O <sub>4</sub>	2'-Deoxy-N2-DMF-guanosine	181
C <sub>13</sub> H <sub>18</sub> N <sub>6</sub> O <sub>5</sub>	N2-DMF-guanosine	254
C <sub>13</sub> H <sub>18</sub> N <sub>5</sub> O <sub>13</sub> P <sub>3</sub>	N6-Propargyladenosine-5'-triphosphate sodium salt	343
	Adenosine 5'-[(propargyl)]triphosphate sodium salt	26
C <sub>13</sub> H <sub>19</sub> N <sub>5</sub> O <sub>4</sub>	2'-Deoxy-N2-isopropylguanosine	212
C <sub>13</sub> H <sub>19</sub> N <sub>3</sub> O <sub>5</sub>	2'-Deoxy-N2-isobutyluridylyl	211
	2'-Deoxy-N2-isobutyluridylyl-a-cytidine	210
C <sub>13</sub> H <sub>19</sub> N <sub>5</sub> O <sub>5</sub>	N2,N2,7-Trimethylguanosine	376
	2'-O-(2-Methoxyethyl)adenosine	306
C <sub>13</sub> H <sub>19</sub> N <sub>5</sub> O <sub>6</sub>	2'-O-(2-Methoxyethyl)guanosine	306
C <sub>13</sub> H <sub>20</sub> N <sub>2</sub> O <sub>7</sub>	2'-O-(2-Methoxyethyl)-5-methyluridine	307
C <sub>13</sub> H <sub>21</sub> N <sub>3</sub> O <sub>6</sub>	2'-O-(2-Methoxyethyl)-5-methylcytidine	307
C <sub>13</sub> H <sub>22</sub> N <sub>3</sub> O <sub>14</sub> P <sub>3</sub>	3'-O-[(Propan-2-ylidene)amino]thymidine 5'-triphosphate	343
C <sub>14</sub> H <sub>11</sub> N	2-Methyl-6-(phenylethynyl)pyridine	321
C <sub>14</sub> H <sub>16</sub> N <sub>6</sub> O <sub>2</sub>	Abacavir carboxylate	9
C <sub>14</sub> H <sub>17</sub> NO <sub>3</sub>	1-(2-Deoxy-b-D-ribofuranosyl)-4-methylindole	220
C <sub>14</sub> H <sub>17</sub> N <sub>5</sub> O <sub>6</sub>	3',5'-Di-O-acetyl-2'-deoxyguanosine	228
	2',3'-Di-O-acetyladenosine	226
C <sub>14</sub> H <sub>17</sub> N <sub>5</sub> O <sub>6</sub>	N6-Succinyl adenosine	354
C <sub>14</sub> H <sub>17</sub> N <sub>3</sub> O <sub>9</sub>	2',3',5'-Tri-O-acetyl-6-azauridine	369
C <sub>14</sub> H <sub>18</sub> N <sub>6</sub> O	ent-abacavir	267
	Abacavir	9
C <sub>14</sub> H <sub>18</sub> FN <sub>5</sub> O <sub>5</sub>	2'-Deoxy-N2-isobutyluridylyl-2'-fluoroguanosine	211
	2'-Deoxy-2'-fluoro-N2-isobutyluridylylguanosine	198
C <sub>14</sub> H <sub>18</sub> N <sub>2</sub> O <sub>7</sub>	5'-O-Levulinoylthymidine	303
	3'-O-Levulinoylthymidine	303
C <sub>14</sub> H <sub>18</sub> N <sub>4</sub> O <sub>8</sub>	2',3',5'-Triacetyl-azacytidine	369
C <sub>14</sub> H <sub>19</sub> ClN <sub>2</sub> O	trans-Abacavir hydrochloride	9
C <sub>14</sub> H <sub>19</sub> N <sub>5</sub> O <sub>4</sub>	2',3'-Dideoxy-N2-isobutyluridylylguanosine	245
C <sub>14</sub> H <sub>19</sub> N <sub>6</sub> O <sub>4</sub> P	Abacavir 5'-phosphate	9
C <sub>14</sub> H <sub>19</sub> N <sub>5</sub> O <sub>5</sub>	2'-Deoxy-N2-isobutyluridylylguanosine	211
C <sub>14</sub> H <sub>19</sub> N <sub>5</sub> O <sub>6</sub>	N2-Isobutyluridylylguanosine	296
	N2-Isobutyluridylyl-9-(b-D-arabinofuranosyl)guanine	296
C <sub>14</sub> H <sub>20</sub> N <sub>6</sub> O <sub>4</sub>	N2-isobutyluridylyl-7-OH-Morpholino guanosine	297
C <sub>14</sub> H <sub>20</sub> N <sub>6</sub> O <sub>5</sub>	N2-DMF-2'-O-methylguanosine	254
	N2-DMF-2'-O-methylguanosine	254
C <sub>14</sub> H <sub>18</sub> N <sub>6</sub> O·½H <sub>2</sub> SO <sub>4</sub>	Abacavir sulfate	9
C <sub>14</sub> H <sub>20</sub> N <sub>6</sub> O <sub>5</sub> ·2H <sub>2</sub> O	S-(5'-Adenosyl)-L-homocysteine dihydrate	178
C <sub>14</sub> H <sub>22</sub> N <sub>4</sub> O <sub>5</sub> ·2HCl	2'-Deoxy-L-cytidine 3'-O-L-valinyl ester 2HCl	28
C <sub>14</sub> H <sub>26</sub> N <sub>4</sub> O <sub>1</sub> P <sub>2</sub> ·Na	Citicoline sodium salt	153



# Formula Index

C<sub>15</sub>H<sub>19</sub>N<sub>3</sub>O<sub>8</sub>-HCl

Formula	Product Name	Page	Formula	Product Name	Page
C <sub>14</sub> H <sub>28</sub> N <sub>4</sub> O <sub>12</sub> P <sub>2</sub>	Uridine 5'-diphosphate choline ammonium salt	380	C <sub>9</sub> H <sub>13</sub> FN <sub>2</sub> O <sub>14</sub> P <sub>3</sub> ·C <sub>6</sub> H <sub>16</sub> N	1-(2'-Deoxy-2'-fluoro-b-D-arabinofuranosyl)uracil	194
C <sub>15</sub> H <sub>14</sub> N <sub>4</sub> O	Nevirapine	331	C <sub>9</sub> H <sub>16</sub> N <sub>3</sub> O <sub>14</sub> P <sub>3</sub> ·C <sub>6</sub> H <sub>15</sub> N	5'-triphosphate triethylammonium salt	298
C <sub>15</sub> H <sub>15</sub> N <sub>5</sub> O <sub>4</sub> De	N6-Isopentenyladenosine-D6	298	C <sub>15</sub> H <sub>9</sub> CIN <sub>4</sub> S	Isocytidine triphosphate triethylamine salt	117
C <sub>15</sub> H <sub>15</sub> F <sub>4</sub> N <sub>5</sub> O <sub>6</sub> S	3',5'-Di-O-acetyl-2-fluoro-2'-O-trifluoromethanesulfonyl-adenosine	229	C <sub>16</sub> H <sub>14</sub> N <sub>2</sub> O <sub>6</sub>	2-Benzylthio-6-chloropurine	94
C <sub>15</sub> H <sub>16</sub> IN <sub>3</sub> O <sub>7</sub>	5-Iodo-1-(2',3',5'-tri-O-acetyl-b-D-ribofuranosyl)-imidazo-4-carbonitrile	295	C <sub>16</sub> H <sub>14</sub> CIN <sub>5</sub> O <sub>6</sub> PS <sub>2</sub> ·Na	5'-O-Benzoyl-2,2'-anhydrouridine	151
C <sub>15</sub> H <sub>17</sub> N <sub>5</sub> O <sub>5</sub>	Kinetin riboside	301	C <sub>16</sub> H <sub>14</sub> CIN <sub>5</sub> O <sub>7</sub> PS·Na	8-(4-Chlorophenylthio)guanosine 3',5'-cyclic monophosphate sodium salt	151
C <sub>15</sub> H <sub>18</sub> NaO <sub>5</sub>	Regadenosin	348	C <sub>16</sub> H <sub>15</sub> FN <sub>2</sub> O <sub>5</sub>	8-(4-Chlorophenylthio)guanosine 3',5'-cyclic monophosphate sodium salt	107
C <sub>15</sub> H <sub>18</sub> NaO <sub>7</sub>	5-Amino-1-(2',3',5'-tri-O-acetyl-b-D-ribofuranosyl)-imidazole-4-carbonitrile	63	C <sub>16</sub> H <sub>15</sub> N <sub>5</sub> O <sub>5</sub>	5'-O-Benzoyl-2,3'-dideoxy-3'-fluorouridine	82
C <sub>15</sub> H <sub>18</sub> N <sub>2</sub> O <sub>9</sub>	2',3',5'-Tri-O-acetyluridine	372	C <sub>16</sub> H <sub>15</sub> CIN <sub>5</sub> O <sub>6</sub> PS	3'-Azido-5'-O-benzoyl-2,3'-dideoxyuridine	151
C <sub>15</sub> H <sub>16</sub> N <sub>5</sub> Na <sub>2</sub> O <sub>8</sub> P·H <sub>2</sub> O	Kinetin riboside-5'-monophosphate sodium salt	301	C <sub>16</sub> H <sub>15</sub> Na <sub>3</sub> O <sub>13</sub> P	8-(4-Chlorophenylthio)adenosine 3',5'-cyclic monophosphate	377
C <sub>15</sub> H <sub>19</sub> CIN <sub>6</sub> O <sub>4</sub>	2-Chloro-5'-N-ethylcarboxamide-2',3'-O-isopropylidene adenosine	145	C <sub>16</sub> H <sub>16</sub> BN <sub>5</sub> O <sub>4</sub>	2',3'-O-Trinitrophenyl-adenosine-5'-monophosphate triethylammonium salt	26
C <sub>15</sub> H <sub>19</sub> N <sub>6</sub> O <sub>5</sub>	5'-Ethylcarboxamido-2-iodo-2',3'-O-isopropylideneadenosine	271	C <sub>16</sub> H <sub>16</sub> Ne <sub>6</sub> O	Adenosine 2',3'-O-phenylboronate	81
C <sub>15</sub> H <sub>19</sub> N <sub>5</sub> O <sub>5</sub>	5'-O-Acetyl-2',3'-O-isopropylideneadenosine	19	C <sub>16</sub> H <sub>16</sub> N <sub>2</sub> O <sub>5</sub>	3'-Azido-N4-benzoyl-2,3'-dideoxycytidine	115
C <sub>15</sub> H <sub>19</sub> N <sub>3</sub> O <sub>7</sub>	3',5'-Di-O-acetyl-N4-acetyl-2'-deoxycytidine	226	C <sub>16</sub> H <sub>16</sub> FN <sub>3</sub> O <sub>5</sub>	5'-O-Benzyl-2,2'-anhydrouridine	104
C <sub>15</sub> H <sub>19</sub> NaO <sub>8</sub> ·Na	N6-Carbamoylthreonyl-adenosine sodium salt	135	C <sub>16</sub> H <sub>16</sub> ClIN <sub>4</sub> O <sub>7</sub>	N4-Benzoyl-2'-deoxy-2'-fluorocytidine	104
C <sub>15</sub> H <sub>19</sub> BRN <sub>3</sub> NaO <sub>13</sub> P <sub>2</sub>	8-Bromocyclic adenosine diphosphate ribose sodium salt	123	C <sub>16</sub> H <sub>16</sub> N <sub>2</sub> O <sub>6</sub>	N4-Benzoyl-1-(2'-deoxy-2'-fluoro-b-D-arabinofuranosyl)cytosine	107
C <sub>15</sub> H <sub>20</sub> N <sub>6</sub> O <sub>4</sub>	5'-Ethylcarboxamido-2',3'-O-isopropylideneadenosine	271	C <sub>16</sub> H <sub>16</sub> Cl <sub>2</sub> N <sub>4</sub> O <sub>7</sub>	5'-O-Benzoyl-2'-deoxyuridine	238
C <sub>15</sub> H <sub>20</sub> N <sub>2</sub> O <sub>7</sub>	2'-Deoxy-3'-O-levulinoylthymidine	212	C <sub>16</sub> H <sub>16</sub> CIN <sub>4</sub> O <sub>7</sub>	2,6-Dichloro-9-(2',3',5'-tri-O-acetyl-b-D-ribofuranosyl)purine	148
C <sub>15</sub> H <sub>20</sub> N <sub>4</sub> O <sub>8</sub>	5-Amino-1-(2',3',5'-tri-O-acetyl-b-D-ribofuranosyl)-imidazole-4-carboxamide	63	C <sub>16</sub> H <sub>16</sub> Na <sub>6</sub> O <sub>16</sub> P <sub>2</sub>	6-Chloro-2-iodo-9-(2',3',5'-tri-O-acetyl-b-D-ribofuranosyl)purine	148
C <sub>15</sub> H <sub>20</sub> Na <sub>3</sub> O <sub>13</sub> P <sub>2</sub>	8-Azidocyclic adenosine diphosphate ribose	83	C <sub>16</sub> H <sub>16</sub> Na <sub>6</sub> O <sub>16</sub> P <sub>2</sub>	6-Chloro-2-iodo-9-(2',3',5'-tri-O-acetyl-b-D-ribofuranosyl)purine	377
C <sub>15</sub> H <sub>20</sub> Na <sub>4</sub> O <sub>14</sub> P <sub>2</sub>	Cyclic inosine diphosphate ribose	157	C <sub>16</sub> H <sub>17</sub> N <sub>5</sub> O <sub>4</sub> S	2',3'-O-Trinitrophenyl-adenosine-5'-diphosphate triethylammonium salt	347
C <sub>15</sub> H <sub>21</sub> N <sub>5</sub> O <sub>4</sub>	6-(3,3-Dimethylallylamino)-9-(b-D-ribofuranosyl)purine	251	C <sub>16</sub> H <sub>17</sub> N <sub>3</sub> O <sub>5</sub>	6-(2-Pyridylmethylthio)-9-(b-D-ribofuranosyl)purine	98
C <sub>15</sub> H <sub>21</sub> N <sub>5</sub> O <sub>5</sub>	N(6)-Cyclopentyladenosine	158	C <sub>16</sub> H <sub>17</sub> N <sub>3</sub> O <sub>6</sub>	N4-Benzoyl-3'-deoxycytidine	98
C <sub>15</sub> H <sub>21</sub> N <sub>5</sub> O <sub>5</sub>	Zeatin riboside	385	C <sub>16</sub> H <sub>17</sub> N <sub>3</sub> O <sub>6</sub>	N4-Benzoyl-2'-deoxycytidine	97
C <sub>15</sub> H <sub>21</sub> N <sub>5</sub> O <sub>5</sub>	trans-Zeatin riboside	385	C <sub>16</sub> H <sub>17</sub> N <sub>3</sub> O <sub>6</sub>	N4-Benzoyl-2'-deoxy-a-cytidine	96
C <sub>15</sub> H <sub>21</sub> N <sub>5</sub> O <sub>5</sub>	N6-Isobutyl-2'-O-methyladenosine	297	C <sub>16</sub> H <sub>17</sub> CIN <sub>4</sub> O <sub>7</sub>	N4-Benzoyl-L-cytidine	372
C <sub>15</sub> H <sub>21</sub> N <sub>5</sub> O <sub>6</sub>	1,5-Anhydro-2,3-dideoxy-2-(N2-isobutylguanidin-1-yl)-D-glucitol	67	C <sub>16</sub> H <sub>17</sub> CIN <sub>4</sub> O <sub>8</sub>	9-(2',3',5'-Tri-O-acetyl-b-D-ribofuranosyl)-6-chloropurine	153
C <sub>15</sub> H <sub>21</sub> N <sub>5</sub> O <sub>6</sub>	N2-Isobutyl-2'-O-methylguanosine	297	C <sub>16</sub> H <sub>17</sub> CIN <sub>4</sub> O <sub>8</sub>	6-Chloro-2-hydroxy-9-(2',3',5'-tri-O-acetyl-b-D-ribofuranosyl)purine	146
C <sub>15</sub> H <sub>21</sub> FN <sub>2</sub> O <sub>11</sub>	5-Fluorouridine-5'-O-b-D-galactopyranoside	280	C <sub>16</sub> H <sub>17</sub> N <sub>3</sub> O <sub>9</sub>	E-5-(2-Carboxyvinyl)-2'-deoxyuridine hydroxysuccinimide ester	138
C <sub>15</sub> H <sub>20</sub> CIN <sub>5</sub> O <sub>4</sub> ·½H <sub>2</sub> O	2-Chloro-N6-cyclopentyladenosine hemihydrate	140	C <sub>16</sub> H <sub>17</sub> D <sub>3</sub> Na <sub>3</sub> O <sub>10</sub>	3'-Azido-3'-deoxythymidine-methyl-D3-b-D-glucuronide sodium salt	86
C <sub>15</sub> H <sub>22</sub> Na <sub>6</sub> O <sub>5</sub> S	S-Adenosyl-L-methionine	29	C <sub>16</sub> H <sub>17</sub> N <sub>5</sub> O <sub>19</sub> P <sub>3</sub>	2',3'-O-Trinitrophenyl-adenosine-5'-triphosphate triethylammonium salt	377
C <sub>15</sub> H <sub>22</sub> FN <sub>3</sub> O <sub>6</sub>	5'-Deoxy-5-fluoro-N4-(pentylloxycarbonyl)cytidine	201	C <sub>16</sub> H <sub>18</sub> IN <sub>3</sub> O <sub>4</sub>	N4-Benzoyl-2'-deoxy-5-iodocytidine	340
C <sub>15</sub> H <sub>22</sub> FN <sub>3</sub> O <sub>6</sub>	5'-Deoxy-5-fluoro-N-[(3-methylbutoxy)carbonyl]cytidine	199	C <sub>16</sub> H <sub>18</sub> Ne <sub>6</sub> O <sub>4</sub>	2-Phenylaminoadenosine	60
C <sub>15</sub> H <sub>22</sub> FN <sub>3</sub> O <sub>6</sub>	5'-Deoxy-5-fluoro-N-[(2-methylbutoxy)carbonyl]cytidine	199	C <sub>16</sub> H <sub>18</sub> Na <sub>4</sub> O <sub>7</sub>	8-(4-Aminophenyl)-2'-deoxyguanosine	372
C <sub>15</sub> H <sub>22</sub> N <sub>5</sub> O <sub>7</sub> P	N6-Cyclopentyladenosine-5'-O-monophosphate	158	C <sub>16</sub> H <sub>18</sub> Na <sub>4</sub> O <sub>7</sub>	2',3',5'-Tri-O-acetylnebularine	370
C <sub>15</sub> H <sub>20</sub> N <sub>5</sub> Na <sub>2</sub> O <sub>7</sub> P·H <sub>2</sub> O	N6-Isopentenyladenosine-5'-monophosphate sodium salt	298	C <sub>16</sub> H <sub>18</sub> CIN <sub>5</sub> O <sub>7</sub>	2',3',5'-Tri-O-acetyl-6-chloro-6-deoxyguanosine	370
C <sub>15</sub> H <sub>20</sub> N <sub>5</sub> O <sub>9</sub> PNa <sub>2</sub> ·H <sub>2</sub> O	trans-Zeatin riboside-5'-monophosphate sodium salt	385	C <sub>16</sub> H <sub>18</sub> CIN <sub>5</sub> O <sub>7</sub>	2',3',5'-Tri-O-acetyl-2-chloroadenosine	43
C <sub>15</sub> H <sub>23</sub> Na <sub>3</sub> O <sub>5</sub>	Dihydrozeatin riboside	248	C <sub>16</sub> H <sub>18</sub> FN <sub>5</sub> O <sub>7</sub>	6-Amino-2-chloro-9-(2',3',5'-tri-O-acetyl-b-D-ribofuranosyl)purine	371
C <sub>15</sub> H <sub>23</sub> CIN <sub>6</sub> O <sub>5</sub> ·2HCl	S-(5'-Adenosyl)-L-methionine chloride dihydrochloride	28	C <sub>16</sub> H <sub>18</sub> N <sub>2</sub> O <sub>7</sub> S	2'-Deoxy-5'-O-p-toluenesulfonyluridine	223
C <sub>15</sub> H <sub>24</sub> N <sub>2</sub> O <sub>5</sub> Si	5'-O-tert-Butyldimethylsilyl-2,2'-anhydrouridine	130	C <sub>16</sub> H <sub>18</sub> Na <sub>6</sub> O	2',3',5'-Tri-O-acetylinosine	371
C <sub>15</sub> H <sub>22</sub> N <sub>5</sub> Na <sub>2</sub> O <sub>8</sub> P·H <sub>2</sub> O	Dihydrozeatin riboside-5'-monophosphate sodium salt	248	C <sub>16</sub> H <sub>18</sub> BRN <sub>5</sub> O <sub>8</sub>	2',3',5'-Tri-O-acetyl-8-bromoguanosine	369
C <sub>15</sub> H <sub>21</sub> N <sub>5</sub> O <sub>13</sub> P <sub>2</sub> ·NH <sub>3</sub>	Cyclic adenosine 5'-diphosphate ribose ammonium salt	156	C <sub>16</sub> H <sub>19</sub> N <sub>3</sub> O <sub>4</sub>	3'-Amino-5'-O-benzyl-2,3'-dideoxyuridine	368
C <sub>15</sub> H <sub>24</sub> Na <sub>5</sub> O <sub>17</sub> P <sub>3</sub>	Adenosine-5'-O-diphosphoribose phosphate	24	C <sub>16</sub> H <sub>19</sub> N <sub>3</sub> O <sub>5</sub> S	5'-Tosyl-2'-deoxy cytidine	378
C <sub>15</sub> H <sub>25</sub> FN <sub>2</sub> O <sub>4</sub> Si	5'-O-tert-Butyldimethylsilyl-2,3'-dideoxy-3'-fluorouridine	130	C <sub>16</sub> H <sub>19</sub> N <sub>5</sub> O <sub>7</sub>	3',5'-N2-Tri-O-acetyl-2'-deoxyguanosine	369
C <sub>15</sub> H <sub>25</sub> N <sub>5</sub> O <sub>4</sub> Si	3'-Azido-5'-O-tert-butylidimethylsilyl-2,3'-dideoxyuridine	83	C <sub>16</sub> H <sub>19</sub> N <sub>5</sub> O <sub>7</sub>	2',3',5'-Tri-O-acetyladenosine	369
C <sub>15</sub> H <sub>25</sub> IN <sub>2</sub> O <sub>5</sub> Si	5'-O-tert-Butyldimethylsilyl-2'-deoxy-5-iodouridine	130	C <sub>16</sub> H <sub>19</sub> N <sub>5</sub> O <sub>7</sub>	2,3,5-Tri-O-acetyl a-adenosine	63
C <sub>15</sub> H <sub>25</sub> N <sub>5</sub> O <sub>6</sub>	(2S)-2-Amino-6-((4-amino-1-[(2R,3R,4S,5R)-3,4-dihydroxy-5-(hydroxymethyl)oxolan-2-yl]-1,2-dihydropyrimidin-2-ylidene)amino)hexanoic acid	36	C <sub>16</sub> H <sub>19</sub> Na <sub>5</sub> O <sub>7</sub> S	2-Amino-9-(2',3',5'-tri-O-acetyl-b-D-ribofuranosyl)purine	57
C <sub>15</sub> H <sub>26</sub> IN <sub>3</sub> O <sub>4</sub> Si	5'-O-tert-Butylidimethylsilyl-2'-deoxy-5-iodocytidine	134	C <sub>16</sub> H <sub>19</sub> Na <sub>5</sub> O <sub>8</sub>	2-Amino-6-mercapto-9-(2',3',5'-tri-O-acetyl-b-ribofuranosyl)purine	372
C <sub>15</sub> H <sub>26</sub> N <sub>2</sub> O <sub>5</sub> Si	5'-O-tert-Butyldimethylsilyl-2'-deoxyuridine	130	C <sub>16</sub> H <sub>19</sub> Na <sub>5</sub> O <sub>8</sub>	2',3',5'-Tri-O-acetylisosguanosine	371
C <sub>15</sub> H <sub>26</sub> N <sub>2</sub> O <sub>6</sub> Si	2'-O-tert-Butyldimethylsilyluridine	133	C <sub>16</sub> H <sub>20</sub> FN <sub>3</sub> O <sub>7</sub>	2',3',5'-Tri-O-acetylguanosine	135
C <sub>15</sub> H <sub>27</sub> N <sub>3</sub> O <sub>4</sub> Si	3'-Amino-5'-O-tert-butylidimethylsilyl-2,3'-dideoxyuridine	40	C <sub>15</sub> H <sub>19</sub> N <sub>3</sub> O <sub>8</sub> -HCl	Capecitabine 2',3'-cyclic carbonate	370

Formula	Product Name	Page
C <sub>16</sub> H <sub>20</sub> N <sub>5</sub> NaO <sub>10</sub>	3'-Azido-3'-deoxythymidine-b-D-glucuronide sodium salt	86
C <sub>16</sub> H <sub>21</sub> N <sub>5</sub> O <sub>6</sub>	3'-O-Acetyl-2'-deoxy-N2-isobutyluracilinosine	16
C <sub>16</sub> H <sub>22</sub> N <sub>4</sub> O <sub>7</sub>	2,6-Dihydro-9-(2',3',5'-tri-O-acetyl-b-D-ribofuranosyl)purine	248
C <sub>16</sub> H <sub>22</sub> N <sub>2</sub> O <sub>15</sub> P <sub>2</sub> Na <sub>2</sub>	Thymidine-5'-diphosphate-4-keto-6-deoxy-D-glucose disodium salt	363
C <sub>16</sub> H <sub>23</sub> N <sub>5</sub> O <sub>4</sub>	N6-Cyclopentyl-2'-C-methyl-adenosine	158
C <sub>16</sub> H <sub>23</sub> N <sub>5</sub> O <sub>4</sub> S	2-Methylthio-N6-isopentenyladenosine	325
C <sub>16</sub> H <sub>24</sub> N <sub>2</sub> O <sub>15</sub> P <sub>2</sub> Na <sub>2</sub>	Thymidine-5'-diphosphate-L-rhamnose disodium salt	363
	Thymidine-5'-diphosphate-2-deoxy-D-glucose disodium salt	362
C <sub>16</sub> H <sub>24</sub> N <sub>2</sub> Na <sub>2</sub> O <sub>16</sub> P <sub>2</sub>	Thymidine-5'-diphosphate-a-D-glucose disodium salt	363
C <sub>16</sub> H <sub>25</sub> N <sub>2</sub> O <sub>5</sub> SiD <sub>3</sub>	5'-O-tert-Butyldimethylsilyl-D3-thymidine	133
C <sub>16</sub> H <sub>25</sub> N <sub>3</sub> O <sub>14</sub> P <sub>2</sub> Na <sub>2</sub>	Thymidine-5'-diphosphate-D-viosamine disodium salt	363
C <sub>16</sub> H <sub>26</sub> N <sub>6</sub> O <sub>3</sub>	N6-(6-Aminohexyl)-2'-deoxyadenosine	55
C <sub>16</sub> H <sub>26</sub> N <sub>3</sub> O <sub>5</sub> SiD <sub>3</sub>	3'-Amino-5'-O-tert-butylidimethylsilyl-3'-deoxy-D3-thymidine	39
C <sub>16</sub> H <sub>27</sub> N <sub>5</sub> O <sub>4</sub> Si	3'-Azido-5'-O-tert-butylidimethylsilyl-3'-deoxythymidine	83
C <sub>16</sub> H <sub>11</sub> N <sub>5</sub> O <sub>5</sub> PS-C <sub>6</sub> H <sub>14</sub> N	Adenosine 3',5'-cyclic monophosphothioate Rp-isomer triethylammonium salt	22
	Adenosine 3',5'-cyclic monophosphorothioate Sp-isomer triethylammonium salt	22
C <sub>16</sub> H <sub>27</sub> N <sub>6</sub> O <sub>6</sub> P	Adenosine 2',3'-cyclic monophosphate triethylammonium salt	21
C <sub>16</sub> H <sub>27</sub> N <sub>6</sub> O <sub>7</sub> P	Guanosine 2',3'-cyclic phosphate triethylamine salt	283
C <sub>16</sub> H <sub>28</sub> N <sub>2</sub> O <sub>5</sub> Si	5'-O-tert-Butyldimethylsilylthymidine	133
	2,3'-Anhydro-5'-O-tert-butylidimethylsilylthymidine	66
C <sub>16</sub> H <sub>28</sub> N <sub>2</sub> O <sub>6</sub> Si	2'-O-tert-Butyldimethylsilyl-5-methyluridine	132
C <sub>10</sub> H <sub>15</sub> N <sub>5</sub> O <sub>10</sub> P <sub>2</sub> -2C <sub>6</sub> H <sub>13</sub> N	Adenosine 5'-diphosphate bis(cyclohexylammonium) salt	23
C <sub>16</sub> H <sub>29</sub> N <sub>3</sub> O <sub>5</sub> Si	3'-Amino-5'-O-tert-butylidimethylsilyl-3'-deoxythymidine	40
C <sub>10</sub> H <sub>13</sub> N <sub>2</sub> O <sub>15</sub> P <sub>3</sub> -4C <sub>6</sub> H <sub>14</sub> N	2'-Deoxy-5-hydroxymethyluridine-5'-triphosphate triethylammonium salt	208
C <sub>10</sub> H <sub>15</sub> N <sub>5</sub> O <sub>10</sub> P <sub>2</sub> -X(C <sub>6</sub> H <sub>13</sub> N)	Adenosine 3',5'-bisphosphate triethylammonium salt - 10mM aqueous solution	21
C <sub>10</sub> H <sub>15</sub> N <sub>5</sub> O <sub>13</sub> P <sub>2</sub> S-4C <sub>6</sub> H <sub>15</sub> N	3'-Phosphoadenosine 5'-phosphosulfate triethylammonium salt	341
C <sub>10</sub> H <sub>18</sub> N <sub>3</sub> O <sub>14</sub> P <sub>3</sub> -4C <sub>6</sub> H <sub>15</sub> N	2'-C-Methylcytidine 5'-triphosphate triethylammonium salt - Aqueous Solution	314
C <sub>17</sub> H <sub>15</sub> N <sub>2</sub> O <sub>6</sub> D <sub>3</sub>	5'-O-Benzoyl-D3-thymidine	113
C <sub>17</sub> H <sub>15</sub> N <sub>5</sub> O <sub>7</sub> Se	4-Nitrobenzoyl-6-seleninosine	335
C <sub>17</sub> H <sub>16</sub> N <sub>5</sub> O <sub>3</sub>	3'-Azido-N6-benzoyl-2',3'-dideoxyadenosine	81
C <sub>17</sub> H <sub>16</sub> N <sub>5</sub> O <sub>4</sub> D <sub>3</sub>	3'-Azido-5'-O-benzyl-3'-deoxy-D3-thymidine	82
C <sub>17</sub> H <sub>16</sub> FN <sub>5</sub> O <sub>4</sub>	N6-Benzoyl-9-(2'-deoxy-2'-fluoro-b-D-arabinofuranosyl)adenine	104
	N6-Benzoyl-2'-deoxy-2'-fluoroadenosine	104
C <sub>17</sub> H <sub>16</sub> N <sub>2</sub> O <sub>5</sub>	Benzoyl stavudine	112
C <sub>17</sub> H <sub>16</sub> N <sub>3</sub> O <sub>5</sub> D <sub>3</sub>	3'-Amino-5'-O-benzoyl-3'-deoxy-D3-thymidine	37
C <sub>17</sub> H <sub>16</sub> N <sub>2</sub> O <sub>6</sub>	2,2'-Anhydro-5'-O-toluoyluridine	69
C <sub>17</sub> H <sub>16</sub> ClN <sub>5</sub> O <sub>6</sub> PS-Na	8-(4-Chlorophenylthio)-2'-O-methyladenosine 3',5'-cyclic monophosphate sodium salt	151
C <sub>17</sub> H <sub>16</sub> N <sub>2</sub> O <sub>7</sub>	5'-O-p-Anisoyl-2,2'-anhydrouridine	69
C <sub>17</sub> H <sub>16</sub> N <sub>6</sub> Na <sub>2</sub> O <sub>9</sub> PS	6-[(4-Nitrobenzyl)thio]-9-(b-D-ribofuranosyl)purine-5'-monophosphate disodium salt	335
C <sub>17</sub> H <sub>17</sub> N <sub>5</sub> O <sub>3</sub>	N6-Benzoyl-2',3'-dideoxyadenosine	107
C <sub>17</sub> H <sub>17</sub> N <sub>5</sub> O <sub>4</sub>	N6-Benzoyl-3'-deoxyadenosine	97
	N6-Benzoyl-2'-deoxyadenosine	97
	N6-Benzoyl-2'-deoxy-a-adenosine	97
C <sub>17</sub> H <sub>17</sub> N <sub>5</sub> O <sub>5</sub>	N6-Benzoyl-2'-deoxy-8-oxoadenosine	106
	N6-Benzoyl-L-adenosine	93
	N6-Benzoyl-adenosine	93
	3'-Azido-2',3'-dideoxy-5'-O-p-toluoyluridine	91
	3'-Azido-5'-O-benzoyl-3'-deoxythymidine	81
	9-(b-D-Arabinofuranosyl)-N6-benzoyl-adenine	73
C <sub>17</sub> H <sub>17</sub> FN <sub>2</sub> O <sub>6</sub>	5'-O-p-Anisoyl-3'-fluoro-2',3'-dideoxyuridine	71
C <sub>17</sub> H <sub>17</sub> F <sub>2</sub> N <sub>3</sub> O <sub>6</sub>	N-Cbz gemcitabine	138

Formula	Product Name	Page
C <sub>17</sub> H <sub>17</sub> N <sub>5</sub> O <sub>6</sub>	N2-Benzoylguanosine	109
	5'-O-p-Anisoyl-3'-azido-2',3'-dideoxyuridine	70
C <sub>17</sub> H <sub>17</sub> N <sub>5</sub> O <sub>6</sub> S	S-(4-Nitrobenzyl)-6-thioinosine	335
C <sub>17</sub> H <sub>17</sub> N <sub>5</sub> O <sub>7</sub> S	S-(2'-Hydroxy-5-nitrobenzoyl)-6-thioinosine	290
C <sub>17</sub> H <sub>18</sub> N <sub>3</sub> O <sub>4</sub> D <sub>3</sub>	3'-Amino-5'-O-benzyl-3'-deoxy-D3-thymidine	38
C <sub>17</sub> H <sub>18</sub> N <sub>2</sub> O <sub>5</sub>	5'-O-Benzoyl-2,3'-anhydrothymidine	94
	1,5-Anhydro-4,6-O-benzylidene-2,3-dideoxy-2-[uracil-1-yl]-D-glucitol	66
	2,3'-Anhydro-5'-O-benzoylthymidine	66
C <sub>17</sub> H <sub>18</sub> N <sub>2</sub> O <sub>6</sub>	5'-O-Benzoylthymidine	113
	3'-O-Benzoylthymidine	113
C <sub>17</sub> H <sub>18</sub> N <sub>6</sub> O <sub>6</sub> S	S-(4-Nitrobenzyl)-6-thioguanosine	335
C <sub>17</sub> H <sub>18</sub> N <sub>2</sub> O <sub>7</sub>	5'-O-p-Anisoyl-2'-deoxyuridine	71
C <sub>17</sub> H <sub>18</sub> ClN <sub>3</sub> O <sub>7</sub>	6-Chloro-7-deaza-9-(2',3',5'-tri-O-acetyl-b-D-ribofuranosyl)purine	141
C <sub>17</sub> H <sub>18</sub> N <sub>6</sub> O <sub>7</sub> S	S-(2-Hydroxy-5-nitrobenzoyl)-6-thioguanosine	290
C <sub>17</sub> H <sub>19</sub> N <sub>5</sub> O <sub>3</sub>	N6-Benzyl-2-deoxyadenosine	116
	6-Benzylamino-9-(2'-deoxy-b-D-ribofuranosyl)purine	115
C <sub>17</sub> H <sub>19</sub> N <sub>5</sub> O <sub>4</sub>	6-O-Benzyl-2'-deoxyguanosine	116
	6-Benzylamino-9-(b-D-arabinofuranosyl)purine	115
	N6-Benzyladenosine	114
	4-Amino-3-benzyl-1H-pyrazolo[3,4-d]pyrimidine 1-b-D-ribofuranose	38
C <sub>17</sub> H <sub>19</sub> N <sub>3</sub> O <sub>5</sub>	3'-Amino-2',3'-dideoxy-5'-O-toluoyluridine	52
C <sub>17</sub> H <sub>19</sub> N <sub>5</sub> O <sub>5</sub>	p-Topolin riboside	368
	o-Topolin riboside	367
	m-Topolin riboside	367
	8-Benzyloxy-2'-deoxyguanosine	117
	O6-Benzyl guanosine	117
C <sub>17</sub> H <sub>19</sub> N <sub>3</sub> O <sub>6</sub>	N4-Benzoyl-5-methylcytidine	112
	N4-Benzoyl-2'-O-methylcytidine	112
	N4-Anisoyl-2'-deoxycytidine	71
	3'-Amino-5'-O-p-anisoyl-2',3'-dideoxyuridine	36
C <sub>17</sub> H <sub>19</sub> N <sub>5</sub> O <sub>6</sub> S	5-Tosyladenosine	368
C <sub>17</sub> H <sub>19</sub> N <sub>3</sub> O <sub>7</sub>	N4-Benzoyl-1-(a-D-mannopyranosyl)cytosine	111
	N4-p-Anisoylcytidine	71
C <sub>17</sub> H <sub>20</sub> N <sub>4</sub> O <sub>2</sub>	5-(2-Ethoxyphenyl)-1-methyl-3-n-propyl-1,6-dihydro-7H-pyrazolo[4,3-d]pyrimidin-7-one	270
C <sub>17</sub> H <sub>20</sub> N <sub>2</sub> O <sub>5</sub>	5-Octa-1,7-diynyl-2'-deoxyuridine	337
C <sub>17</sub> H <sub>20</sub> N <sub>2</sub> O <sub>7</sub> S	5'-O-Tosylthymidine	368
C <sub>17</sub> H <sub>18</sub> N <sub>5</sub> Na <sub>2</sub> O <sub>7</sub> P-H <sub>2</sub> O	N6-Benzyladenosine-5'-monophosphate sodium salt	114
C <sub>17</sub> H <sub>18</sub> N <sub>5</sub> Na <sub>2</sub> O <sub>8</sub> P-H <sub>2</sub> O	p-Topolin riboside-5'-monophosphate sodium salt	367
	o-Topolin riboside-5'-monophosphate sodium salt	367
	m-Topolin riboside-5'-monophosphate salt	367
C <sub>17</sub> H <sub>21</sub> N <sub>2</sub> O <sub>8</sub>	1-(2,3,5-Tri-O-acetyl-b-D-ribofuranosyl)nicotinamide	372
C <sub>17</sub> H <sub>21</sub> N <sub>5</sub> O <sub>10</sub> P <sub>2</sub>	N6-Benzyladenosine 5'-O-diphosphate sodium salt	114
C <sub>17</sub> H <sub>22</sub> N <sub>5</sub> O <sub>13</sub> P <sub>3</sub>	N6-Benzyladenosine 5'-O-triphosphate sodium salt	114
	4-Amino-3-benzyl-1H-pyrazolo[3,4-d]pyrimidine 1-b-D-ribofuranosyl 5'-triphosphate	38
C <sub>17</sub> H <sub>23</sub> N <sub>5</sub> O <sub>7</sub>	7-(4,5-cis-Dihydroxy-1-cyclopenten-3-ylaminomethyl)-7-deazaguanosine	248
C <sub>17</sub> H <sub>23</sub> N <sub>5</sub> O <sub>14</sub>	Polyoxorim	342
C <sub>17</sub> H <sub>24</sub> N <sub>6</sub> O <sub>17</sub> P <sub>2</sub> -2Na	UDP-N-azidoacetylgalactosamine	379
C <sub>17</sub> H <sub>25</sub> N <sub>5</sub> O <sub>13</sub>	Polyoxin B	342
C <sub>17</sub> H <sub>29</sub> N <sub>3</sub> O <sub>6</sub> Si	N4-Acetyl-2'-O-tert-butylidimethylsilyl-cytidine	11
	N4-Acetyl-2'-O-tert-butylidimethylsilylcytidine	11
C <sub>11</sub> H <sub>18</sub> N <sub>5</sub> O <sub>14</sub> P <sub>3</sub> -4C <sub>6</sub> H <sub>15</sub> N	2'-C-Methylguanosine 5'-triphosphate triethyl ammonium salt - Aqueous solution	318
C <sub>18</sub> H <sub>15</sub> BrN <sub>2</sub> O <sub>2</sub>	5-Bromo-2,4-di(benzyloxy)pyrimidine	126
C <sub>18</sub> H <sub>16</sub> N <sub>5</sub> O <sub>6</sub> D <sub>3</sub>	5'-O-p-Anisoyl-3'-azido-3'-deoxy-D3-thymidine	70
C <sub>18</sub> H <sub>17</sub> N <sub>2</sub> O <sub>7</sub> D <sub>3</sub>	5'-O-p-Anisoyl-D3-thymidine	71
C <sub>17</sub> H <sub>16</sub> FN <sub>5</sub> O <sub>7</sub> S-HCl	5'-(4-Fluorosulfonylbenzoyl)adenosine HCl	279
C <sub>18</sub> H <sub>18</sub> ClN <sub>6</sub> O <sub>4</sub>	2-Chloro-N6-(3-iodobenzyl)-adenosine-5'-N-methyluracilamide	147
C <sub>18</sub> H <sub>19</sub> Cl <sub>2</sub> N <sub>2</sub> O <sub>7</sub>	5,6-Dichloropurine-1-(2,3,5-tri-O-acetyl-b-D-ribofuranosyl)-1H-benzimidazole	237
C <sub>18</sub> H <sub>18</sub> N <sub>3</sub> O <sub>7</sub> D <sub>3</sub>	3'-Amino-5'-O-p-anisoyl-3'-deoxy-D3-thymidine	36

# Formula Index

C<sub>21</sub>H<sub>26</sub>N<sub>6</sub>O<sub>16</sub>P<sub>2</sub>

Formula	Product Name	Page
C <sub>18</sub> H <sub>19</sub> N <sub>5</sub> O <sub>4</sub>	1,5-Anhydro-2,3-dideoxy-2-(N6-benzoyladenin-1-yl)-D-glucitol	67
C <sub>18</sub> H <sub>19</sub> N <sub>6</sub> O <sub>4</sub>	N(6)-(3-Iodobenzyl)-5'-N-methylcarboxamidoadenosine	294
C <sub>18</sub> H <sub>19</sub> FN <sub>2</sub> O <sub>5</sub>	3'-Deoxy-3'-fluoro-5'-O-toluoylthymidine	202
C <sub>18</sub> H <sub>19</sub> N <sub>5</sub> O <sub>5</sub>	2'-Deoxy-N6-phenoxyacetyladenosine	218
	N6-Benzoyl-3'-O-methyladenosine	111
	N6-Benzoyl-2'-O-methyladenosine	111
C <sub>18</sub> H <sub>19</sub> FN <sub>2</sub> O <sub>6</sub>	5'-O-p-Anisoyl-3'-fluoro-3'-deoxythymidine	71
C <sub>18</sub> H <sub>19</sub> N <sub>5</sub> O <sub>6</sub>	N2-Phenylacetyl-L-guanosine	339
	N2-Phenylacetylguanosine	339
	N6-(4-Methoxybenzoyl)adenosine	329
	2'-Deoxy-N2-phenoxyacetylguanosine	218
	N6-Benzoyl-9-(a-D-mannopyranosyl)adenine	110
	5'-O-p-Anisoyl-3'-azido-3'-deoxythymidine	70
C <sub>18</sub> H <sub>19</sub> N <sub>6</sub> O <sub>7</sub>	N2-Phenoxyacetylguanosine	339
C <sub>18</sub> H <sub>20</sub> ClN <sub>5</sub> O <sub>5</sub>	2-[2-(4-Chlorophenyl)ethoxy]adenosine	150
C <sub>18</sub> H <sub>20</sub> FN <sub>5</sub> O <sub>5</sub>	2-[2-(4-Fluorophenyl)ethoxy]adenosine	279
C <sub>18</sub> H <sub>20</sub> N <sub>2</sub> O <sub>5</sub>	2,3'-Anhydro-5'-O-p-anisoylthymidine	64
C <sub>18</sub> H <sub>20</sub> N <sub>2</sub> O <sub>7</sub>	5'-O-p-Anisoylthymidine	72
C <sub>18</sub> H <sub>20</sub> ClN <sub>5</sub> O <sub>8</sub>	2-Acetamido-6-chloro-9-(2',3',5'-tri-O-acetyl-b-D-ribofuranosyl)purine	10
C <sub>18</sub> H <sub>20</sub> N <sub>6</sub> O <sub>14</sub> P <sub>3</sub> S	2/3--O-(N-Methylanthraniloyl)guanosine-5'-(γ-thio)triphosphate triethylammonium salt	312
C <sub>18</sub> H <sub>21</sub> N <sub>5</sub> O <sub>5</sub>	o-Methoxytopolin riboside	308
	m-Methoxytopolin riboside	308
	6-Benzylamino-9-(a-D-glucopyranosyl)purine	115
C <sub>18</sub> H <sub>21</sub> N <sub>3</sub> O <sub>6</sub>	3'-Amino-5'-O-p-anisoyl-3'-deoxythymidine	36
C <sub>18</sub> H <sub>21</sub> N <sub>6</sub> O <sub>6</sub> P	2/3-(N-Methylanthraniloyl)-adenosine-5'-monophosphate triethylammonium salt	311
C <sub>18</sub> H <sub>21</sub> N <sub>5</sub> O <sub>9</sub>	N6-Acetyl-2',3',5'-tri-O-acetyl-8-hydroxyadenosine	20
C <sub>18</sub> H <sub>21</sub> NaNa <sub>2</sub> O <sub>15</sub> P <sub>3</sub>	P3-(1-(2-Nitrophenyl)ethyl)adenosine 5'-triphosphate disodium salt	336
C <sub>18</sub> H <sub>22</sub> N <sub>4</sub> O <sub>2</sub> S	4-(1-Benzylpiperidin-4-Ylamino)-2-(Methylthio)Pyrimidine-5-Carboxylic Acid	117
C <sub>18</sub> H <sub>22</sub> N <sub>6</sub> O <sub>11</sub> P <sub>2</sub>	2/3'-O-(N-Methylanthraniloyl)-adenosine-5'-diphosphate triethylammonium salt	311
C <sub>18</sub> H <sub>23</sub> N <sub>5</sub> O <sub>8</sub>	2',3',5'-Tri-O-acetyl-N2-dimethylguanosine	371
	2',3',5'-Tri-O-acetyl-2N,2N-dimethylguanosine	371
C <sub>18</sub> H <sub>23</sub> N <sub>6</sub> O <sub>8</sub> P·Na	N6,2'-O-Dibutylryladenosine 3',5'-cyclic monophosphate sodium salt	235
C <sub>18</sub> H <sub>23</sub> N <sub>6</sub> O <sub>13</sub> P <sub>3</sub>	3'-(N-Methyl-anthraniloyl)-2'-deoxy-adenosine-5'-triphosphate triethylammonium salt	312
	2'-O-(N-Methylanthraniloyl)-3'-deoxy-adenosine-5'-triphosphate triethylammonium salt	312
C <sub>18</sub> H <sub>23</sub> N <sub>6</sub> O <sub>13</sub> P <sub>3</sub> S	2/3'-O-(N-Methyl-anthraniloyl)-adenosine-5'-(gamma-thio)-triphosphate triethylammonium salt	311
C <sub>18</sub> H <sub>23</sub> N <sub>6</sub> O <sub>14</sub> P <sub>3</sub>	2/3'-(N-Methylanthraniloyl)-adenosine-5'-triphosphate triethylammonium salt	312
C <sub>18</sub> H <sub>23</sub> N <sub>6</sub> O <sub>16</sub> P <sub>3</sub>	Caged GTP	134
C <sub>18</sub> H <sub>23</sub> N <sub>5</sub> Na <sub>4</sub> O <sub>21</sub> P <sub>4</sub>	2'-Deoxycytidine P <sup>III</sup> -5'-ester with uridine 5'-(pentahydrogen tetraphosphate) sodium salt	175
C <sub>18</sub> H <sub>24</sub> N <sub>6</sub> O <sub>5</sub>	5'-Azido-N6-Boc-5'-deoxy-2',3'-O-isopropylideneadenosine	83
C <sub>18</sub> H <sub>24</sub> N <sub>5</sub> O <sub>6</sub> P	N-(9-b-D-Ribofuranosyl-9H-furin-6-yl)-butyramide cyclic 3',5'-(hydrogen phosphate) 2'-butyrate	350
C <sub>18</sub> H <sub>24</sub> N <sub>6</sub> O <sub>6</sub> P·1/2Ca	N6,2'-O-Dibutylryladenosine 3',5'-cyclic monophosphate calcium salt	235
C <sub>18</sub> H <sub>26</sub> FN <sub>3</sub> O <sub>4</sub> S	5-(4-Amino-5-fluoro-2-oxo-1(2H)-pyrimidinyl)-1,3-oxathiolane-2-carboxylic acid 5-methyl-2-(1-methylethyl)cyclohexyl ester	54
C <sub>18</sub> H <sub>23</sub> N <sub>4</sub> O <sub>14</sub> P·NH <sub>3</sub>	Uridyl-2'-5'-uridine ammonium salt	382
C <sub>18</sub> H <sub>27</sub> N <sub>5</sub> O <sub>4</sub>	3'-Deoxy-N6-octanoyladenosine	217
C <sub>18</sub> H <sub>27</sub> N <sub>5</sub> O <sub>5</sub>	2-(2-Cyclohexylethoxy)adenosine	152
C <sub>18</sub> H <sub>27</sub> N <sub>5</sub> O <sub>13</sub> P	Uridyl-3'-5'-cytidine ammonium salt	387
C <sub>18</sub> H <sub>24</sub> N <sub>5</sub> O <sub>13</sub> P·NH <sub>3</sub>	Cytidyl-3'-5'-uridine ammonium salt	163
C <sub>19</sub> H <sub>13</sub> N <sub>3</sub> O <sub>4</sub>	2'-Deoxy-a-cytidine	177
C <sub>19</sub> H <sub>19</sub> FN <sub>2</sub> O <sub>7</sub>	2'-O-Acetyl-3'-deoxy-3'-fluoro-5'-O-toluoyluridine	16
C <sub>19</sub> H <sub>20</sub> N <sub>2</sub> O <sub>7</sub>	2'-O-Acetyl-5'-O-benzoyl-3'-deoxy-5-methyluridine	11

Formula	Product Name	Page
C <sub>19</sub> H <sub>20</sub> N <sub>2</sub> O <sub>7</sub>	2'-O-Acetyl-5'-O-benzoyl-3'-deoxy-3'-C-methyluridine	11
C <sub>19</sub> H <sub>21</sub> N <sub>5</sub> O <sub>4</sub>	(R)-N-(2,3-Dihydro-1H-indenyl)adenosine	247
C <sub>19</sub> H <sub>21</sub> N <sub>5</sub> O <sub>6</sub>	2'-O-Methyl-N6-phenoxyacetyladenosine	321
C <sub>19</sub> H <sub>21</sub> N <sub>5</sub> O <sub>7</sub>	N2-Phenoxyacetyl-2'-O-methylguanosine	339
C <sub>19</sub> H <sub>21</sub> N <sub>6</sub> O <sub>10</sub> P	4,5-Dimethoxy-2-nitrobenzyl adenosine 3',5'-cyclic monophosphate	249
C <sub>19</sub> H <sub>22</sub> N <sub>6</sub> O <sub>4</sub>	N6-Benzyl-5'-ethylcarboxamidoadenosine	116
C <sub>19</sub> H <sub>24</sub> N <sub>7</sub> O <sub>12</sub> P	Adenyl-3'-5'-uridine ammonium salt	30
C <sub>19</sub> H <sub>24</sub> N <sub>7</sub> O <sub>13</sub> P	Uridyl-3'-5'-guanosine ammonium salt	382
C <sub>19</sub> H <sub>25</sub> N <sub>5</sub> O <sub>6</sub>	2'-Deoxy-N2-isobutyl-3'-O-levulinoylguanosine	211
	2'-Deoxy-N2-isobutyl-5'-O-levulinoylguanosine	211
C <sub>19</sub> H <sub>25</sub> N <sub>5</sub> O <sub>7</sub>	2'-Deoxy-N2-isobutyl-5'-O-levulinoylguanosine	211
C <sub>19</sub> H <sub>25</sub> N <sub>6</sub> O <sub>11</sub> P	Adenyl-3'-5'-cytidine	29
C <sub>19</sub> H <sub>25</sub> N <sub>6</sub> O <sub>12</sub> P	Cytidyl-3'-5'-guanosine ammonium salt	162
C <sub>19</sub> H <sub>25</sub> N <sub>6</sub> O <sub>14</sub> P <sub>3</sub>	2/3'-O-(N-Methylanthraniloyl)-N6-methyladenosine-5'-triphosphate triethylammonium salt	312
C <sub>19</sub> H <sub>26</sub> FN <sub>3</sub> O <sub>8</sub>	2',3'-Di-O-acetyl-5'-deoxy-5'-fluoro-N4-(pentoxycarbonyl)cytidine	227
C <sub>19</sub> H <sub>26</sub> Na <sub>4</sub> O <sub>10</sub>	2',3'-Di-O-acetyl-5'-deoxy-5'-nitro-N4-(pentylloxycarbonyl)cytidine	228
C <sub>19</sub> H <sub>27</sub> Na <sub>2</sub> O <sub>12</sub> P	Uridyl-3'-5'-adenosine ammonium salt	382
C <sub>19</sub> H <sub>24</sub> N <sub>7</sub> O <sub>13</sub> P·NH <sub>3</sub>	Guanyl-3'-5'-uridine ammonium salt	287
C <sub>19</sub> H <sub>25</sub> N <sub>6</sub> O <sub>16</sub> P·NH <sub>3</sub>	2'-Deoxycytidyl-(3'-5')-2'-deoxyguanosine	177
C <sub>19</sub> H <sub>25</sub> N <sub>6</sub> O <sub>12</sub> P·NH <sub>3</sub>	Guanyl-3'-5'-cytidine ammonium salt	287
C <sub>19</sub> H <sub>28</sub> N <sub>10</sub> O <sub>13</sub> P <sub>2</sub>	5'-Phosphoryl-(3'-amino-3'-deoxyguanylyl)-(3'-5')-3'-amino-3'-deoxycytidine	341
C <sub>20</sub> H <sub>19</sub> ClFN <sub>4</sub> O <sub>5</sub>	2'-O-Acetyl-2-chloro-3'-deoxy-3'-fluoro-5'-O-toluoylinosine	12
C <sub>20</sub> H <sub>20</sub> F <sub>2</sub> N <sub>10</sub> O <sub>12</sub> P <sub>2</sub> ·2Na	2'-Fluoro-cyclic-di-guanlylate monophosphate sodium salt	276
C <sub>20</sub> H <sub>21</sub> N <sub>5</sub> O <sub>5</sub>	N6-Benzoyl-2',3'-isopropylideneadenosine	110
C <sub>20</sub> H <sub>21</sub> N <sub>3</sub> O <sub>7</sub>	3',5'-Di-O-acetyl-N4-benzoyl-2'-deoxycytidine	226
C <sub>20</sub> H <sub>22</sub> N <sub>10</sub> O <sub>13</sub> P <sub>2</sub> ·2Na	3',3'-Cyclic GAMP	157
C <sub>20</sub> H <sub>24</sub> N <sub>6</sub> O <sub>4</sub>	5'-O-Benzyl-N2-DMF-2'-deoxyguanosine	116
C <sub>20</sub> H <sub>24</sub> N <sub>10</sub> O <sub>12</sub> P <sub>2</sub> ·xNa	Cyclic di-adenosine monophosphate sodium salt	156
C <sub>20</sub> H <sub>24</sub> N <sub>10</sub> O <sub>14</sub> P <sub>2</sub>	Cyclic diguanosine monophosphate	157
C <sub>20</sub> H <sub>25</sub> N <sub>10</sub> O <sub>14</sub> P <sub>2</sub>	Adenyl-3'-5'-adenosine ammonium salt	29
C <sub>20</sub> H <sub>25</sub> N <sub>10</sub> O <sub>11</sub> P	Adenyl-3'-5'-guanosine ammonium salt	29
C <sub>20</sub> H <sub>25</sub> N <sub>10</sub> O <sub>11</sub> P·K	Guanyl-3'-5'-adenosine potassium salt	287
C <sub>20</sub> H <sub>26</sub> N <sub>10</sub> O <sub>15</sub> P <sub>2</sub> ·xNa	5'-Phosphoguanyl-3'->5'-guanosine	341
C <sub>20</sub> H <sub>26</sub> N <sub>10</sub> O <sub>22</sub> P <sub>5</sub> Li <sub>3</sub>	P1,P5-Di(adenosine-5')pentaphosphate trithium salt	229
C <sub>20</sub> H <sub>27</sub> N <sub>10</sub> O <sub>16</sub> P <sub>3</sub>	P1-(5'-Adenosyl) P3-(5'-adenosyl) triphosphate sodium salt	29
C <sub>20</sub> H <sub>25</sub> N <sub>10</sub> O <sub>11</sub> P·HaNa	ADENYL-L-(3'-5')-GUANOSINE	30
C <sub>20</sub> H <sub>25</sub> N <sub>10</sub> O <sub>12</sub> P·HaNa	Guanyl-3',5'-guanosine ammonium salt	287
C <sub>20</sub> H <sub>26</sub> N <sub>7</sub> O <sub>16</sub> P·NH <sub>3</sub>	Thymidyl-(3'-5')-2'-deoxyadenosine ammonium salt	366
C <sub>20</sub> H <sub>29</sub> N <sub>10</sub> O <sub>22</sub> P <sub>5</sub> ·5Na	Diadenosine pentaphosphate pentasodium salt	229
C <sub>20</sub> H <sub>30</sub> ClN <sub>3</sub> O <sub>4</sub> Si	6-Chloro-7-deaza-9-(5'-O-tert-butylidimethylsilyl)-2',3'-O-isopropylidene-b-D-ribofuranosyl)purine	141
C <sub>20</sub> H <sub>30</sub> N <sub>5</sub> O <sub>12</sub> P	U-13C10, U-[15N2]-Labelled Thymidyl-3'-5'-thymidine ammonium	383
C <sub>20</sub> H <sub>27</sub> N <sub>4</sub> O <sub>12</sub> P·NH <sub>3</sub>	Thymidyl-3'-5'-thymidine ammonium salt	366
C <sub>20</sub> H <sub>33</sub> ClN <sub>4</sub> O <sub>4</sub> Si	9-(5'-O-t-Butylidimethylsilyl)-2',3'-O-isopropylidene-b-D-ribofuranosyl)-6-chloro-7-deazaguanine	132
C <sub>20</sub> H <sub>33</sub> N <sub>5</sub> O <sub>6</sub> Si	2'-O-tert-Butylidimethylsilyl-N2-isobutylrylguanosine	132
C <sub>20</sub> H <sub>46</sub> N <sub>5</sub> O <sub>12</sub> P <sub>3</sub> S	Lamivudine 5'-triphosphate triethylammonium salt	302
C <sub>21</sub> H <sub>22</sub> N <sub>10</sub> O <sub>4</sub>	N-(2-Amino-3,8-dimethylimidazo[4,5-f]quinoxalin-5-yl)-2'-deoxyguanosine	53
C <sub>21</sub> H <sub>23</sub> N <sub>5</sub> O <sub>6</sub>	3',5'-Di-O-acetyl O6-benzyl-2'-deoxyguanosine	229
C <sub>21</sub> H <sub>23</sub> N <sub>5</sub> O <sub>8</sub>	5'-O-Benzoyl-2'-deoxy-N2-isobutylrylguanosine	105
	3'-O-Benzoyl-2'-deoxy-N2-isobutylrylguanosine	105
C <sub>21</sub> H <sub>23</sub> N <sub>3</sub> O <sub>7</sub>	N4-Benzoyl-2'-deoxy-5'-O-levulinoylcytidine	106
	N4-Benzoyl-2'-deoxy-3'-O-levulinoylcytidine	106
C <sub>21</sub> H <sub>24</sub> N <sub>5</sub> O <sub>13</sub> P <sub>3</sub>	4-Amino-3-(1-naphthylmethyl)-1H-pyrazolo[3,4-d]pyrimidine-1-(b-D-ribofuranosyl-5'-triphosphate)	59
C <sub>21</sub> H <sub>26</sub> N <sub>6</sub> O <sub>16</sub> P <sub>2</sub>	Adenosine-5'-O-diphospho-(1''-(4-nitrophenyl)-ribose)	24

Formula	Product Name	Page
C <sub>21</sub> H <sub>26</sub> N <sub>7</sub> Na <sub>2</sub> O <sub>17</sub> P <sub>3</sub>	b-Nicotinamide adenine dinucleotide phosphate disodium salt	331
C <sub>21</sub> H <sub>26</sub> N <sub>7</sub> O <sub>17</sub> P <sub>3</sub> ·4Na	b-Nicotinamide adenine dinucleotide phosphate, reduced form, tetrasodium salt - min 95%	332
C <sub>21</sub> H <sub>26</sub> N <sub>7</sub> O <sub>19</sub> P <sub>3</sub> ·2Na	b-Nicotinamide adenine dinucleotide phosphate, reduced form, disodium salt	331
C <sub>21</sub> H <sub>27</sub> N <sub>7</sub> O <sub>14</sub> P <sub>2</sub>	b-Nicotinamide adenine dinucleotide	333
C <sub>21</sub> H <sub>27</sub> N <sub>7</sub> O <sub>14</sub> P <sub>2</sub> ·2Na	b-Nicotinamide adenine dinucleotide reduced form, disodium salt	333
C <sub>21</sub> H <sub>27</sub> KN <sub>7</sub> O <sub>17</sub> P <sub>3</sub>	b-Nicotinamide adenine dinucleotide phosphate potassium salt hydrate	331
C <sub>21</sub> H <sub>27</sub> N <sub>7</sub> NaO <sub>17</sub> P <sub>3</sub>	b-Nicotinamide adenine dinucleotide phosphate sodium salt hydrate	332
C <sub>21</sub> H <sub>28</sub> NeO <sub>9</sub>	(S)-4,9-Dihydro-a-[(methoxycarbonyl)amino]-4,6-dimethyl-9-oxo-3-b-D-ribofuranosyl-3H-Imidazo[1,2-a]purine-7-butanolic acid methyl ester	247
C <sub>21</sub> H <sub>28</sub> N <sub>7</sub> O <sub>15</sub> P <sub>2</sub> ·xNa	Nicotinamide guanine dinucleotide sodium salt	334
C <sub>21</sub> H <sub>26</sub> N <sub>7</sub> NaO <sub>14</sub> P <sub>2</sub> ·2H <sub>2</sub> O	b-Nicotinamide adenine dinucleotide sodium salt dihydrate	333
C <sub>21</sub> H <sub>28</sub> N <sub>7</sub> O <sub>17</sub> P <sub>3</sub>	a-Nicotinamide adenine dinucleotide phosphate	332
C <sub>21</sub> H <sub>28</sub> NaO <sub>5</sub> P	5-O-[[[(1S)-1-Methyl-2-(1-methylethoxy)-2-oxoethyl]amino]-phenoxyphosphinyl]-cytidine	320
C <sub>21</sub> H <sub>29</sub> N <sub>7</sub> O <sub>17</sub> P <sub>3</sub> D	b-Nicotinamide-D adenine dinucleotide reduced form	333
C <sub>21</sub> H <sub>30</sub> ClN <sub>5</sub> O <sub>9</sub>	N2-Diboc-7/9-(2,3,4,6-tetra-O-acetyl-D-mannopyranosyl)-6-chloro-2-aminopurine	234
C <sub>21</sub> H <sub>28</sub> N <sub>7</sub> O <sub>17</sub> P <sub>3</sub> ·xH <sub>2</sub> O	b-Nicotinamide adenine dinucleotide phosphate hydrate	331
C <sub>21</sub> H <sub>31</sub> N <sub>5</sub> O <sub>10</sub>	trans-Zeatin-o-glucoside riboside	384
	cis-Zeatin-o-glucoside riboside	384
C <sub>21</sub> H <sub>36</sub> N <sub>2</sub> O <sub>7</sub> Si <sub>2</sub>	3',5'-O-(1,1,3,3-Tetraisopropyl)disiloxane-1,3-diyyl)-2'-ketouridine	355
C <sub>21</sub> H <sub>33</sub> Li <sub>3</sub> N <sub>7</sub> O <sub>16</sub> P <sub>3</sub> S	Coenzyme A trillithium salt	155
C <sub>21</sub> H <sub>36</sub> N <sub>7</sub> O <sub>16</sub> P <sub>3</sub> SNa	Coenzyme A sodium salt hydrate	154
C <sub>21</sub> H <sub>38</sub> N <sub>2</sub> O <sub>6</sub> Si <sub>2</sub>	2'-Deoxy-3',5'-O-(1,1,3,3-tetraisopropyl-1,3-disiloxanediyl)uridine	221
C <sub>21</sub> H <sub>38</sub> N <sub>2</sub> O <sub>7</sub> Si <sub>2</sub>	3',5'-O-(1,1,3,3-Tetraisopropyl-1,3-disiloxanediyl)uridine	356
C <sub>21</sub> H <sub>36</sub> N <sub>7</sub> O <sub>16</sub> P <sub>3</sub> S·xH <sub>2</sub> O	Coenzyme A hydrate	154
C <sub>21</sub> H <sub>39</sub> BrN <sub>5</sub> O <sub>5</sub> Si <sub>2</sub>	3',5'-Bis-O-(tert-butyl)dimethylsilyl)-5-bromo-2'-deoxyuridine	120
C <sub>21</sub> H <sub>39</sub> N <sub>3</sub> O <sub>6</sub> Si <sub>2</sub>	3',5'-O-(1,1,3,3-Tetraisopropyl-1,3-disiloxanediyl)cytidine	355
C <sub>21</sub> H <sub>40</sub> N <sub>2</sub> O <sub>5</sub> Si <sub>2</sub>	3',5'-Bis-O-(tert-butyl)dimethylsilyl)-2'-deoxyuridine	121
C <sub>21</sub> H <sub>43</sub> N <sub>4</sub> O <sub>6</sub> PS	2-Thiouridine-5'-monophosphate triethylammonium salt - Aqueous solution	361
C <sub>21</sub> H <sub>27</sub> N <sub>7</sub> O <sub>17</sub> P <sub>3</sub> ·xNa·yH <sub>2</sub> O	b-Nicotinamide adenine dinucleotide 3'-phosphate sodium salt hydrate	332
C <sub>8</sub> <sup>13</sup> CH <sub>10</sub> F <sub>15</sub> N <sub>2</sub> O <sub>5</sub>	2'-Deoxy-2',2'-difluorouridine (13C, 15N) labelled	179
C <sub>22</sub> H <sub>17</sub> NeO <sub>4</sub> D <sub>5</sub>	8-(4-Amino-2',3',4',5',6'-D5-biphenyl)-2'-deoxyguanosine	39
C <sub>22</sub> H <sub>17</sub> N <sub>5</sub> O <sub>8</sub>	AFB-guanine	30
C <sub>22</sub> H <sub>22</sub> NeO <sub>4</sub>	N-(2'-Deoxyguanosin-8-yl)-4-amino(biphenyl)	207
C <sub>22</sub> H <sub>23</sub> N <sub>5</sub> O <sub>5</sub>	2-[2-(2-Naphthalenyl)ethoxy]adenosine	330
C <sub>22</sub> H <sub>23</sub> N <sub>5</sub> O <sub>6</sub>	N6-Benzoyl-2'-deoxy-5'-O-levulinoyl adenosine	106
	N6-Benzoyl-2'-deoxy-3'-O-levulinoyl adenosine	105
C <sub>22</sub> H <sub>25</sub> N <sub>5</sub> O <sub>5</sub>	1,5-Anhydro-4,6-O-benzylidene-2,3-dideoxy-2-(N2-isobutyluranylguanidin-1-yl)-D-glucitol	66
C <sub>22</sub> H <sub>28</sub> NeO <sub>14</sub> P <sub>2</sub>	3-Acetylpyridine adenine dinucleotide	20
C <sub>22</sub> H <sub>28</sub> NeO <sub>14</sub> P <sub>2</sub> Na <sub>2</sub>	3-Acetylpyridine adenine dinucleotide, reduced form, sodium salt	20
C <sub>22</sub> H <sub>30</sub> NeO <sub>4</sub> Si	3'-Azido-N4-benzoyl-5'-O-tert-butyl)dimethylsilyl)-2',3'-dideoxycytidine	80
C <sub>22</sub> H <sub>30</sub> N <sub>3</sub> O <sub>5</sub> Si	N4-Benzoyl-5'-O-tert-butyl)dimethylsilyl)-2'-deoxy-5-iodocytidine	95
C <sub>22</sub> H <sub>29</sub> N <sub>7</sub> O <sub>5</sub> ·2HCl	Puromycin dihydrochloride	346
C <sub>15</sub> H <sub>23</sub> NeO <sub>5</sub> S·C <sub>7</sub> H <sub>7</sub> O <sub>3</sub> S	S-Adenosyl-L-methionine p-toluenesulfonate	28
C <sub>22</sub> H <sub>31</sub> N <sub>3</sub> O <sub>4</sub> Si	2,3'-Anhydro-5'-O-tert-butyl)dimethylsilyl)-N4-benzoyl-2'-deoxycytidine	66
C <sub>22</sub> H <sub>31</sub> N <sub>3</sub> O <sub>5</sub> Si	N4-Benzoyl-5'-O-tert-butyl)dimethylsilyl)-2'-deoxycytidine	95
C <sub>22</sub> H <sub>31</sub> N <sub>3</sub> O <sub>6</sub> Si	N4-Benzoyl-2'-O-tert-butyl)dimethylsilyl)cytidine	95

Formula	Product Name	Page
C <sub>22</sub> H <sub>32</sub> N <sub>4</sub> O <sub>4</sub> Si	3'-Amino-N4-benzoyl-5'-O-tert-butyl)dimethylsilyl)-2',3'-dideoxycytidine	37
C <sub>22</sub> H <sub>34</sub> N <sub>6</sub> O <sub>16</sub> P <sub>3</sub> S·xLi	Biotin-5-deoxyuridine-5'-triphosphate, lithium salt - 1 mM aqueous solution	119
C <sub>15</sub> H <sub>22</sub> NeO <sub>5</sub> S·C <sub>7</sub> H <sub>7</sub> O <sub>3</sub> S	S-Adenosyl-L-methionine disulfate tosylate	28
C <sub>22</sub> H <sub>34</sub> N <sub>5</sub> O <sub>17</sub> P <sub>3</sub> S·xLi	Biotin-5-uridine-5'-triphosphate, lithium salt - 1 mM aqueous solution	120
C <sub>22</sub> H <sub>35</sub> N <sub>5</sub> O <sub>4</sub>	3'-Deoxy-N6-lauroyladenosine	212
C <sub>22</sub> H <sub>35</sub> NeO <sub>15</sub> P <sub>3</sub> S	Biotin-5-deoxycytidine-5'-triphosphate, lithium salt - 1 mM aqueous solution	119
C <sub>22</sub> H <sub>35</sub> NeO <sub>16</sub> P <sub>3</sub> S·xLi	Biotin-5-cytidine-5'-triphosphate lithium salt - 1 mM aqueous solution	118
C <sub>22</sub> H <sub>38</sub> BrN <sub>5</sub> O <sub>5</sub> Si <sub>2</sub>	8-Bromo-9-[3',5'-O-(1,1,3,3-tetraisopropyl-1,3-disiloxanediyl)-2'-deoxy-b-D-ribofuranosyl]guanine	128
C <sub>22</sub> H <sub>39</sub> N <sub>5</sub> O <sub>5</sub> Si <sub>2</sub>	3',5'-O-(1,1,3,3-Tetraisopropyl-1,3-disiloxanediyl)adenosine	355
C <sub>22</sub> H <sub>39</sub> N <sub>5</sub> O <sub>6</sub> Si <sub>2</sub>	3',5'-O-[Tetrakis(1-methylethyl)-1,3-disiloxanediyl]-guanosine	356
	3',5'-O-(1,1,3,3-Tetraisopropyl-1,3-disiloxanediyl)guanosine	355
C <sub>22</sub> H <sub>40</sub> NeO <sub>5</sub> Si <sub>2</sub>	2,6-Diamino-9-[3',5'-O-(1,1,3,3-tetraisopropyl-1,3-disiloxanediyl)-b-D-ribofuranosyl]purine	232
C <sub>22</sub> H <sub>40</sub> N <sub>2</sub> O <sub>7</sub> Si <sub>2</sub>	3',5'-O-(1,1,3,3-Tetraisopropyl-1,3-disiloxanediyl)-5-methyluridine	356
C <sub>10</sub> H <sub>13</sub> ClN <sub>5</sub> O <sub>7</sub> P·C <sub>12</sub> H <sub>30</sub> N <sub>2</sub>	2-Chloroadenosine 5'-monophosphate triethylamine salt	139
C <sub>22</sub> H <sub>46</sub> N <sub>7</sub> O <sub>13</sub> P <sub>3</sub>	3'-Azido-3'-deoxythymidine 5'-triphosphate triethylammonium salt	88
C <sub>22</sub> H <sub>17</sub> Cl <sub>2</sub> FN <sub>2</sub> O <sub>7</sub>	3',5'-Di-O-p-chlorobenzoyl-2'-deoxy-5-fluorouridine	236
	3',5'-Di-O-p-chlorobenzoyl-2'-deoxy a-5-fluorouridine	236
C <sub>23</sub> H <sub>18</sub> BrN <sub>2</sub> O <sub>7</sub>	1-(3',5'-Di-O-benzoyl-2'-deoxy-2'-fluoro-b-D-arabinofuranosyl)-5-bromo-uracil	233
C <sub>23</sub> H <sub>18</sub> F <sub>2</sub> N <sub>2</sub> O <sub>7</sub>	3',5'-Di-O-benzoyl-2'-deoxy-2',2'-difluorouridine	233
C <sub>23</sub> H <sub>19</sub> F <sub>2</sub> N <sub>3</sub> O <sub>6</sub>	1'-Epi gemcitabine 3',5'-dibenzate	268
	3',5'-Di-O-benzoyl-2'-deoxy-2',2'-difluorocytidine	233
C <sub>23</sub> H <sub>19</sub> FN <sub>2</sub> O <sub>7</sub>	3',5'-Di-O-benzoyl-2'-deoxy-2'-fluorouridine	234
C <sub>23</sub> H <sub>19</sub> N <sub>2</sub> O <sub>7</sub> F	1-(3',5'-Di-O-benzoyl-2'-deoxy-2'-fluoro-b-D-arabinofuranosyl)uracil	234
C <sub>23</sub> H <sub>19</sub> FN <sub>2</sub> O <sub>7</sub>	1-(3',5'-Di-O-benzoyl-2'-deoxy-2'-fluoro-b-D-arabinofuranosyl)thymine	234
	1-(2'-deoxy-2'-fluoro-3',5'-di-O-benzoyl-b-L-arabinofuranosyl)-uracil	196
C <sub>23</sub> H <sub>20</sub> D <sub>3</sub> NaO <sub>4</sub>	8-(2-Amino-1-methyl-D3-6-phenylimidazo[4,5-b]pyridyl)-2'-deoxyguanosine	58
C <sub>23</sub> H <sub>20</sub> N <sub>6</sub> O <sub>5</sub>	3'-Azido-N4-benzoyl-5'-O-benzoyl-2',3'-dideoxycytidine	80
C <sub>23</sub> H <sub>20</sub> N <sub>2</sub> O <sub>8</sub>	2',3'-Di-O-benzoyluridine	234
C <sub>23</sub> H <sub>21</sub> N <sub>3</sub> O <sub>5</sub>	2,3'-Anhydro-5'-O-benzoyl-N4-benzoyl-2'-deoxycytidine	65
C <sub>23</sub> H <sub>21</sub> N <sub>3</sub> O <sub>6</sub>	N4,5'-O-Dibenzoyl-2'-deoxycytidine	233
	N4,3'-O-Dibenzoyl-2'-deoxycytidine	233
	N4-Benzoyl-5'-O-benzoyl-2'-deoxycytidine	94
C <sub>23</sub> H <sub>22</sub> N <sub>6</sub> O <sub>4</sub>	2'-Deoxy-8-(9H-fluoren-2-ylamino)-guanosine	190
C <sub>23</sub> H <sub>22</sub> BN <sub>5</sub> O <sub>6</sub> S	2',3'-Phenylboronate-5'-O-p-toluenesulfonyl adenosine	340
C <sub>23</sub> H <sub>23</sub> NaO <sub>4</sub>	8-(2-Amino-1-methyl-6-phenylimidazo[4,5-b]pyridyl)-2'-deoxyguanosine	58
C <sub>23</sub> H <sub>24</sub> N <sub>4</sub> O <sub>6</sub> S	6-[[4-Methylphenyl]thio]-2-oxo-9-(2',3',5'-tri-O-acetyl-b-D-ribofuranosyl)-2,3-dihydropurine	322
C <sub>23</sub> H <sub>25</sub> N <sub>5</sub> O <sub>7</sub> S	2-Amino-6-(4-methylphenyl)thio-9-(2',3',5'-tri-O-acetyl-b-D-ribofuranosyl)purine	59
C <sub>23</sub> H <sub>26</sub> D <sub>3</sub> NaO <sub>13</sub>	3'-Azido-3'-deoxythymidine-methyl-D3-2,3,4-tri-O-acetyl-b-D-glucuronide methyl ester	87
C <sub>23</sub> H <sub>27</sub> N <sub>7</sub> O <sub>14</sub> P <sub>2</sub>	Nicotinamide 1,N6-ethanoadenine dinucleotide	334
C <sub>23</sub> H <sub>28</sub> N <sub>7</sub> O <sub>6</sub> ·Na	4-[2-[6-Amino-9-(N-ethyl-b-D-ribofuranuronamidoyl)-9H-purin-2-yl]amino]ethyl]benzenepropanoic acid monosodium salt	54
C <sub>23</sub> H <sub>29</sub> N <sub>6</sub> O <sub>13</sub>	3'-Azido-3'-deoxythymidine 2,3,4-tri-O-acetyl-b-D-glucuronide methyl ester	87

# Formula Index

C<sub>29</sub>H<sub>44</sub>BrN<sub>5</sub>O<sub>5</sub>Si<sub>2</sub>

Formula	Product Name	Page
C <sub>23</sub> H <sub>30</sub> ClN <sub>7</sub> O <sub>6</sub>	2-p-(2-Carboxyethyl)phenethylamino-5'-N-ethylcarboxamidoadenosine hydrochloride	137
C <sub>23</sub> H <sub>31</sub> N <sub>5</sub> O <sub>5</sub> Si	N6-Benzoyl-2'-O-tert-butylidimethylsilyladenosine	94
C <sub>23</sub> H <sub>30</sub> ClN <sub>7</sub> O <sub>6</sub> ·xH <sub>2</sub> O	2-p-(2-Carboxyethyl)phenethylamino-5'-N-ethylcarboxamidoadenosine hydrochloride hydrate	137
C <sub>23</sub> H <sub>35</sub> Li <sub>3</sub> N <sub>7</sub> O <sub>17</sub> P <sub>3</sub> S	Acetyl coenzyme A trilithium salt	13
C <sub>23</sub> H <sub>38</sub> N <sub>7</sub> O <sub>17</sub> P <sub>3</sub> S·xLi	Acetyl coenzyme A lithium salt	12
C <sub>23</sub> H <sub>38</sub> N <sub>7</sub> O <sub>17</sub> P <sub>3</sub> S·xNa	Acetyl coenzyme A sodium salt	12
C <sub>23</sub> H <sub>41</sub> N <sub>5</sub> O <sub>7</sub> Si <sub>2</sub>	N-Acetyl-3',5'-O-(1,1,3,3-tetraisopropyl-1,3-disiloxanediyl)cytidine	20
	N4-Acetyl-3',5'-O-(1,1,3,3-tetraisopropyl-1,3-disiloxanediyl)cytidine	20
	N-Acetyl-3',5'-O-(1,1,3,3-tetraisopropyl-1,3-disiloxanediyl)adenosine	20
C <sub>11</sub> H <sub>16</sub> N <sub>6</sub> O <sub>6</sub> P·C <sub>12</sub> H <sub>32</sub> N <sub>2</sub>	2'-C-Methylguanosine 5'-monophosphate triethyl ammonium salt - Aqueous solution	317
C <sub>24</sub> H <sub>19</sub> ClFN <sub>5</sub> O <sub>5</sub>	2-Amino-6-chloro-9-(2-deoxy-3,5-di-O-benzoyl-2-fluoro-b-D-arabinofuranosyl)purine	40
C <sub>24</sub> H <sub>20</sub> NaO <sub>4</sub>	3'-Azido-N6-benzoyl-5'-O-benzoyl-2',3'-dideoxyadenosine	80
C <sub>24</sub> H <sub>21</sub> N <sub>5</sub> O <sub>5</sub>	N6,5'-O-Dibenzoyl-2'-deoxyadenosine	232
	N6,3'-O-Dibenzoyl-2'-deoxyadenosine	232
	N6-Benzoyl-5'-O-benzoyl-2'-deoxyadenosine	94
C <sub>24</sub> H <sub>21</sub> FN <sub>2</sub> O <sub>8</sub>	3',5'-Di-O-benzoyl-5-fluoro-2'-O-methyluridine	234
C <sub>24</sub> H <sub>22</sub> NeO <sub>4</sub>	3'-Amino-N4-benzoyl-5'-O-benzoyl-2',3'-dideoxyadenosine	36
C <sub>24</sub> H <sub>22</sub> FN <sub>3</sub> O <sub>6</sub>	5'-O-p-Anisoyl-N4-benzoyl-3'-fluoro-2',3'-dideoxycytidine	70
C <sub>24</sub> H <sub>22</sub> N <sub>2</sub> O <sub>7</sub>	1,5-Anhydro-3-O-benzoyl-4,6-O-benzylidene-2-deoxy-2-(uracil-1-yl)-D-alto-hexitol	65
	1,5-Anhydro-3-O-benzoyl-4,6-O-benzylidene-2-deoxy-2-(N4-benzoylcytidin-1-yl)-D-alto-hexitol	65
C <sub>24</sub> H <sub>22</sub> N <sub>7</sub> O <sub>13</sub> P <sub>3</sub> S <sub>2</sub> ·xNa	gamma-(BBT)-ATP	93
C <sub>24</sub> H <sub>22</sub> N <sub>7</sub> O <sub>14</sub> P <sub>3</sub> S <sub>2</sub> ·xNa	gamma-(BBT)-GTP	93
C <sub>24</sub> H <sub>23</sub> N <sub>3</sub> O <sub>6</sub>	5'-O-p-Anisoyl-N4-benzoyl-2',3'-dideoxycytidine	70
	2,3'-Anhydro-5'-O-p-anisoyl-N4-benzoyl-2'-deoxycytidine	64
C <sub>24</sub> H <sub>24</sub> N <sub>4</sub> O <sub>6</sub>	1-(2-Deoxy-3',5'-di-O-toluoyl-D-ribofuranosyl)-4-amino-1,3-dihydro-2-oxo-1,3,5-triazine	180
	1-(2-Deoxy-3',5'-di-O-toluoyl-b-D-ribofuranosyl)-4-amino-1,2-dihydro-2-oxo-1,3,5-triazine	180
	1-(2-Deoxy-3',5'-di-O-toluoyl-a-D-ribofuranosyl)-4-amino-1,2-dihydro-2-oxo-1,3,5-triazine	180
	3'-Amino-5'-O-p-anisoyl-N4-benzoyl-2',3'-dideoxycytidine	36
C <sub>24</sub> H <sub>27</sub> BF <sub>2</sub> N <sub>6</sub> Na <sub>3</sub> O <sub>13</sub> P <sub>3</sub> S	Adenosine 5'-O-(3-thiotriphosphate), BODIPY FL thioester sodium salt - 5mM buffered aqueous solution	26
C <sub>24</sub> H <sub>24</sub> N <sub>5</sub> O <sub>15</sub> P <sub>3</sub> ·xNH <sub>3</sub>	2'(3')-O-(4-Benzoyl)benzoyladenosine-5'-triphosphate triethylammonium salt	94
C <sub>24</sub> H <sub>38</sub> N <sub>7</sub> O <sub>19</sub> P <sub>3</sub> S·xLi	Malonyl coenzyme A lithium salt - 97%	304
	Malonyl coenzyme A lithium salt - 90%	303
C <sub>24</sub> H <sub>38</sub> N <sub>7</sub> O <sub>17</sub> P <sub>3</sub> SLi	Propionyl coenzyme A lithium salt	344
C <sub>24</sub> H <sub>41</sub> N <sub>6</sub> O <sub>17</sub> P <sub>3</sub> S·4Li	Biotin-11-2-deoxyuridine-5-triphosphate tetralithium salt	119
C <sub>24</sub> H <sub>17</sub> Cl <sub>2</sub> FN <sub>4</sub> O <sub>5</sub>	2,6-Dichloro-9-(3',5'-di-O-benzoyl-2'-deoxy-2'-fluoro-b-D-arabinofuranosyl)purine	236
C <sub>24</sub> H <sub>18</sub> ClFN <sub>4</sub> O <sub>5</sub>	6-Chloro-9-(3',5'-di-O-benzoyl-2'-Deoxy-2'-fluoro-b-D-arabinofuranosyl)purine	145
C <sub>25</sub> H <sub>22</sub> Cl <sub>2</sub> N <sub>2</sub> O <sub>7</sub>	5-Ethyl-3',5'-bis-(p-chlorobenzoyl)-2'-deoxyuridine	271
C <sub>25</sub> H <sub>23</sub> N <sub>3</sub> O <sub>4</sub>	1,5-Anhydro-4,6-O-benzylidene-2,3-dideoxy-2-(N6-benzoyl-adenin-1-yl)-D-glucitol	66
C <sub>25</sub> H <sub>23</sub> N <sub>5</sub> O <sub>6</sub>	5'-O-p-Anisoyl-N6-benzoyl-2'-deoxyadenosine	70
C <sub>25</sub> H <sub>23</sub> N <sub>2</sub> O <sub>7</sub>	2'-Deoxy-5-iodo-3',5'-di-O-p-toluoyluridine	209
C <sub>25</sub> H <sub>27</sub> N <sub>3</sub> O <sub>5</sub> S	Tert-Butyl-2-Phenyl-4-(P-Tolylsulfonyloxy)-7,8-Dihydropyrido[4,3-D]Pyrimidine-6(5H)-Carboxylate	354
C <sub>25</sub> H <sub>36</sub> N <sub>7</sub> O <sub>18</sub> P <sub>3</sub> SLi <sub>4</sub> ·5H <sub>2</sub> O	Acetoacetyl coenzyme A lithium salt	10
C <sub>25</sub> H <sub>37</sub> N <sub>7</sub> Na <sub>3</sub> O <sub>18</sub> P <sub>3</sub> S·3H <sub>2</sub> O	Acetoacetyl coenzyme A trisodium salt trihydrate	10
C <sub>25</sub> H <sub>42</sub> N <sub>6</sub> O <sub>13</sub> P <sub>2</sub> S <sub>1</sub>	Cytidine-5'-phosphate-3'-(6-aminoethyl)phosphate-biotin triethylammonium salt - 1 mM aqueous solution (10 mM Tris-HCl)	161

Formula	Product Name	Page
C <sub>26</sub> H <sub>23</sub> ClN <sub>4</sub> O <sub>5</sub>	3,5-Di-O-toluoyl 6-chloropurine-7-b-D-deoxyriboside	254
	6-Chloro-9-(2'-deoxy-3',5'-di-O-toluoyl-b-ribofuranosyl)purine	143
C <sub>26</sub> H <sub>24</sub> ClN <sub>5</sub> O <sub>5</sub>	2-Amino-6-chloro-9-(2'-deoxy-3',5'-di-O-toluoyl-b-D-ribofuranosyl)purine	40
C <sub>26</sub> H <sub>37</sub> Cl <sub>2</sub> NeO <sub>9</sub> P	(4-N,N-(Dipropyl-1,1-dichloro-2-aminophenyl)(5'-deoxy-5'-glycylamino-2'-O-tetrahydropyranilylcytidyl-3')hydrogen phosphate	253
C <sub>26</sub> H <sub>42</sub> N <sub>4</sub> O <sub>5</sub>	Sapacitabine	353
C <sub>26</sub> H <sub>45</sub> N <sub>5</sub> O <sub>7</sub> Si <sub>2</sub>	N2-Isobutyl-3',5'-O-(1,1,3,3-tetraisopropyl-1,3-disiloxanediyl)guanosine	297
C <sub>27</sub> H <sub>27</sub> N <sub>3</sub> O <sub>7</sub>	6-(2-Deoxy-3,5-di-O-toluoyl-b-D-ribofuranosyl)-3,4-dihydro-8H-pyrimido[4,5-c][1,2]oxazin-7-one	180
C <sub>27</sub> H <sub>31</sub> Na <sub>3</sub> Ne <sub>2</sub> O <sub>15</sub> P <sub>2</sub> ·xH <sub>2</sub> O	Riboflavin 5'-adenosine diphosphate disodium salt hydrate	350
C <sub>27</sub> H <sub>43</sub> F <sub>2</sub> N <sub>3</sub> O <sub>5</sub>	Gemcitabine 5'-elaidate	281
C <sub>28</sub> H <sub>23</sub> FN <sub>2</sub> O <sub>4</sub>	1-(2',3'-Dideoxy-2',3'-didehydro-2'-fluoro-5'-O-trityl-b-L-ribofuranosyl)-uracil	241
C <sub>28</sub> H <sub>24</sub> N <sub>2</sub> O <sub>6</sub>	2'-Deoxy-5'-O-pixyluridine	218
C <sub>28</sub> H <sub>25</sub> FN <sub>2</sub> O <sub>5</sub>	1-(2'-Deoxy-2'-fluoro-5'-O-trityl-b-L-arabinofuranosyl)-uracil	202
C <sub>28</sub> H <sub>26</sub> N <sub>2</sub> O <sub>5</sub>	3'-Deoxy-5'-O-trityluridine	223
	2'-Deoxy-5'-O-trityluridine	223
C <sub>28</sub> H <sub>26</sub> N <sub>2</sub> O <sub>6</sub>	5'-O-Trityluridine	378
C <sub>28</sub> H <sub>28</sub> NeO <sub>6</sub>	1,5-Anhydro-3-O-benzoyl-4,6-O-benzylidene-2-deoxy-2-(N8-(dimethylamino)methyleneguanidin-1-yl)-D-alto-hexitol	65
C <sub>28</sub> H <sub>33</sub> FN <sub>2</sub> O <sub>6</sub> Si	3'-O-Acetyl-5'-O-tert-butylidiphenylsilyl-2'-deoxy-2'-fluorothymidine	12
C <sub>28</sub> H <sub>37</sub> N <sub>9</sub> O <sub>5</sub> S	8-Amino-11'-(N''-dansyl)-4'-aminobutyl]-5'-(1-aziridinyl)-5'-deoxy adenosine	44
C <sub>28</sub> H <sub>41</sub> N <sub>3</sub> O <sub>11</sub> Si <sub>2</sub>	3',5'-O-(1,1,3,3-Tetraisopropyl-1,3-disiloxanediyl)-2'-(p-nitrophenylcarboxyloxy)uridine	356
C <sub>28</sub> H <sub>43</sub> N <sub>3</sub> O <sub>7</sub> Si <sub>2</sub>	N4-Benzoyl-3',5'-O-(1,1,3,3-tetraisopropyl-1,3-disiloxanediyl)cytidine	113
C <sub>28</sub> H <sub>44</sub> N <sub>8</sub> O <sub>5</sub>	5'-O-Acetyl-3'-azido-2',3'-dideoxy-N2-palmitoylguanosine	11
C <sub>28</sub> H <sub>45</sub> N <sub>6</sub> O <sub>18</sub> P <sub>3</sub> S·xLi	Biotin-11-uridine-5'-triphosphate, lithium salt - 1 mM aqueous solution	119
C <sub>28</sub> H <sub>46</sub> N <sub>7</sub> O <sub>16</sub> P <sub>3</sub> S	Biotin-11-deoxycytidine-5'-triphosphate, lithium salt - 1 mM aqueous solution	118
C <sub>28</sub> H <sub>46</sub> N <sub>7</sub> O <sub>17</sub> P <sub>3</sub> S·xLi	Biotin-11-cytidine-5'-triphosphate lithium salt - 1mM aqueous solution	118
C <sub>29</sub> H <sub>21</sub> Cl <sub>3</sub> N <sub>4</sub> O <sub>8</sub>	2',3',5'-Tri-O-(p-chlorobenzoyl)-5-azacytidine	375
C <sub>29</sub> H <sub>25</sub> N <sub>2</sub> O <sub>5</sub> D <sub>3</sub>	5'-O-Trityl-D3-thymidine	378
C <sub>29</sub> H <sub>26</sub> N <sub>2</sub> O <sub>4</sub>	5'-O-Trityl-2,3'-anhydrothymidine	378
	2',3'-Dehydro-5'-O-tritylthymidine	171
	2,3'-Anhydro-5'-O-tritylthymidine	69
C <sub>29</sub> H <sub>26</sub> N <sub>3</sub> O <sub>4</sub> D <sub>3</sub>	3'-Amino-3'-deoxy-5'-O-trityl-D3-thymidine	49
C <sub>29</sub> H <sub>26</sub> N <sub>2</sub> O <sub>6</sub>	5'-O-Pixylthymidine	342
C <sub>29</sub> H <sub>27</sub> ClN <sub>2</sub> O <sub>4</sub>	3'-Chloro-3'-deoxy-5'-O-tritylthymidine	144
C <sub>29</sub> H <sub>27</sub> FN <sub>2</sub> O <sub>4</sub>	3'-Deoxy-3'-fluoro-5'-O-tritylthymidine	203
C <sub>29</sub> H <sub>27</sub> N <sub>5</sub> O <sub>4</sub>	3'-Azido-3'-deoxy-5'-O-tritylthymidine	88
C <sub>29</sub> H <sub>27</sub> FN <sub>2</sub> O <sub>6</sub>	1-(2-Deoxy-5'-O-MMT-b-D-threo-pentofuranosyl)-5-fluorouracil	217
C <sub>29</sub> H <sub>28</sub> N <sub>2</sub> O <sub>5</sub>	5'-O-Tritylthymidine	378
C <sub>29</sub> H <sub>28</sub> N <sub>2</sub> O <sub>6</sub>	5'-O-Trityl-3'-b-hydroxythymidine	378
	2'-Deoxy-5'-O-MMT-uridine	217
C <sub>29</sub> H <sub>29</sub> N <sub>3</sub> O <sub>4</sub>	7-Hydroxymorpholino T monomer	290
C <sub>29</sub> H <sub>29</sub> N <sub>5</sub> O <sub>6</sub>	4-Amino-2,6-dimethyl-8-(2-deoxy-3',5'-di-O-toluoyl-D-ribofuranosyl)-7-pteridone	53
	4-Amino-2,6-dimethyl-8-(2-deoxy-3',5'-di-O-toluoyl-a-D-ribofuranosyl)-7-pteridone	52
C <sub>29</sub> H <sub>29</sub> HsO <sub>6</sub>	4-Amino-2,6-dimethyl-8-(2-deoxy-3',5'-di-O-toluoyl-b-D-ribofuranosyl)-7-pteridone	53
C <sub>29</sub> H <sub>38</sub> N <sub>10</sub> O <sub>15</sub> P <sub>2</sub>	Riboflavin 5'-(trihydrogen diphosphate) P'→5'-ester with N-(2-Aminoethyl)adenosine	350
C <sub>29</sub> H <sub>43</sub> N <sub>5</sub> O <sub>6</sub> Si <sub>2</sub>	N6-Benzoyl-3',5'-O-(1,1,3,3-tetraisopropyl-1,3-disiloxanediyl)adenosine	113
C <sub>29</sub> H <sub>44</sub> BrN <sub>5</sub> O <sub>5</sub> Si <sub>2</sub>	O6-Benzyl-8-bromo-3',5'-O-(1,1,3,3-tetrakis(isopropyl)-1,3-disiloxanediyl)-2'-deoxyguanine	115

Formula	Product Name	Page
C29H50N7O17P3S	Octanoyl coenzyme A	337
C29H53N5O4Si3	1-(2',3',5'-Tri-O-tert-butylidimethylsilyl-b-D-ribofuranosyl)-5-ethynylimidazo-4-carbonitrile	375
C29H56N4O4Si3	4-Amino-1-(2',3',5'-tri-O-tert-butylidimethylsilyl-b-D-ribofuranosyl)-imidazo[4,5-c]pyridine	63
C11H16N5O11P2·C18H45N3	2'-C-Methylguanosine 5'-diphosphate triethylammonium salt	317
C30H42N2O6S	2',3',5'-Tri-O-benzoyl-2-thiouridine	374
C30H42N2O6	2',3',5'-Tri-O-benzoyluridine	374
C30H26N4O4	2'-Deoxy-5'-O-pixylinosine	218
C30H26N5O5D3	3'-Azido-3'-deoxy-5'-O-MMT-D3-thymidine	86
C30H28N3O5D3	3'-Amino-3'-deoxy-5'-O-MMT-D3-thymidine	47
C30H28N2O7	5'-O-DMT-2,2'-anhydrouridine	255
C30H29N3O5	N4-Acetyl-5'-O-Tritylcytidine	21
C30H29N4O5	N4-Acetyl-2'-deoxy-5'-O-tritylcytidine	17
C30H29BrN2O7	5-Bromo-2'-deoxy-5'-O-DMT-uridine	124
C30H29FN2O7	2'-Deoxy-5'-O-DMT-5-fluorouridine	184
C30H29F2N2O7	2'-Deoxy-5'-O-DMT-2'-fluorouridine	184
	2'-Deoxy-5'-O-DMT-2'-fluoro-L-uridine	184
	1-(2'-Deoxy-5'-O-DMT-2'-fluoro-b-D-arabinofuranosyl)uracil	182
C30H29N2O7	2'-Deoxy-5'-O-DMT-5-iodouridine	185
C30H30N2O6	5'-O-MMT-thymidine	329
C30H30N3O6	5'-O-(4,4'-dimethoxytrityl)-2'-deoxycytidine	249
C30H30FN3O6	2'-Deoxy-5'-O-DMT-2'-fluorocytidine	183
C30H30N4O6	2',3'-Dideoxy-5'-O-DMT-uridine	241
C30H30N2O7	2'-Deoxy-5'-O-DMT-uridine	189
C30H30N2O8	5'-O-DMT-4-thiouridine	263
	5'-O-DMT-2-thiouridine	263
C30H30N2O8	5'-O-DMT-uridine	265
C30H40N8O6S	N6-Dansylhexyl-5'-ethylcarboxamidoadenosine	163
C30H41N7O6	2-[4-(2-(tert-Butoxycarbonyl)ethyl)phenylethyl]amino]2',3'-O-isopropylideneadenosine-5'-N-ethylcarboxamide	129
C30H45N6O6Si2	N2-Phenoxyacetyl-3',5'-O-(1,1,3,3-tetraisopropyl-1,3-disiloxanediyl)guanosine	339
C31H25N5O7	2',3'-Di-O-benzoyl-N6-benzoyl-L-adenosine	232
C31H25N5O8	2',3',5'-Tri-O-benzoylguanosine	373
C31H25NO9	2',3',5'-Tri-O-benzoyl-3-deazaauridine	373
C31H26FN3O7	(2'R)-N-Benzoyl-2'-deoxy-2'-fluoro-2'-methylcytidine 3',5'-d	104
C31H26N2O9	2',3',5'-Tri-O-benzoyl-6-methyluridine	374
	2',3',5'-Tri-O-benzoyl-2'-C-methyluridine	374
C31H27N3O8	2',3',5'-Tri-O-benzoyl-2'-C-methylcytidine	373
C31H28N5O7D3	3'-Azido-3'-deoxy-5'-O-DMT-D3-thymidine	85
C31H29FN4O6	5'-O-DMT-2'-fluoro-2'-deoxyinosine	256
C31H30N2O6	5'-O-DMT-2,3'-anhydrothymidine	255
C31H30N4O6	5'-O-(4,4'-Dimethoxytrityl)-2'-deoxyinosine	250
	2'-Deoxy-5'-O-DMT-inosine	185
C31H30N4O7	5'-O-DMT-inosine	258
C31H31N5O4	9-(2',3',5'-Tri-O-benzyl-b-D-arabinofuranosyl)adenine	374
C31H31N5O5	5'-O-(4,4'-dimethoxytrityl)-2'-deoxyadenosine	249
C31H31N5O6	3'-Azido-2'-deoxy-5'-O-DMT-thymidine	84
C31H31N2O7	2'-Deoxy-5'-O-DMT-2'-fluoro-5-methyluridine	183
C31H31FN2O7	1-(2'-Deoxy-5'-O-DMT-2'-fluoro-b-D-arabinofuranosyl)thymine	182
C31H32N2O7	5'-O-DMT-thymidine	264
	3'-O-DMT-thymidine	264
	1-(2'-Deoxy-5'-O-DMT-b-D-lyxofuranosyl)thymine	187
C31H32N2O8	5'-O-DMT-2'-O-methyluridine	261
C31H33N3O6	2'-Deoxy-5'-O-DMT-5-methylcytidine	187
	3'-Amino-3'-deoxy-5'-O-DMT-thymidine	46
C31H33N3O7	5'-O-DMT-2'-O-methylcytidine	260
C31H34ClN4O5P	[(2S,6R)-6-(Thymin-1-yl)-4-tritylmorpholin-2-yl]methyl dimethyl-phosphoramidochloridate	366
C31H55N3O6	Enocitabine	267
C31H54N7O17P3S·H2O	Decanoyl coenzyme A, free acid	170
C32H27N5O6	1,5-Anhydro-3-O-benzoyl-4,6-O-benzylidene-2-deoxy-2-(N6-benzoyladenine-1-yl)-D-alto-hexitol	65
C32H27N5O7	6-Amino-9-(2',3',5'-tri-O-benzoyl-2'-C-methyl-b-D-ribofuranosyl)purine	63
C32H30F3N3O8	2'-Deoxy-5'-O-DMT-2'-trifluoroacetamidouridine	189

Formula	Product Name	Page
C32H31N3O7	7-Deaza-2'-deoxy-5'-O-DMT-xanthosine	165
C32H31FN2O8	3'-O-Acetyl-2'-deoxy-5'-O-DMT-2'-fluorouridine	185
C32H32N6O4	2'-Deoxy-N2-DMF-5'-O-tritylguanosine	181
C32H32FN3O7	N4-Acetyl-2'-deoxy-5'-O-DMT-2'-fluorocytidine	15
C32H32N3O7	N4-Acetyl-2'-deoxy-5'-O-DMT-5-iodocytidine	15
C32H32N4O7	5'-O-DMT-2'-O-methylinosine	260
C32H32N5O8	N4-Acetyl-5'-O-DMT-5-iodocytidine	18
C32H33N5O4	(1S,2S,3S,5S)-5-(2-Amino-6-(benzyloxy)-9H-purin-9-yl)-3-(benzyloxy)-2-(benzyloxymethyl)cyclopentanol	38
C32H33N5O5	2'-Deoxy-5'-O-DMT-N6-methyladenosine	187
C32H33N3O7	N4-Acetyl-2'-deoxy-5'-O-DMT-cytidine	15
C32H33N5O7	5'-O-DMT-2'-O-methyl-5-methyluridine	260
C32H34N2O8	5'-O-DMT-N4-ethylcytidine	18
C32H34N3O8	6-(2-Deoxy-5'-O-DMT-b-D-ribofuranosyl)-3,4-dihydro-8H-pyrimido-[4,5-c][1,2]oxazin-7-one	188
C32H42N10O15P2·2Na	N6-Aminohexyl-flavin adenine dinucleotide	55
C32H52N7O18P3S·xLi	Biotin-16-deoxyuridine-5'-triphosphate, lithium salt - 1 mM aqueous solution	119
C32H52NaO18P3S	Biotin-16-cytidine-5'-triphosphate lithium salt - 1 mM aqueous solution	118
C32H52N7O19P3S·xLi	Biotin-16-uridine-5'-triphosphate, lithium salt - 1 mM aqueous solution	120
C32H53NaO17P3S	Biotin-16-deoxycytidine-5'-triphosphate, lithium salt - 1 mM aqueous solution	119
C33H31N5O6	N2-Isobutyryl-2'-deoxy-5'-O-pixylguanosine	296
C33H32N5O6	N2-Isobutyryl-5'-O-Trt-guanosine	297
C33H32N5O8	2'-Deoxy-5'-O-DMT-5-propargyloxuridine	188
C33H33N5O5	2'-Deoxy-N2-isobutyryl-5'-O-tritylguanosine	212
C33H33N5O6	N6-Acetyl-2'-deoxy-5'-O-DMT-adenosine	14
	N6-Acetyl-2'-deoxy-5'-O-DMT-adenosine	14
C33H34N6O5	2'-Deoxy-N2-DMF-5'-O-MMT-guanosine	181
C33H34N2O9	3'-O-Acetyl-5'-O-DMT-2'-O-methyluridine	19
C33H35N3O7	N4-Acetyl-2'-deoxy-5'-O-DMT-5-methylcytidine	15
C33H35N3O8	N4-Acetyl-5'-O-DMT-2'-O-methylcytidine	18
C33H36N4O6	5'-O-DMT-N-(dimethylamino)methylidene-2'-deoxypseudoisocytidine	255
C33H36N2O9	5'-O-DMT-2'-O-(2-methoxyethyl)uridine	260
C33H53N7O19P3S	Biotin-18-uridine-5'-triphosphate triethylammonium salt - 5mM aqueous solution	120
C33H58N7O17P3S	Lauroyl coenzyme A	302
C9H14F2N3O13P3·C24H60N4	2'-Deoxy-2',2'-difluorocytidine 5'-triphosphate triethylammonium salt - Aqueous solution	178
C34H32N2O7	2-Deoxy-1-(5'-O-DMT-b-D-ribofuranosyl)-5-nitroindole	189
C34H34N2O9	E-5-(2-Carbomethoxyvinyl)-2'-deoxy-5'-O-DMT-uridine	136
C34H35N5O6	2'-Deoxy-N2-isobutyryl-5'-O-MMT-guanosine	212
C34H35FN6O6	5'-O-DMT-N2-Dimethylformamid-2'-deoxy-2'-fluoroguanosine	256
C34H36N6O5	2'-Deoxy-6N-DMF-5'-O-DMT-adenosine	180
	8-Aza-7-deaza-2'-deoxy-N2-DMF-5'-O-DMT	77
C34H36N6O6	5'-O-DMT-N2-DMF-3'-deoxyguanosine	256
	3'-Deoxy-N2-DMF-5'-O-DMT-guanosine	181
	2'-Deoxy-N2-DMF-5'-O-DMT-guanosine	181
C34H36N6O7	5'-O-DMT-N2-DMF-guanosine	256
C34H37N5O6	2'-Deoxy-5'-O-DMT-N2-isopropylguanosine	187
C34H37N3O7	2'-Deoxy-5'-O-DMT-N4-isobutyrylcytidine	186
C34H37N3O8	N4-Acetyl-5'-O-DMT-2'-O-methyl-5-methylcytidine	19
C34H38N2O9	5'-O-DMT-2'-O-(2-methoxyethyl)-5-methyluridine	259
C34H40N2O6Si	2'-O-tert-Butyldimethylsilyl-3'-deoxy-5'-O-trityluridine	130
C34H40N2O6Si	2'-O-tert-Butyldimethylsilyl-5'-O-trityluridine	130
C34H55N8O18P3S	Biotin-18-cytidine-5'-triphosphate triethylammonium salt - 5mM aqueous solution	118
C34H56N7O18P3S	Biotin-11-deoxyuridine-5'-triphosphate, triethylammonium salt - 1 mM aqueous solution	119
C35H29N3O6	N4-Benzoyl-2'-deoxy-5'-O-pixylcytidine	106
C35H31N3O5	N4-Benzoyl-2'-deoxy-5'-O-tritylcytidine	107

# Formula Index

C<sub>40</sub>H<sub>41</sub>N<sub>5</sub>O<sub>9</sub>

Formula	Product Name	Page
C <sub>35</sub> H <sub>31</sub> N <sub>3</sub> O <sub>6</sub>	N4-Benzoyl-5'-O-Trityl-cytidine	114
C <sub>35</sub> H <sub>31</sub> N <sub>3</sub> O <sub>5</sub> S	1-(3'-O-Nosyl-5'-O-trityl-2'-deoxy-b-D-lyxofuranosyl)thymine	336
C <sub>35</sub> H <sub>32</sub> N <sub>4</sub> O <sub>4</sub>	N4-Benzoyl-7-hydroxymorpholino cytidine monomer	110
C <sub>35</sub> H <sub>36</sub> FN <sub>5</sub> O <sub>7</sub>	2'-Deoxy-5'-O-DMT-2'-fluoro-N2-isobutyrylguanosine	183
	9-(2'-Deoxy-5'-O-DMT-2'-fluoro-b-D-arabinofuranosyl)-N2-isobutyrylguanine	182
C <sub>35</sub> H <sub>36</sub> N <sub>2</sub> O <sub>10</sub>	5'-O-DMT-thymidine-3'-O-succinic acid	263
C <sub>35</sub> H <sub>37</sub> N <sub>5</sub> O <sub>6</sub>	2'-Deoxy-5'-O-DMT-N6-isobutyrylguanosine	185
C <sub>35</sub> H <sub>37</sub> N <sub>5</sub> O <sub>7</sub>	2'-Deoxy-5'-O-DMT-N2-isobutyrylguanosine	186
	2'-Deoxy-5'-O-DMT-N2-isobutyryl-a-guanosine	186
	2'-Deoxy-3'-O-DMT-N2-isobutyrylguanosine	186
C <sub>35</sub> H <sub>37</sub> N <sub>5</sub> O <sub>8</sub>	5'-O-DMT-N2-isobutyrylguanosine	259
	5'-O-DMT-N2-isobutyryl-9-(b-D-arabinofuranosyl)guanine	258
C <sub>35</sub> H <sub>38</sub> N <sub>6</sub> O <sub>6</sub>	3'-Amino-2',3'-dideoxy-5'-O-DMT-N2-isobutyrylguanosine	50
C <sub>35</sub> H <sub>38</sub> N <sub>6</sub> O <sub>7</sub>	N2-DMF-5'-O-DMT-2'-O-methylguanosine	254
C <sub>35</sub> H <sub>38</sub> N <sub>4</sub> O <sub>8</sub>	5-[N-(2-Aminoethyl)-3-E-acrylamido]-2'-deoxy-5'-O-DMT-uridine	53
C <sub>35</sub> H <sub>39</sub> N <sub>3</sub> O <sub>8</sub>	5'-O-DMT-N4-isobutyryl-2'-O-methylcytidine	259
C <sub>35</sub> H <sub>62</sub> N <sub>7</sub> O <sub>17</sub> P <sub>3</sub> S·xLi	Myristoyl coenzyme A lithium salt	329
C <sub>35</sub> H <sub>62</sub> N <sub>7</sub> O <sub>17</sub> P <sub>3</sub> S·H <sub>2</sub> O	Myristoyl coenzyme A	330
C <sub>35</sub> H <sub>79</sub> N <sub>9</sub> O <sub>13</sub> P <sub>3</sub>	2'-C-Methyladenosine 5'-triphosphate triethyl ammonium salt - Aqueous solution	310
C <sub>36</sub> H <sub>29</sub> N <sub>5</sub> O <sub>5</sub>	N6-Benzoyl-2'-deoxy-5'-O-pixyladenosine	106
C <sub>36</sub> H <sub>30</sub> N <sub>6</sub> O <sub>3</sub>	3'-Azido-N4-benzoyl-5'-O-trityl-2',3'-dideoxyadenosine	82
C <sub>36</sub> H <sub>31</sub> N <sub>5</sub> O <sub>4</sub>	N6-Benzoyl-5'-O-2'-deoxyadenosine	97
C <sub>36</sub> H <sub>31</sub> N <sub>5</sub> O <sub>5</sub>	N6-Benzoyl-5'-O-trityl-adenosine	114
C <sub>36</sub> H <sub>32</sub> N <sub>6</sub> O <sub>3</sub>	N6-Benzoyl-7-hydroxymorpholino adenosine monomer	110
C <sub>36</sub> H <sub>38</sub> N <sub>4</sub> O <sub>7</sub>	7-Deaza-2'-deoxy-5'-O-DMT-N2-isobutyrylguanosine	165
C <sub>36</sub> H <sub>39</sub> N <sub>5</sub> O <sub>8</sub>	5'-O-DMT-N2-isobutyryl-2'-O-methylguanosine	259
C <sub>36</sub> H <sub>41</sub> N <sub>3</sub> O <sub>8</sub>	5'-O-DMT-N4-isobutyryl-2'-O-methyl-5-methylcytidine	259
C <sub>36</sub> H <sub>42</sub> N <sub>6</sub> O <sub>6</sub>	5'-O-DMT-2'-O-pentylaminoadenosine	262
C <sub>36</sub> H <sub>42</sub> N <sub>2</sub> O <sub>8</sub>	5'-O-DMT-5-methyl-2'-O-pentyluridine	261
C <sub>36</sub> H <sub>44</sub> N <sub>2</sub> O <sub>6</sub> Si	3'-O-tert-Butyldimethylsilyl-5'-O-DMT-uridine	132
	2'-O-tert-Butyldimethylsilyl-5'-O-DMT-uridine	132
C <sub>37</sub> H <sub>32</sub> N <sub>6</sub> O <sub>4</sub>	3'-Azido-N6-benzoyl-5'-O-MMT-2',3'-dideoxyadenosine	82
C <sub>37</sub> H <sub>34</sub> N <sub>6</sub> O <sub>6</sub>	2'-Azido-N4-benzoyl-2',3'-dideoxy-5'-O-DMT-cytidine	81
C <sub>37</sub> H <sub>34</sub> FN <sub>3</sub> O <sub>7</sub>	N4-Benzoyl-2'-deoxy-5'-O-DMT-2'-fluorocytidine	103
	N4-Benzoyl-1-(2'-deoxy-5'-O-DMT-2'-fluoro-b-D-arabinofuranosyl)cytosine	102
C <sub>37</sub> H <sub>34</sub> N <sub>6</sub> O <sub>7</sub>	2'-Azido-N4-benzoyl-2'-deoxy-5'-O-DMT-cytidine	81
C <sub>37</sub> H <sub>34</sub> N <sub>2</sub> O <sub>6</sub> S	2'-O-Benzoyl-5'-O-DMT-4-thiouridine	109
C <sub>37</sub> H <sub>35</sub> N <sub>3</sub> O <sub>7</sub>	N4-Benzoyl-3'-deoxy-5'-O-DMT-cytidine	101
	N4-Benzoyl-2'-deoxy-5'-O-DMT-cytidine	101
	N4-Benzoyl-2'-deoxy-5'-O-DMT-a-cytidine	101
C <sub>37</sub> H <sub>35</sub> N <sub>3</sub> O <sub>8</sub>	N4-Benzoyl-5'-O-DMT-cytidine	108
C <sub>37</sub> H <sub>35</sub> N <sub>3</sub> O <sub>11</sub> S	1-(2'-Deoxy-5'-O-DMT-3'-O-nitrophenylsulphonyl-b-D-lyxofuranosyl)thymine	188
C <sub>37</sub> H <sub>36</sub> N <sub>4</sub> O <sub>6</sub>	3'-Amino-N4-benzoyl-2',3'-dideoxy-5'-O-DMT-cytidine	37
C <sub>37</sub> H <sub>37</sub> ClN <sub>5</sub> O <sub>5</sub> P	[(2S,6R)-6-(N4-Benzoylcydin-1-yl)-4-tritylmorpholin-2-yl]methyl dimethyl-phosphoramidochloridate	96
C <sub>37</sub> H <sub>37</sub> F <sub>3</sub> N <sub>4</sub> O <sub>9</sub>	5'-O-DMT-5-[N-(2-(trifluoroacetamido)ethyl)-3-E-acrylamido]-2'-deoxyuridine	265
C <sub>37</sub> H <sub>40</sub> N <sub>5</sub> O <sub>18</sub> P <sub>3</sub>	5-Aminoallyl-2'-deoxyuridine 5'-triphosphate, labeled with 5/6-TAMRA - 1mM aqueous solution	34
C <sub>37</sub> H <sub>44</sub> N <sub>6</sub> O <sub>6</sub>	5'-O-DMT-2'-O-hexylaminoadenosine	257
C <sub>37</sub> H <sub>45</sub> N <sub>3</sub> O <sub>6</sub>	5'-O-DMT-2'-O-hexylamino-5-methyluridine	257
C <sub>37</sub> H <sub>48</sub> N <sub>3</sub> O <sub>5</sub> P	5'-O-DMT-thymidine 3'-H phosphonate triethylammonium salt	263
C <sub>37</sub> H <sub>65</sub> N <sub>7</sub> O <sub>17</sub> P <sub>3</sub> SK	Palmitoyl coenzyme A potassium salt	338
C <sub>19</sub> H <sub>26</sub> N <sub>5</sub> O <sub>11</sub> P <sub>3</sub> ·C <sub>18</sub> H <sub>48</sub> N <sub>3</sub>	N6-Benzyladenosine triphosphate triethylammonium salt	114

Formula	Product Name	Page
C <sub>38</sub> H <sub>34</sub> N <sub>6</sub> O <sub>5</sub>	3'-Azido-N6-benzoyl-5'-O-DMT-2',3'-dideoxyadenosine	82
C <sub>38</sub> H <sub>34</sub> FN <sub>6</sub> O <sub>6</sub>	N6-Benzoyl-2'-deoxy-5'-O-DMT-2'-fluoroadenosine	102
C <sub>38</sub> H <sub>34</sub> N <sub>6</sub> O <sub>6</sub>	3'-Azido-N6-benzoyl-2'-O-tert-butylidimethylsilyl-5'-O-DMT-adenosine	80
C <sub>38</sub> H <sub>35</sub> N <sub>5</sub> O <sub>6</sub>	N2-Benzoyl-9-(2'-deoxy-5'-O-DMT-2'-deoxy-b-D-ribofuranosyl)purine	101
	N6-Benzoyl-3'-deoxy-5'-O-DMT-adenosine	100
	N6-Benzoyl-2'-deoxy-5'-O-DMT-adenosine	100
	N6-Benzoyl-2'-deoxy-5'-O-DMT-a-adenosine	99
	8-Aza-N6-benzoyl-7-deaza-2'-deoxy-5'-O-DMT-adenosine	76
C <sub>38</sub> H <sub>35</sub> N <sub>5</sub> O <sub>7</sub>	N6-Benzoyl-5'-O-DMT-adenosine	107
	N6-Benzoyl-2'-deoxy-5'-O-DMT-8-oxo-adenosine	104
	N2-Benzoyl-2'-deoxy-5'-O-DMT-guanosine	103
	2-Amino-benzoyl-9-(5'-O-DMT-b-D-ribofuranosyl)purine	37
C <sub>38</sub> H <sub>36</sub> N <sub>6</sub> O <sub>5</sub>	N6-Benzoyl-3'-N-DMT-2',3'-dideoxyadenosine	108
	3'-Amino-N6-benzoyl-2',3'-dideoxy-5'-O-DMT-adenosine	37
C <sub>38</sub> H <sub>36</sub> FN <sub>3</sub> O <sub>7</sub>	N4-Benzoyl-2'-deoxy-5'-O-DMT-2'-fluoro-5-methylcytidine	103
	N4-Benzoyl-1-(2'-deoxy-5'-O-DMT-2'-fluoro-b-D-arabinofuranosyl)-5-methylcytosine	103
C <sub>38</sub> H <sub>37</sub> ClN <sub>7</sub> O <sub>4</sub> P	[(2S,6R)-6-(N6-Benzoyl-adenin-9-yl)-4-tritylmorpholin-2-yl]methyl dimethyl-phosphoramidochloridate	93
C <sub>38</sub> H <sub>37</sub> N <sub>3</sub> O <sub>7</sub>	5'-O-(4,4'-Dimethoxytrityl)-N4-benzoyl-5-methyl-2'-deoxycytidine	249
	N4-Benzoyl-2'-deoxy-5'-O-DMT-5-methylcytidine	103
C <sub>38</sub> H <sub>37</sub> N <sub>3</sub> O <sub>8</sub>	N4-Benzoyl-5'-O-DMT-5-methylcytidine	109
	N4-Benzoyl-5'-O-DMT-2'-O-methylcytidine	109
C <sub>38</sub> H <sub>40</sub> N <sub>6</sub> O <sub>7</sub>	6-O-(2-Cyanoethyl)-2'-deoxy-5'-O-DMT-N2-isobutyrylguanosine	156
C <sub>38</sub> H <sub>40</sub> N <sub>2</sub> O <sub>11</sub> P <sub>2</sub>	Thymidine-3',5'-tetraabenzoyldiphosphate	364
C <sub>38</sub> H <sub>43</sub> N <sub>5</sub> O <sub>9</sub>	5'-O-DMT-N2-isobutyryl-2'-O-(2-methoxyethyl)guanosine	259
C <sub>38</sub> H <sub>47</sub> N <sub>5</sub> O <sub>6</sub> Si	2'-tert-Butyldimethylsilyl-5'-DMT-N6-methyladenosine	131
C <sub>38</sub> H <sub>47</sub> N <sub>3</sub> O <sub>6</sub> Si	N4-Acetyl-3'-O-tert-butylidimethylsilyl-5'-O-DMT-cytidine	12
	N4-Acetyl-2'-O-tert-butylidimethylsilyl-5'-O-DMT-cytidine	12
C <sub>39</sub> H <sub>31</sub> N <sub>3</sub> O <sub>5</sub>	2',3'-Dideoxy-5'-O-DMT-cytidine	241
C <sub>39</sub> H <sub>33</sub> N <sub>5</sub> O <sub>7</sub>	2',3',5'-Tri-O-benzoyl-N6-benzyl-2'-C-methyladenosine	373
C <sub>39</sub> H <sub>35</sub> F <sub>3</sub> N <sub>4</sub> O <sub>8</sub>	N4-Benzoyl-2'-deoxy-5'-O-DMT-2'-trifluoroacetamidocytidine	104
C <sub>39</sub> H <sub>37</sub> N <sub>5</sub> O <sub>7</sub>	2'-Deoxy-5'-O-DMT-N6-phenoxyacetyladenosine	188
	2'-Deoxy-3'-O-DMT-5'-O-phenoxyacetyladenosine	188
	N6-Benzoyl-5'-O-DMT-2'-O-methyladenosine	108
C <sub>39</sub> H <sub>37</sub> N <sub>5</sub> O <sub>8</sub>	5'-O-DMT-N2-phenylacetylguanosine	262
	5'-O-DMT-2'-O-methyl-N6-phenoxyacetyladenosine	261
C <sub>39</sub> H <sub>39</sub> N <sub>5</sub> O <sub>7</sub>	N6-Benzoyl-5'-O-DMT-N3-methyladenosine	108
C <sub>39</sub> H <sub>39</sub> N <sub>3</sub> O <sub>8</sub>	N4-Benzoyl-5'-O-DMT-2'-O-methyl-5-methylcytidine	109
C <sub>39</sub> H <sub>41</sub> N <sub>5</sub> O <sub>10</sub>	2'-Deoxy-5'-O-DMT-N2-isobutyrylguanosine 3'-O-succinate	186
C <sub>39</sub> H <sub>41</sub> N <sub>4</sub> O <sub>22</sub> P <sub>3</sub>	Fluorescein-5(6)-carboxamidocaproyl-(5-[3-aminoallyl]uridine 5'-triphosphate) - 1 mM aqueous solution	275
C <sub>39</sub> H <sub>46</sub> N <sub>4</sub> O <sub>8</sub>	5-[N-(6-Aminoethyl)-3-E-acrylamido]-2'-deoxy-5'-O-DMT-uridine	54
C <sub>39</sub> H <sub>66</sub> N <sub>7</sub> O <sub>17</sub> P <sub>3</sub> S	Linoleoyl coenzyme A	303
C <sub>39</sub> H <sub>67</sub> N <sub>7</sub> O <sub>17</sub> P <sub>3</sub> SK	Oleoyl coenzyme A potassium salt	337
C <sub>39</sub> H <sub>68</sub> N <sub>7</sub> O <sub>17</sub> P <sub>3</sub> S	Oleoyl coenzyme A	337
C <sub>39</sub> H <sub>70</sub> N <sub>7</sub> O <sub>17</sub> P <sub>3</sub> S	Stearoyl coenzyme A	354
C <sub>35</sub> H <sub>35</sub> N <sub>2</sub> O <sub>11</sub> ·C <sub>5</sub> H <sub>9</sub> N	5'-O-DMT-thymidine 3'-O-succinic acid Pyridinium salt	263
C <sub>40</sub> H <sub>41</sub> N <sub>3</sub> O <sub>9</sub>	N4-Benzoyl-5'-O-DMT-2'-O-(2-methoxyethyl)cytidine	108

Formula	Product Name	Page
C <sub>34</sub> H <sub>32</sub> FN <sub>2</sub> O <sub>10</sub> ·C <sub>6</sub> H <sub>16</sub> N	2'-Deoxy-5'-O-DMT-2'-fluorouridine 3'-O-succinate triethylammonium salt	183
C <sub>60</sub> H <sub>72</sub> N <sub>7</sub> O <sub>17</sub> P <sub>3</sub> S	Nonadecanoyl coenzyme A	336
C <sub>41</sub> H <sub>39</sub> N <sub>3</sub> O <sub>10</sub>	5'-O-DMT-2'-O-propylphthalimidouridine	262
C <sub>41</sub> H <sub>41</sub> N <sub>5</sub> O <sub>8</sub>	N-Benzoyl-5'-O-(bis(4-methoxyphenyl)phenylmethyl)-2'-O-(2-methoxyethyl)adenosine	111
C <sub>41</sub> H <sub>41</sub> N <sub>6</sub> O <sub>20</sub> P <sub>3</sub>	Fluorescein alkynylamino-ATP - 1.0 mM solution	275
C <sub>41</sub> H <sub>43</sub> N <sub>3</sub> O <sub>8</sub>	N <sub>4</sub> -Benzoyl-5'-O-DMT-2'-O-(2-Methoxyethyl)-5-methylcytidine	108
C <sub>41</sub> H <sub>44</sub> N <sub>2</sub> O <sub>7</sub> SSi	2'-O-(tert-Butyldimethylsilyl)-3'-O-(phenoxythioncarbonyl)-5'-O-trityluridine	133
C <sub>41</sub> H <sub>45</sub> F <sub>3</sub> N <sub>4</sub> O <sub>9</sub>	5'-O-DMT-5-[N-(6-(trifluoroacetamido)hexyl)-3-E-acrylamido]-2'-deoxyuridine	265
C <sub>35</sub> H <sub>34</sub> FN <sub>2</sub> O <sub>10</sub> ·C <sub>6</sub> H <sub>16</sub> N	1-(2'-Deoxy-5'-O-DMT-2'-fluoro-b-D-arabinofuranosyl)thymine 3'-O-succinate triethylammonium salt	182
C <sub>41</sub> H <sub>51</sub> N <sub>5</sub> O <sub>8</sub> Si	5'-O-(4,4'-Dimethoxytrityl)-2'-O-(tertbutyldimethylsilyl)-N-isobutryl-Guanosine 3'-O-tert-Butyldimethylsilyl-5'-O-DMT-N <sub>2</sub> -isobutrylguanosine	250
C <sub>35</sub> H <sub>36</sub> N <sub>2</sub> O <sub>11</sub> ·C <sub>6</sub> H <sub>15</sub> N	5'-O-DMT-thymidine 3'-O-succinate triethylammonium salt	263
C <sub>42</sub> H <sub>41</sub> N <sub>3</sub> O <sub>10</sub>	5'-O-DMT-5-methyl-3'-O-propylphthalimidouridine	261
C <sub>42</sub> H <sub>43</sub> N <sub>5</sub> O <sub>8</sub>	2'-Deoxy-5'-O-DMT-N <sub>2</sub> -(4-isopropylphenoxyacetyl)guanosine	187
C <sub>42</sub> H <sub>43</sub> N <sub>3</sub> O <sub>13</sub> S	3-N-Boc-5'-O-DMT-3'-O-nosylthymidine	122
C <sub>42</sub> H <sub>47</sub> N <sub>12</sub> O <sub>28</sub> S <sub>8</sub>	S-Adenosylmethione-1,4-butanedisulfonate	28
C <sub>43</sub> H <sub>49</sub> N <sub>3</sub> O <sub>8</sub> Si	N <sub>4</sub> -Benzoyl-3'-O-tert-butylidimethylsilyl-5'-O-DMT-cytidine	96
	N <sub>4</sub> -Benzoyl-2'-O-tert-butylidimethylsilyl-5'-O-DMT-cytidine	96
C <sub>37</sub> H <sub>35</sub> N <sub>3</sub> O <sub>9</sub> P·C <sub>6</sub> H <sub>16</sub> N	N <sub>4</sub> -Benzoyl-2'-deoxy-5'-O-DMT-cytidine 3'-phosphonate triethylammonium salt	100
C <sub>43</sub> H <sub>52</sub> FN <sub>6</sub> O <sub>7</sub> P	2'-Deoxy-N <sub>2</sub> -DMF-5'-DMT-2'-fluoroguanosine 3'-CE phosphoramidite	181
C <sub>43</sub> H <sub>82</sub> N <sub>13</sub> O <sub>19</sub> P <sub>3</sub> S <sub>2</sub>	Biotinyl coenzyme A	120
C <sub>44</sub> H <sub>45</sub> N <sub>3</sub> O <sub>10</sub>	5'-O-DMT-3'-O-hexylphthalimidouridine	258
	5'-O-DMT-2'-O-hexylphthalimidouridine	258
C <sub>44</sub> H <sub>46</sub> N <sub>4</sub> O <sub>9</sub>	5'-O-DMT-2'-O-hexylphthalimidocytidine	257
C <sub>44</sub> H <sub>49</sub> N <sub>5</sub> O <sub>7</sub> Si	N <sub>6</sub> -Benzoyl-3'-O-tert-butylidimethylsilyl-5'-O-DMT-adenosine	95
	N <sub>6</sub> -Benzoyl-2'-O-tert-butylidimethylsilyl-5'-O-DMT-adenosine	95
C <sub>44</sub> H <sub>50</sub> N <sub>6</sub> O <sub>6</sub> Si	3'-Amino-N <sub>6</sub> -benzoyl-2'-O-tert-butylidimethylsilyl-5'-O-DMT-3'-deoxyadenosine	37
C <sub>38</sub> H <sub>35</sub> N <sub>5</sub> O <sub>8</sub> P·C <sub>6</sub> H <sub>16</sub> N	N <sub>6</sub> -Benzoyl-2'-deoxy-5'-O-DMT-adenosine 3'-phosphonate triethylammonium salt	98
C <sub>45</sub> H <sub>47</sub> N <sub>3</sub> O <sub>10</sub>	5'-O-DMT-3'-O-hexylphthalimido-5-methyluridine	258
	5'-O-DMT-2'-O-hexylphthalimido-5-methyluridine	257
C <sub>39</sub> H <sub>39</sub> FN <sub>5</sub> O <sub>10</sub> ·C <sub>6</sub> H <sub>16</sub> N	9-(2'-Deoxy-5'-O-DMT-2'-fluoro-b-D-arabinofuranosyl)-N <sub>2</sub> -isobutrylguanine 3'-O-succinate triethylammonium salt	182
C <sub>39</sub> H <sub>40</sub> FN <sub>5</sub> O <sub>10</sub> ·C <sub>6</sub> H <sub>16</sub> N	2'-Deoxy-5'-O-DMT-2'-fluoro-N <sub>2</sub> -isobutrylguanosine 3'-O-succinate triethylammonium salt	183
C <sub>46</sub> H <sub>45</sub> N <sub>3</sub> O <sub>13</sub> S	3-N-(2,4-Dimethylbenzyl)-1-(5'-O-DMT-3'-O-nitrophenylsulphonyl-2'-deoxy-b-D-lyxofuranosyl)thymidine	251
C <sub>46</sub> H <sub>49</sub> N <sub>5</sub> O <sub>6</sub> S	2'-Deoxy-5'-O-DMT-N <sub>2</sub> -isobutryl-3'-xanthylguanosine	187
C <sub>46</sub> H <sub>53</sub> N <sub>6</sub> O <sub>9</sub> P	5-Aza-N <sub>6</sub> -benzoyl-5'-O-DMT-2'-deoxycytidine 2'-CE phosphoramidite	76
C <sub>40</sub> H <sub>45</sub> N <sub>2</sub> O <sub>11</sub> ·C <sub>6</sub> H <sub>16</sub> N	5'-O-DMT-5-methyl-2'-O-pentyluridine 3'-O-succinate triethylammonium salt	260
C <sub>46</sub> H <sub>63</sub> N <sub>4</sub> O <sub>9</sub> PSi	2'-O-tert-Butyldimethylsilyl-5'-O-DMT-3-methyluridine 3'-CE phosphoramidite	132
C <sub>47</sub> H <sub>36</sub> N <sub>2</sub> O <sub>6</sub> S <sub>2</sub>	2',3'-Di(9-phenylxanthen-9-yl)dithiouridine	253
C <sub>47</sub> H <sub>47</sub> N <sub>5</sub> O <sub>9</sub>	O <sub>6</sub> -Diphenylcarbonyl-N <sub>2</sub> -isobutryl-1-(5'-O-DMT-b-D-arabinofuranosyl) guanine	252
C <sub>41</sub> H <sub>39</sub> N <sub>3</sub> O <sub>10</sub> ·C <sub>6</sub> H <sub>15</sub> N	N <sub>4</sub> -Benzoyl-2'-deoxy-5'-O-DMT-cytidine 3'-O-succinate triethylamine salt	100

Formula	Product Name	Page
C <sub>47</sub> H <sub>58</sub> N <sub>5</sub> O <sub>12</sub> P	N-Acetyl-5-[1,2-bis(acetyloxy)ethyl]-5'-O-DMT-2'-deoxycytidine	11
C <sub>47</sub> H <sub>64</sub> N <sub>7</sub> O <sub>7</sub> Si	2'-O-tert-Butyldimethylsilyl-5'-O-DMT-C <sub>2</sub> -methyladenosine 3'-CE phosphoramidite	131
C <sub>47</sub> H <sub>64</sub> N <sub>7</sub> O <sub>8</sub> PSi	2'-O-tert-Butyldimethylsilyl-5'-O-DMT-1-methylguanosine 3'-CE phosphoramidite	131
C <sub>48</sub> H <sub>48</sub> ClN <sub>8</sub> O <sub>6</sub> P	[(2S,6R)-6-(N <sub>2</sub> -(Isobutryl)-O <sub>6</sub> -(diphenylcarbonyl)guanin-9-yl)-4-tritylmorpholin-2-yl]methyl dimethylphosphoramidochloridate	296
C <sub>48</sub> H <sub>53</sub> N <sub>6</sub> O <sub>8</sub> PS <sub>2</sub>	2'-Deoxy-3'-O-DMT-N <sub>2</sub> -isobutrylguanosine 5'-thiophosphoramidite	186
C <sub>42</sub> H <sub>39</sub> N <sub>5</sub> O <sub>9</sub> ·C <sub>6</sub> H <sub>15</sub> N	N <sub>6</sub> -Benzoyl-2'-deoxy-5'-O-DMT-adenosine 3'-O-succinate triethylammonium salt	98
C <sub>42</sub> H <sub>38</sub> FN <sub>5</sub> O <sub>9</sub> ·C <sub>6</sub> H <sub>16</sub> N	N <sub>6</sub> -Benzoyl-9-(2'-deoxy-5'-O-DMT-2'-fluoro-b-D-arabinofuranosyl)adenine 3'-O-succinate triethylammonium salt	102
C <sub>42</sub> H <sub>40</sub> FN <sub>3</sub> O <sub>10</sub> ·C <sub>6</sub> H <sub>16</sub> N	N <sub>4</sub> -Benzoyl-1-(2'-deoxy-5'-O-DMT-2'-fluoro-b-D-arabinofuranosyl)-5-methylcytosine-3'-O-succinate triethylammonium salt	102
C <sub>49</sub> H <sub>56</sub> N <sub>7</sub> O <sub>9</sub> P	5'-O-DMT-N <sub>6</sub> -methyl-N <sub>6</sub> -phenoxyacetyladenosine 3'-CE phosphoramidite	261
C <sub>50</sub> H <sub>51</sub> N <sub>4</sub> O <sub>8</sub> PS <sub>2</sub>	N <sub>4</sub> -Benzoyl-2'-deoxy-5'-O-DMT-cytidine 5'-thiophosphoramidite	101
C <sub>51</sub> H <sub>51</sub> N <sub>6</sub> O <sub>9</sub> PS <sub>2</sub>	N <sub>6</sub> -Benzoyl-2'-deoxy-5'-O-DMT-adenosine 3'-thiophosphoramidite	99
C <sub>513</sub> C <sub>5</sub> H <sub>15</sub> N <sub>5</sub> O <sub>10</sub> P <sub>2</sub>	Adenosine 5'-Diphosphate-13C <sub>5</sub>	24





**CAS Index**

## CAS Index

CAS	Product Code	Page	CAS	Product Code	Page	CAS	Product Code	Page
[50-89-5]	NT02592	365	[767-16-8]	NA44281	56	[2226-72-4]	NA09600	76
[50-90-8]	NC04688	145	[784-71-4]	ND06544	204	[2226-74-6]	NA09599	76
[50-91-9]	ND02921	204	[789-61-7]	ND08563	221	[2239-64-7]	NM02964	305
[53-59-8]	NN45264	331	[838-07-3]	ND06242	214	[2273-93-0]	ND29030	236
[53-83-8]	NT10843	360	[890-38-0]	ND05750	208	[2293-64-7]	NM02964	305
[53-84-9]	NN11969	333	[892-48-8]	NC05644	142	[2305-87-5]	NA57402	60
[53-85-0]	ND06701	235	[892-49-9]	NM06321	358	[2341-22-2]	NF04135	276
[54-25-1]	NA02765	79	[902-04-5]	ND29406	206	[2346-74-9]	NC11301	149
[54-42-2]	ND05147	210	[932-53-6]	NA30768	78	[2353-33-5]	NA02969	78
[58-58-2]	NP09203	346	[951-77-9]	ND06286	177	[2382-65-2]	NC59514	162
[58-61-7]	NA31619	27	[951-78-0]	ND06282	225	[2382-66-3]	NA07946	29
[58-61-7]	NA106350	27	[957-75-5]	NB03843	129	[2387-48-6]	ND69830	231
[58-61-7]	NA01639	27	[957-77-7]	NH32540	291	[2392-46-0]	NA05778	29
[58-63-9]	NI06297	293	[958-09-8]	ND04011	173	[2434-53-9]	NA03107	59
[58-64-0]	NA10698	24	[958-09-8]	ND08541	172	[2450-08-0]	NP57387	347
[58-64-0]	NA63511	24	[958-74-7]	NM06239	326	[2457-80-9]	ND07992	216
[58-96-8]	NU06309	382	[961-07-9]	ND06306	205	[2498-41-1]	ND10012	214
[58-97-9]	NU05691	381	[964-21-6]	ND157121	215	[2502-99-0]	NC65881	151
[59-14-3]	NB06315	126	[964-26-1]	ND153405	224	[2504-55-4]	NA03336	45
[60-92-4]	NA08991	22	[979-92-0]	NA17223	28	[2564-35-4]	ND06585	206
[61-19-8]	NA06318	25	[1022-79-3]	NB06450	124	[2564-35-4]	ND46292	206
[63-37-6]	NC02951	160	[1024-99-3]	NI02225	295	[2564-35-4]	ND46296	266
[63-39-8]	NU04388	381	[1032-65-1]	ND02993	175	[2564-35-4]	ND46295	266
[65-46-3]	NC04070	162	[1053-73-2]	NA44795	21	[2564-35-4]	ND46294	265
[65-47-4]	NC03860	161	[1094-61-7]	NH45555	334	[2620-62-4]	ND04708	251
[69-33-0]	ND06290	164	[1147-23-5]	NI04748	294	[2627-69-2]	NA03552	56
[69-74-9]	NA05780	73	[1175-34-4]	NP09389	345	[2646-71-1]	NN10871	332
[70-00-8]	NT04884	376	[1184-16-3]	NN11662	332	[2858-20-0]	NA67922	41
[73-03-0]	ND02930	173	[1264-52-4]	NO47202	337	[2863-04-9]	NT09781	363
[84-21-9]	NA66252	25	[1264-57-9]	ND47196	170	[2880-89-9]	NC02866	153
[84-52-6]	NC03937	161	[1341-23-7]	NN15702	334	[2922-74-9]	ND15298	171
[85-31-4]	NT04480	360	[1425-63-4]	ND71063	231	[2923-73-1]	ND03465	200
[85-32-5]	NG09355	284	[1445-07-4]	NP11297	345	[2946-36-3]	NA06751	57
[85-61-0]	NC45965	154	[1463-10-1]	NM04922	328	[2946-39-6]	NB03414	123
[85-94-9]	NC03937	161	[1492-62-2]	NF77069	275	[3001-47-6]	NA46036	39
[85-94-9]	NC13474	161	[1513-69-5]	NA44301	56	[3031-94-5]	NA07204	56
[86-01-1]	NG03984	285	[1582-79-2]	ND22463	236	[3031-95-6]	NS45131	354
[86-08-8]	NA30683	20	[1681-15-8]	NC15936	152	[3036-18-8]	NC28916	160
[118-00-3]	NG06314	286	[1716-06-9]	NO63224	337	[3056-17-5]	ND07118	239
[131-99-7]	NI10026	292	[1716-06-9]	NO47203	337	[3056-18-6]	ND04495	238
[146-14-5]	NR35410	350	[1748-04-5]	NT08060	374	[3066-86-2]	NB06281	124
[146-76-9]	NB08372	123	[1763-10-6]	NP46059	338	[3080-29-3]	NA06227	27
[146-77-0]	NC06293	140	[1780-36-5]	NT67801	375	[3083-77-0]	NA05962	75
[146-78-1]	NF08852	276	[1818-71-9]	NR09651	351	[3094-09-5]	ND02968	204
[146-80-5]	NX02884	384	[1867-73-8]	NM32281	311	[3130-39-0]	NM71656	309
[147-94-4]	NA05771	73	[1927-31-7]	ND05744	172	[3130-39-0]	NM71655	309
[155-10-2]	NA44305	41	[1927-31-7]	ND46290	163	[3130-72-1]	NM47200	330
[155-12-4]	NC11515	146	[1927-31-7]	ND46296	266	[3131-60-0]	NA02728	76
[155-90-8]	NA44306	57	[1927-31-7]	ND46295	266	[3181-38-2]	NT06708	371
[271-70-5]	NP32608	348	[1927-31-7]	ND46294	265	[3237-37-4]	NG31507	283
[314-50-1]	NO08048	338	[1956-30-5]	ND08349	228	[3240-72-0]	ND66272	232
[316-46-1]	NF04076	280	[1969-54-6]	NT07991	366	[3257-73-6]	NT05401	374
[320-67-2]	NA02947	76	[2002-35-9]	ND06386	213	[3258-07-9]	NR31832	352
[342-69-8]	NM06304	320	[2004-06-0]	NC06562	153	[3289-47-2]	NA57396	58
[362-42-5]	NI08545	299	[2004-07-1]	NA04201	43	[3289-50-7]	NA11521	52
[362-43-6]	NI05371	300	[2018-19-1]	NA08373	78	[3352-23-6]	NA46044	29
[362-66-3]	NS47205	354	[2096-10-8]	NA02915	33	[3387-36-8]	NU02983	380
[362-74-3]	NR145431	350	[2104-68-9]	NC06679	146	[3416-05-5]	ND06301	222
[362-75-4]	NI05151	299	[2140-11-6]	NI03500	299	[3424-98-4]	NT02679	365
[362-76-5]	NI06120	299	[2140-25-2]	NA09588	11	[3458-14-8]	ND08408	222
[365-07-1]	NT32262	364	[2140-61-6]	NM03720	315	[3524-87-6]	NH66985	290
[365-08-2]	NT10135	365	[2140-64-9]	NM05757	315	[3545-76-4]	NI10382	292
[489-59-8]	NI24672	298	[2140-65-0]	NM08574	319	[3590-36-1]	NM29555	313
[550-33-4]	NR05251	351	[2140-67-2]	ND05647	252	[3608-58-0]	ND06319	207
[574-25-4]	NT08808	360	[2140-69-4]	NM06185	328	[3616-24-8]	NA02525	48
[605-23-2]	NA08059	74	[2140-71-8]	NM02941	318	[3624-46-2]	ND46293	364
[606-58-6]	NT44985	369	[2140-72-9]	NM06302	315	[3624-46-2]	NT10135	365
[606-68-8]	NN12622	333	[2140-76-3]	NM04259	327	[3624-46-2]	ND46296	266
[611-53-0]	ND05777	209	[2140-77-4]	NM35522	319	[3624-46-2]	ND46295	266
[634-01-5]	NA10355	21	[2140-79-6]	NM05694	310	[3624-46-2]	ND46294	265
[653-63-4]	ND05971	171	[2147-59-3]	NT29845	363	[3676-72-0]	NB06331	109
[672-45-7]	ND57450	376	[2149-82-8]	NO71879	338	[3690-10-6]	ND09503	225
[737-76-8]	NA46264	84	[2169-64-4]	NT32421	369	[3731-55-3]	ND31484	210

CAS	Product Code	Page	CAS	Product Code	Page	CAS	Product Code	Page
[3736-77-4]	NA05939	69	[6038-59-1]	NM06248	327	[13912-93-1]	NG46689	284
[3768-18-1]	NA05753	13	[6046-63-5]	ND09546	227	[13957-31-8]	NT06186	362
[3828-96-4]	NF32079	280	[6057-44-9]	NS45131	354	[14062-45-4]	NA71841	61
[3868-31-3]	NC005772	338	[6161-23-5]	ND04658	227	[14160-93-1]	NA57367	42
[3868-32-4]	NA04479	54	[6220-63-9]	ND46720	175	[14161-09-2]	NM44273	305
[3868-33-5]	NA05711	33	[6244-92-4]	NL47197	302	[14259-58-6]	ND144937	210
[3881-21-8]	NM05162	319	[6253-56-1]	NX143915	384	[14260-82-3]	ND07899	209
[3992-42-5]	ND02591	174	[6313-54-8]	NCT07186	152	[14270-73-6]	NT08746	223
[4016-63-1]	NB06311	127	[6313-54-8]	NC70185	148	[14365-44-7]	NA03337	44
[4090-29-3]	NT71492	360	[6336-50-1]	NB67066	118	[14365-45-8]	ND04246	173
[4097-04-5]	ND46856	229	[6554-10-5]	NT06665	378	[14504-60-0]	NM06451	326
[4097-22-7]	ND06741	240	[6612-73-3]	NA08525	13	[14599-46-3]	NC58344	137
[4099-81-4]	ND04751	208	[6698-26-6]	ND07997	240	[14985-44-5]	NB05283	124
[4099-84-7]	NA16031	47	[6698-29-9]	NT139052	368	[14999-52-1]	ND13488	208
[4105-38-8]	NT06907	372	[6706-56-5]	NF146409	280	[15176-29-1]	ND08006	190
[4105-39-9]	NM09610	324	[6709-57-5]	NL47198	303	[15386-69-3]	ND29524	192
[4208-67-7]	ND11202	223	[6736-58-9]	ND04697	164	[15397-12-3]	NM07917	310
[4291-63-8]	NC06337	141	[6757-06-8]	NC05637	160	[15400-54-1]	NE57380	271
[4294-16-0]	NB06325	114	[6918-37-2]	NG07985	287	[15400-58-5]	NM44304	316
[4294-17-1]	NB04599	115	[6979-94-8]	NT06136	371	[15465-92-6]	NC16520	149
[4338-47-0]	NK06717	301	[7013-16-3]	NA03401	74	[15717-45-0]	NT05775	369
[4372-67-2]	NA06674	80	[7057-27-4]	ND05963	225	[15718-49-7]	NG145480	283
[4449-43-8]	NT00283	365	[7057-33-2]	ND06564	177	[15718-50-0]	NU16888	380
[4489-34-3]	ND44280	237	[7057-48-9]	ND05186	241	[15718-51-1]	NC11429	159
[4494-26-2]	ND29039	205	[7075-11-8]	NA10080	73	[15763-06-1]	NM03697	311
[4542-23-8]	NS16562	354	[7084-29-9]	ND02776	217	[15763-11-8]	NH06266	288
[4546-54-7]	NA04488	62	[7226-77-9]	NH15898	290	[15811-32-2]	NT09632	371
[4546-55-8]	NB06291	93	[7236-57-9]	NT06341	361	[15888-38-7]	NA04029	19
[4546-70-7]	NA06287	45	[7253-19-2]	NT10016	368	[15958-99-3]	ND08410	226
[4546-72-9]	NB06336	97	[7387-57-7]	NT04548	369	[16006-64-7]	NM46495	323
[4552-61-8]	NB16621	117	[7403-25-0]	NA05223	50	[16178-48-6]	NA10195	23
[4578-31-8]	NA03463	24	[7415-69-2]	NG09782	283	[16220-07-8]	NA07960	31
[4594-45-0]	NC06422	144	[7415-69-2]	NG08963	283	[16268-29-4]	NT29845	363
[4691-65-0]	NI02985	292	[7481-89-2]	ND06559	240	[16321-99-6]	NT04678	370
[4710-68-3]	NA07179	26	[7504-94-1]	NP57400	347	[16373-93-6]	ND04011	173
[4753-02-0]	NB02946	125	[7665-99-8]	NG03522	283	[16526-56-0]	NM46832	310
[4753-04-2]	NC04257	145	[7724-76-7]	ND08001	251	[16541-19-8]	NT36522	359
[4754-39-6]	ND002599	173	[7791-71-1]	NT08062	378	[16595-02-1]	ND46159	208
[4803-88-7]	NA45440	89	[7803-88-5]	NM02922	319	[16710-13-7]	NM08576	328
[4836-13-9]	NB02991	98	[9001-32-5]	NF32352	274	[16752-71-9]	NT29846	363
[4914-73-2]	NM46468	325	[9002-04-4]	NT32354	362	[16754-79-3]	NC06328	141
[4958-39-8]	NA10682	25	[9007-49-2]	ND10028	221	[16754-80-6]	NC05369	141
[4988-64-1]	NT08808	360	[9027-60-5]	NA16429	19	[16848-12-7]	NA31829	48
[5018-38-2]	ND11522	236	[10074-18-7]	NG59700	282	[16975-94-3]	NC29205	136
[5116-22-3]	NM34075	307	[10202-53-8]	NA46044	29	[16980-89-5]	ND07996	235
[5116-24-5]	ND08018	208	[10212-13-2]	ND08887	228	[17176-17-9]	NA04017	28
[5135-30-8]	NT07155	368	[10212-19-8]	NC03763	142	[17199-43-8]	ND78221	202
[5168-36-5]	ND08235	208	[10212-20-1]	ND06189	196	[17318-21-7]	NA141793	77
[5241-10-1]	ND08562	213	[10212-25-6]	NA01967	67	[17331-13-4]	ND10841	181
[5399-87-1]	NC06562	153	[10299-44-2]	NA02698	75	[17331-20-3]	ND146470	180
[5424-19-1]	NB70237	112	[10300-22-5]	NM03526	310	[17331-22-5]	ND57357	249
[5442-24-0]	NA70257	52	[10300-27-3]	NM06232	318	[17331-53-2]	NB08509	113
[5451-33-2]	NA70525	55	[10302-78-0]	NT57363	369	[17388-80-6]	NS16860	354
[5472-41-3]	NA65977	56	[10302-79-1]	ND04704	180	[17676-65-2]	NC07979	140
[5536-17-4]	NA06007	72	[10356-76-0]	ND10199	196	[17720-18-2]	NN16815	335
[5550-12-9]	NG02982	284	[10414-81-0]	NA02636	45	[18354-06-8]	NA16509	75
[5624-35-1]	NN46649	334	[10578-79-7]	NM76577	316	[18368-73-5]	NM67852	321
[5626-99-3]	ND07999	247	[13030-62-1]	ND02986	228	[18417-89-5]	NS139064	353
[5627-00-9]	ND144870	248	[13085-50-2]	ND13487	174	[18422-05-4]	NA30567	24
[5734-64-5]	NA11514	41	[13089-48-0]	NB01918	96	[18423-40-0]	ND06585	206
[5843-59-4]	NC29021	152	[13106-85-9]	NT44266	376	[18423-43-3]	NT05748	365
[5856-48-4]	NI08025	300	[13153-27-0]	NN09411	335	[18439-24-2]	NC20534	155
[5959-90-0]	NA46695	29	[13239-96-8]	ND10281	253	[18549-65-0]	ND11318	170
[5964-41-0]	ND04743	171	[13239-97-9]	NT02911	359	[19186-33-5]	NC29204	135
[5968-90-1]	NX28984	383	[13276-43-2]	NC03338	147	[19234-66-3]	NC07451	138
[5974-93-6]	ND16317	239	[13276-52-3]	ND05330	238	[19235-17-7]	NH35521	289
[5983-09-5]	ND06551	246	[13364-95-9]	NM63327	311	[19316-85-9]	NA06452	88
[5987-73-5]	NT10156	372	[13389-03-2]	NB05782	124	[19316-88-2]	ND144597	216
[5987-76-8]	NC16519	148	[13474-03-6]	NA03463	24	[19396-06-6]	NP140526	342
[6010-91-9]	NA71089	31	[13474-03-8]	NA10369	25	[19416-70-7]	NA30959	64
[6018-48-0]	NC57355	160	[13484-66-7]	NB30216	114	[19817-92-6]	NU03863	381
[6025-53-2]	NZ30302	385	[13484-67-8]	NK30244	301	[19916-77-9]	ND06236	215
[6027-83-4]	NG57356	286	[13860-38-3]	NM35520	322	[19916-78-0]	ND09163	206

## CAS Index

CAS	Product Code	Page	CAS	Product Code	Page	CAS	Product Code	Page
[20111-18-6]	NN44827	333	[26287-69-4]	NU04051	382	[35959-50-3]	ND08409	246
[20187-82-0]	ND144479	191	[26305-13-5]	ND44311	248	[36051-31-7]	NG30609	285
[20227-41-2]	ND09204	192	[26315-55-9]	ND30902	239	[36051-67-9]	NI09674	293
[20235-78-3]	NT02881	361	[26383-05-1]	ND157123	213	[36051-68-0]	NC03860	161
[20244-86-4]	NM08037	319	[26524-60-7]	NC02628	162	[36340-61-1]	NA66773	41
[20268-93-3]	NI30240	298	[26578-09-6]	NG05944	286	[36791-04-5]	NR02712	350
[20310-60-5]	NA44287	23	[26879-47-0]	NM06240	327	[36847-11-7]	NT57417	374
[20398-34-9]	NA08996	23	[26889-39-4]	NA05270	49	[36963-58-3]	NA00714	68
[20594-00-7]	NM06229	315	[26889-42-9]	NA02637	45	[37063-35-7]	NA07178	21
[20724-73-6]	NM07918	315	[26929-65-7]	NA06303	88	[37113-42-1]	ND71741	216
[20737-41-1]	NA57368	61	[26974-09-4]	NA57415	60	[37390-66-2]	ND08402	236
[20813-76-7]	NI02985	292	[27089-56-1]	NA08057	78	[37676-40-7]	NC71639	139
[20859-00-1]	NM30233	325	[27214-06-8]	NC03937	161	[37731-67-2]	ND144802	201
[20978-32-9]	NA02978	27	[27552-97-2]	NC07990	163	[37739-05-2]	NC07978	140
[21028-20-6]	NM02913	313	[27821-45-0]	NU03399	380	[37839-81-9]	NA08992	21
[21038-67-5]	NP44307	346	[27821-54-1]	ND02976	266	[38048-32-7]	NM09410	335
[21052-18-6]	NT16569	374	[27826-76-2]	NM46062	312	[38313-48-3]	NA02980	69
[21052-20-0]	ND59548	225	[27955-44-8]	NM57414	322	[38806-38-1]	NN26196	334
[21090-30-2]	NA08376	20	[27999-47-9]	ND06470	223	[38817-29-7]	ND02968	204
[21138-24-9]	NI06221	293	[27999-55-9]	NT16566	368	[38819-10-2]	NA06002	74
[21323-71-7]	NC44308	150	[28225-17-4]	NA07968	71	[38966-30-2]	NG40772	284
[21466-01-3]	NC10383	139	[28516-86-1]	NM71637	309	[39007-51-7]	NE01669	269
[21573-15-9]	NA44328	43	[28542-78-1]	NZ08027	385	[39030-43-8]	NI09827	300
[21679-12-9]	ND29528	192	[28585-51-5]	NT02914	361	[39491-53-7]	NE07208	271
[21679-14-1]	NF05140	274	[28616-93-5]	NB02934	126	[39513-54-7]	NP57376	347
[21870-09-7]	NB71641	127	[29049-22-7]	ND12015	226	[39824-26-5]	NC04682	148
[21931-53-3]	NU03399	380	[29241-66-5]	NB67359	126	[39944-62-2]	NT44267	355
[22003-12-9]	ND71642	214	[29416-86-2]	NA68095	60	[39967-60-7]	ND06413	219
[22140-20-1]	NM10203	324	[29428-50-0]	NM45525	306	[40027-70-1]	NT08918	376
[22423-26-3]	NA06711	68	[29706-84-1]	NA10412	88	[40093-94-5]	ND05747	177
[22536-66-9]	NC57418	152	[29706-85-2]	NA06326	87	[40144-12-5]	NM08056	335
[22663-55-4]	ND30220	248	[29706-85-2]	NA32046	87	[40423-35-6]	NM29027	324
[22837-44-1]	ND05774	207	[29851-57-8]	NH08494	288	[40436-88-2]	NA57558	23
[22882-02-6]	ND153424	214	[29886-19-9]	ND66842	226	[40615-39-2]	ND03361	264
[22961-45-1]	NP66702	340	[29908-03-0]	NA16291	29	[40627-30-3]	ND00041	167
[22976-86-9]	NP157259	342	[29984-33-6]	NA09216	72	[40656-71-1]	NC09808	141
[23001-60-7]	NA46037	62	[30516-87-1]	NA05636	88	[40732-48-7]	NG08975	283
[23111-00-4]	NN45059	334	[31008-64-7]	NA06911	24	[40733-28-6]	NB08945	133
[23192-63-4]	NA11708	63	[31281-88-6]	NI36298	293	[40769-69-5]	ND44297	231
[23197-96-8]	NP58309	345	[31284-94-3]	ND30226	248	[40789-35-3]	ND06772	180
[23197-98-0]	NB143914	127	[31356-86-2]	ND138532	209	[40811-89-0]	NB45915	114
[23205-42-7]	ND16524	170	[31448-54-1]	NM07919	327	[40922-97-2]	NB45917	114
[23205-67-6]	NF10198	276	[31501-19-6]	ND06307	225	[40922-97-2]	NB04595	114
[23220-74-8]	NT58307	373	[31501-46-9]	NA05630	69	[40925-28-8]	NR46024	349
[23274-21-7]	NA11364	63	[31698-14-3]	NA02790	67	[41094-07-9]	NH08019	290
[23583-48-4]	NB07972	122	[31766-13-9]	NA17929	68	[41107-56-6]	ND04228	243
[23643-36-9]	NT07136	374	[31966-52-6]	NA09241	79	[41244-53-5]	NB57419	126
[23660-98-2]	NM30298	308	[32140-51-5]	NA45964	12	[41432-67-1]	NC01366	157
[23666-24-2]	NT30291	368	[32387-56-7]	NC08279	142	[41547-83-5]	NG07983	287
[23669-79-6]	ND05965	189	[32452-17-8]	NC31507	283	[41552-82-3]	NC45738	158
[24121-01-5]	NM71636	317	[32738-09-3]	NM08039	326	[41941-56-4]	NC10380	139
[24292-60-2]	NN44916	38	[32909-05-0]	NA08263	13	[41941-56-4]	NC10381	139
[24346-00-7]	NA29499	231	[33008-99-0]	NP46568	341	[42155-08-8]	ND02992	224
[24386-93-4]	ND09248	169	[33430-61-4]	ND02996	205	[42204-44-4]	NA16030	86
[24415-66-5]	NC44309	150	[33430-62-5]	NT02975	364	[42563-71-3]	NU05635	379
[24514-32-7]	ND05865	216	[33818-15-4]	NC05679	153	[42867-68-5]	ND29820	241
[24639-06-3]	NC06329	148	[34079-68-0]	ND03400	230	[43139-22-6]	NG08963	283
[24719-82-2]	NC06332	135	[34218-84-3]	NI06234	295	[43157-50-2]	NT07655	358
[24751-69-7]	NF76155	275	[34245-48-2]	NA46265	86	[43170-89-4]	NM72044	324
[24757-70-8]	ND15747	213	[34308-25-3]	NM08030	308	[45459-15-8]	NC65881	151
[25045-61-8]	NN47201	336	[34369-07-8]	NA00135	26	[48212-99-3]	NA07969	71
[25130-29-4]	NC03341	140	[34393-59-4]	NC46163	160	[50270-97-8]	ND145456	203
[25137-84-2]	NE06039	271	[34408-14-5]	NC03343	140	[50408-20-3]	ND66663	234
[25152-20-9]	NA06395	49	[35094-46-3]	NA58205	26	[50443-29-3]	NA56265	332
[25193-95-7]	NH57421	290	[35109-88-7]	NI04749	293	[50593-92-5]	NB44268	128
[25442-42-6]	NT09993	378	[35170-03-7]	NU07383	380	[50868-58-1]	NT30288	367
[25526-93-6]	ND02399	202	[35542-01-9]	NM08028	308	[50908-62-8]	NC07982	158
[25615-16-1]	NZ30328	385	[35808-68-5]	NC44312	149	[50924-49-7]	NM09731	329
[25746-87-6]	ND57369	249	[35874-49-8]	NA12011	33	[51034-68-5]	NA05412	84
[25899-70-1]	NX09700	384	[35908-14-6]	NA16501	30	[51116-01-9]	NB07973	126
[25953-14-4]	ND06454	210	[35908-31-7]	NI09673	293	[51239-26-0]	NC10430	151
[26001-38-7]	NT07601	360	[35920-39-9]	NE06155	270	[51246-79-8]	ND01970	242
[26227-04-3]	NA16207	92	[35943-35-2]	NT08796	375	[51247-09-7]	NA02562	17

CAS	Product Code	Page	CAS	Product Code	Page	CAS	Product Code	Page
[51432-32-7]	NB09916	125	[61787-10-8]	NC02619	144	[70580-89-1]	NA12252	46
[51464-82-5]	NM71743	325	[61845-39-4]	NT08058	366	[70580-90-4]	NA12253	49
[51549-36-1]	NB08718	95	[61966-08-3]	NT44794	375	[70838-44-7]	NB03505	94
[51549-39-4]	NB63417	95	[62160-23-0]	ND05752	168	[71184-20-8]	NC15795	136
[51549-49-6]	ND07995	233	[62230-89-1]	NP46146	341	[71214-29-4]	NU58208	381
[51549-54-3]	ND07994	232	[62471-63-0]	ND02928	217	[71774-13-5]	NA08994	22
[51998-91-5]	NB29023	117	[62512-97-4]	NZ30326	384	[71783-24-9]	NG09615	285
[52023-48-0]	NH67971	289	[63142-70-1]	NR10471	348	[71914-80-2]	NA04017	28
[52176-13-3]	NB44313	128	[63142-71-2]	NR09650	349	[72003-83-9]	ND13490	171
[52278-77-0]	ND02927	207	[63142-71-2]	NR63594	349	[72209-20-2]	NC06333	137
[52450-18-7]	NA02831	49	[63225-09-2]	ND46694	175	[72218-68-9]	NB02946	125
[52571-45-6]	NB06418	112	[63264-29-9]	NI08522	297	[72560-69-1]	NA07943	13
[52602-68-3]	NC44314	149	[63425-04-7]	NA17231	30	[72696-48-1]	NA10696	23
[53296-10-9]	NP07291	340	[63541-62-8]	ND145453	195	[73051-69-1]	ND10433	190
[53595-18-9]	NA63573	24	[63639-21-4]	NT07958	370	[73196-87-9]	NT07343	371
[53696-59-6]	NA04422	79	[63660-23-1]	NB08023	105	[73196-87-9]	NT16567	371
[54394-90-0]	NC09380	160	[64145-29-5]	ND32069	176	[73208-40-9]	NA58197	22
[54447-84-6]	NC64061	156	[64183-27-3]	ND02827	192	[73449-07-7]	ND09532	191
[54660-78-5]	NC57423	140	[64325-78-6]	NB02601	100	[73647-09-3]	NG16741	283
[54684-83-2]	NP44590	342	[64350-24-9]	NI03488	296	[73971-82-1]	NA05636	88
[54735-61-4]	NI10699	292	[64623-37-6]	NC15472	159	[74131-06-9]	NC08239	138
[54874-07-6]	NC46261	161	[64911-18-8]	NB18821	121	[74249-68-6]	NG74932	360
[54925-33-6]	NC09356	159	[65358-15-8]	NP16241	345	[74299-50-6]	ND04010	172
[54925-71-2]	NB46819	133	[65358-18-1]	ND63440	219	[74405-40-6]	ND10585	263
[55196-46-8]	ND157877	247	[65367-85-3]	ND08234	219	[74405-40-6]	ND08490	263
[55486-09-4]	NM01238	321	[65475-51-6]	NB08969	113	[74405-42-8]	NB10413	98
[55583-59-0]	ND16293	231	[66004-77-1]	ND10280	240	[74405-46-2]	ND09157	186
[55612-11-8]	NT06346	378	[66048-53-1]	NT05368	373	[74686-78-5]	NT11483	359
[55612-21-0]	NF65022	274	[66191-23-9]	NM29024	324	[74784-45-5]	NM11407	333
[55612-21-0]	ND07901	198	[66212-83-7]	NM29026	324	[74804-12-9]	NA44288	27
[55612-39-0]	NG31507	283	[66323-44-2]	NA06398	89	[74829-55-3]	NT45806	373
[55627-73-1]	NB08274	127	[66323-46-4]	NA06550	90	[74848-84-3]	NT08812	365
[55672-92-9]	NC47123	154	[66323-49-7]	NA02832	51	[74925-81-8]	NA76379	16
[55697-38-6]	NA31000	68	[66335-38-4]	ND04700	196	[75059-22-2]	ND15616	192
[55726-47-1]	NE05152	267	[66335-39-5]	ND06334	199	[75431-54-8]	NA15774	23
[55727-10-1]	NM06560	325	[66384-66-5]	NT11494	375	[75479-64-0]	NM01973	319
[56001-37-7]	NG01208	285	[66521-66-2]	NP57381	346	[75520-41-1]	NA46990	13
[56039-11-3]	ND30048	168	[66840-02-6]	ND09528	204	[75522-97-3]	ND57347	229
[56187-37-2]	ND70436	237	[66840-02-6]	ND157275	203	[75607-67-9]	NF01485	274
[56632-58-7]	NU12797	380	[66981-23-5]	NC29022	151	[75763-51-8]	NA05779	47
[56632-83-8]	ND08343	193	[66983-94-6]	NR04851	349	[75833-38-4]	NC57397	152
[56734-11-3]	NM44265	305	[67219-55-0]	NB02600	101	[75985-45-4]	NP57370	347
[56883-05-7]	NP57529	329	[67313-23-9]	ND08739	231	[76360-92-4]	NP57390	306
[56964-73-9]	NH08020	290	[67410-65-5]	NA09785	77	[76512-82-8]	ND57360	249
[56973-12-7]	NM08548	310	[68141-45-7]	NN11481	331	[76748-73-7]	NA44465	55
[57072-36-3]	ND157876	248	[68200-68-0]	ND16029	209	[76902-49-3]	NB31303	97
[57100-18-2]	NP63334	345	[68244-58-6]	NO71879	338	[76939-46-3]	NB07971	122
[57100-20-6]	NP63439	345	[68245-91-0]	ND145452	191	[77210-26-5]	NF58426	279
[57165-33-0]	ND58308	169	[68357-16-4]	ND86951	191	[77378-04-2]	ND10015	219
[57198-02-4]	NR10396	349	[68498-25-9]	NE06241	270	[77378-05-3]	ND10013	217
[57294-74-3]	NA07954	43	[68726-28-3]	ND32065	243	[77378-06-4]	ND10014	212
[57500-07-9]	NB11740	117	[68892-41-1]	ND02998	186	[77710-57-7]	ND10434	177
[57817-83-1]	NM157460	320	[68892-42-2]	ND02989	211	[78582-17-9]	ND57491	165
[57944-13-5]	NF31830	277	[69075-42-9]	NE31862	273	[78635-98-0]	ND16367	212
[58056-57-8]	NA05656	24	[69123-94-0]	ND58418	195	[78687-39-5]	NN31173	334
[58461-30-6]	NC29834	142	[69123-94-0]	ND06062	194	[78842-13-4]	ND02828	197
[59495-21-5]	NE07197	272	[69123-98-4]	ND08477	194	[78859-42-4]	NF08012	279
[59587-07-4]	NA07332	80	[69256-17-3]	ND11876	194	[79154-57-7]	NB09330	113
[59892-36-3]	NR04848	351	[69304-38-7]	NT08582	356	[79896-97-2]	NA08318	73
[59892-40-9]	NR04971	352	[69304-42-3]	NT08581	355	[79999-39-6]	NT20146	370
[60129-59-1]	ND02936	165	[69304-43-4]	NB12322	113	[80015-76-5]	NA03340	47
[60136-25-6]	NI16765	298	[69304-44-5]	NT08583	355	[80049-87-2]	ND06005	198
[60209-41-8]	NM32281	311	[69304-45-6]	NT08580	355	[80681-25-0]	NI57535	211
[60414-59-7]	NP57408	340	[69304-47-8]	NB03851	129	[80791-87-3]	NA06394	58
[60731-47-7]	NA71640	79	[69504-07-0]	NT57542	94	[80875-87-2]	ND32070	172
[60921-30-4]	NA02579	86	[69504-13-8]	NB15545	129	[80902-28-9]	ND32068	206
[60966-26-9]	NA05235	47	[69504-14-9]	NB15546	129	[81012-86-4]	NA57349	25
[61093-23-0]	NC46014	157	[69655-05-6]	ND02929	244	[81012-87-5]	NC03860	161
[61135-33-9]	NE08701	272	[69992-10-5]	ND04500	228	[81012-87-5]	NC66105	161
[61363-29-9]	NA09017	53	[70284-47-8]	NA03451	10	[81012-88-6]	NI10027	292
[61671-80-5]	NF06416	278	[70318-62-6]	NM71742	325	[81012-94-4]	NC04681	139
[61787-04-0]	NF04766	278	[70580-87-9]	NA144615	385	[81144-43-6]	ND57359	249
[61787-05-1]	ND02642	198	[70580-88-0]	NA139017	89	[81246-76-6]	NB04589	108

CAS	Product Code	Page	CAS	Product Code	Page	CAS	Product Code	Page
[81246-79-9]	ND08927	265	[95648-77-4]	ND46159	208	[108392-03-6]	NN29116	332
[81246-80-2]	NB15303	132	[95648-78-5]	NT13491	363	[109434-21-1]	NP46144	340
[81246-81-3]	NB33743	132	[96022-82-1]	ND02491	167	[109464-23-5]	NB01948	103
[81246-82-4]	NB07167	107	[96102-27-1]	NT57548	357	[109679-54-1]	NP28800	341
[81256-87-3]	NB15302	96	[96206-92-7]	NM66689	321	[109909-44-6]	ND05687	176
[81256-88-4]	NB15524	95	[96392-15-3]	ND11705	247	[109909-44-6]	ND46291	164
[81265-93-2]	NB15297	95	[96736-11-7]	NN11350	336	[109909-44-6]	ND46296	266
[81279-39-2]	ND57513	250	[96964-90-8]	NB06296	117	[109909-44-6]	ND46295	266
[81336-74-5]	NA10201	29	[97219-04-0]	ND72055	235	[109909-44-6]	ND46294	265
[81352-25-2]	ND15508	255	[97224-58-3]	ND06187	166	[110143-10-7]	NA05179	51
[81356-82-3]	NC04756	149	[97403-87-7]	NG11482	287	[110457-87-9]	NA145593	48
[81487-28-7]	NC13474	161	[97540-22-2]	NA08266	28	[110505-75-4]	NT30291	368
[81487-29-8]	NC03937	161	[97614-47-6]	ND58420	233	[110505-76-5]	NT30283	367
[81570-50-5]	NG58207	285	[97952-36-8]	NG09615	285	[110522-47-9]	ND06468	228
[81633-29-6]	NE57416	270	[98046-67-4]	NG07984	287	[110522-74-2]	ND09200	218
[81790-82-1]	NB29594	94	[98056-69-0]	ND09159	187	[110522-75-3]	ND02994	211
[81794-12-9]	NB15555	131	[98276-75-6]	NM57401	321	[110522-82-2]	ND08050	188
[81794-13-0]	NB15553	131	[98495-56-8]	ND08981	221	[110558-30-2]	ND22464	236
[81921-35-9]	NM10586	309	[98704-19-9]	NA73270	55	[110764-72-0]	NB08555	108
[82989-82-0]	NA01454	57	[99171-23-0]	NA57372	61	[110764-74-4]	NB08370	109
[83480-48-2]	NF17964	278	[99492-83-8]	NU16887	380	[112131-73-4]	NA32072	35
[84138-86-3]	NB31304	100	[99844-02-7]	NA57406	57	[112131-73-4]	NA46887	35
[84283-08-9]	ND11672	207	[99891-31-3]	NF16547	274	[112501-53-8]	ND10367	187
[84366-81-4]	NR35410	350	[100403-24-5]	ND35412	221	[112898-15-4]	NB29594	94
[84445-38-5]	ND10276	246	[100644-70-0]	NA14388	77	[113886-70-7]	NM06424	320
[84472-85-5]	NA05737	91	[100898-62-2]	ND02997	186	[113886-71-8]	NA08375	19
[84472-90-2]	NA05183	50	[100898-63-3]	NA04015	15	[114745-26-5]	ND03004	259
[84828-97-7]	NT31833	355	[101020-79-5]	NA58198	28	[114748-57-1]	ND72414	245
[85079-00-1]	NB57530	111	[101515-08-6]	ND157323	166	[114748-67-3]	ND57362	168
[85267-67-0]	NH15515	289	[101515-08-6]	ND157324	166	[114748-70-8]	ND44800	168
[85326-06-3]	ND04069	243	[101565-95-1]	NM30295	308	[114834-02-5]	NC57449	147
[85335-73-5]	NT57555	20	[102029-52-7]	NA47206	10	[114952-97-5]	NM01238	321
[85562-55-6]	NC03342	142	[102029-53-8]	NA143918	30	[115388-94-8]	ND144749	188
[85979-49-3]	NA57405	54	[102029-54-9]	NP46146	341	[115389-03-2]	ND08049	218
[86163-17-9]	NC08275	136	[102029-73-2]	NA15698	23	[115479-39-5]	NC06335	141
[86234-45-9]	NB02459	101	[102029-87-8]	NA45874	23	[115479-40-8]	NB10265	132
[86392-74-7]	ND06168	167	[102029-93-6]	NA30684	20	[115794-55-3]	NT57550	357
[86392-75-8]	ND02887	166	[102029-96-9]	NA05778	29	[116154-74-6]	NA17376	64
[86562-85-8]	NA04017	28	[102731-45-3]	ND06109	168	[116285-77-9]	NC03330	147
[86867-01-8]	NA29499	28	[102783-50-6]	ND46693	174	[116295-90-0]	NU35409	381
[87190-81-6]	NA05652	51	[102783-74-4]	ND31607	205	[116840-18-7]	NA32074	34
[87418-35-7]	ND080474	241	[102814-03-9]	ND05424	206	[117136-35-3]	NB16515	133
[87818-06-2]	NF77568	278	[102814-05-1]	ND46691	175	[117517-20-1]	ND61411	198
[87865-78-9]	NI09331	297	[102814-06-2]	ND45194	223	[117778-38-8]	NN64048	158
[87980-17-4]	NA02924	35	[102814-08-4]	ND08736	224	[118353-05-2]	NC16517	136
[88183-82-8]	NT16564	356	[102832-10-0]	ND05758	172	[118353-34-7]	NC58206	161
[88847-89-6]	ND06344	218	[103192-47-8]	NG07985	287	[118373-61-8]	NA31237	40
[88891-75-2]	NP57371	347	[103226-10-4]	ND15883	203	[118905-01-4]	NC29202	136
[89705-21-5]	NA72432	60	[103251-38-3]	NA145308	63	[119340-53-3]	NC11582	156
[89793-11-3]	NM57398	313	[103251-39-4]	NA145311	46	[119555-47-4]	ND89820	242
[90301-67-0]	ND61524	209	[103285-22-9]	ND03001	261	[119644-22-3]	NC58336	145
[90597-22-1]	NC58281	158	[103285-24-1]	ND08420	260	[119794-61-3]	NA57543	11
[90662-86-5]	NC141773	156	[103882-85-5]	NE22706	268	[119803-27-9]	NA30262	76
[90899-89-1]	NM06321	358	[103884-98-6]	ND08478	193	[119824-66-7]	NP45047	339
[91713-46-1]	NC06411	143	[104291-17-0]	ND57492	165	[120225-64-1]	NA10419	54
[91713-51-8]	ND16703	254	[104375-88-4]	ND08238	185	[120225-75-4]	NC16518	145
[92562-88-4]	ND06059	242	[104409-41-8]	ND157322	215	[120225-76-5]	NB16642	129
[92586-35-1]	NA32049	87	[104461-06-5]	NB57438	134	[120360-48-7]	NT29597	377
[92999-29-6]	NH137606	291	[104522-82-2]	NB03006	103	[120595-72-4]	ND02926	41
[93134-41-9]	NI06927	211	[104579-03-5]	ND57348	249	[120912-54-1]	ND08934	237
[93602-66-5]	NA08995	22	[105659-32-3]	NT15543	370	[121032-29-9]	NN26176	331
[93778-57-5]	ND08417	185	[105784-83-6]	ND07998	245	[121055-53-6]	ND16718	190
[93780-25-7]	NE16543	268	[105931-36-0]	NX65210	384	[121058-82-0]	NA11105	18
[93882-12-3]	NC10429	151	[106449-56-3]	ND10029	220	[121058-85-3]	NA11979	12
[93919-41-6]	ND06585	206	[107036-56-6]	ND08404	245	[121288-39-9]	NA07175	32
[93939-70-9]	ND32077	240	[107036-62-4]	ND99344	242	[121353-92-2]	ND144733	217
[93939-70-9]	ND10279	239	[108320-91-8]	NT156795	364	[122111-03-9]	ND09343	178
[94048-47-2]	ND16525	209	[108321-21-7]	NP47204	344	[122406-02-4]	ND45438	244
[94741-69-2]	NA44321	42	[108321-54-6]	NU07988	382	[122406-02-4]	ND10277	244
[94825-44-2]	NG63193	286	[108322-12-9]	NT07359	362	[122567-97-9]	NB15927	112
[95058-80-3]	ND21055	179	[108347-83-7]	NM157477	313	[122799-38-6]	ND03465	200
[95058-81-4]	ND04237	178	[108347-84-8]	NM59495	304	[122929-22-0]	ND63201	243
[95261-09-9]	NB74991	97	[108347-84-8]	NM47199	303	[122970-43-8]	NO02817	338

CAS	Product Code	Page	CAS	Product Code	Page	CAS	Product Code	Page
[123075-23-0]	ND30844	212	[136834-21-4]	NB08366	102	[158042-39-8]	NB09266	105
[123318-82-1]	NA07154	40	[136846-20-3]	NE22731	268	[158966-44-0]	ND06453	234
[123334-07-6]	NC44276	162	[137017-45-9]	ND63556	205	[159414-97-8]	NA02623	16
[123334-75-8]	ND157192	195	[137530-41-7]	NE16704	267	[159414-98-9]	NA06052	15
[123402-20-0]	ND15613	196	[137629-34-6]	ND45438	244	[160385-87-5]	NC10428	151
[123402-21-1]	ND10826	197	[137896-02-7]	NA04442	10	[161109-76-8]	ND10387	229
[123956-65-0]	NA15518	12	[138685-83-3]	NC16645	138	[161110-00-5]	NB02825	98
[124182-57-6]	NC10755	137	[138685-99-1]	NB14259	121	[161110-05-0]	ND05370	223
[124431-80-7]	NC16650	137	[139756-21-1]	NE16544	270	[161308-39-0]	NM46113	316
[124680-51-9]	ND144732	217	[139757-68-9]	NE22708	269	[161599-46-8]	ND05721	227
[124830-99-5]	NC19632	134	[140158-13-0]	NA13340	92	[161923-50-8]	NC04527	146
[125225-72-1]	NZ30353	384	[140712-79-4]	NB06925	99	[162204-20-8]	ND04660	227
[125291-17-0]	ND02828	197	[140712-81-8]	ND06928	186	[162204-30-0]	ND16527	199
[125515-31-3]	NB138534	110	[141018-25-9]	NI04752	295	[162239-35-2]	NE16541	267
[125515-31-3]	NB138670	112	[141018-26-0]	NC05725	137	[162936-24-5]	NE03797	271
[126004-13-5]	NE07194	272	[141018-29-3]	NE06317	271	[163042-96-4]	NC30706	147
[126128-41-4]	ND145588	180	[141771-78-0]	NC02987	143	[163252-36-6]	NC09470	153
[126128-42-5]	ND145587	220	[142038-30-0]	NA16594	53	[163759-49-7]	NM57538	307
[126128-43-6]	ND145589	188	[142217-69-4]	NE10532	267	[163759-50-0]	ND36302	259
[126138-81-6]	NA16502	32	[142217-77-4]	NA32025	38	[166247-63-8]	ND06190	167
[126502-10-1]	ND45441	246	[142554-22-1]	ND02989	211	[167962-39-2]	NR76131	350
[126922-60-9]	ND57510	256	[142784-25-6]	NA04649	58	[168427-74-5]	NM16784	306
[127634-20-2]	NB08953	123	[142948-08-1]	NB08306	106	[170236-33-6]	NA146469	81
[127753-52-0]	NA15338	88	[143157-27-1]	ND16691	233	[170379-51-8]	NM04903	316
[128219-81-8]	ND04071	261	[143491-54-7]	NC05645	155	[170428-84-9]	ND45198	224
[128219-84-1]	ND08419	260	[143491-57-0]	NC05645	155	[170428-86-1]	ND45196	224
[128524-26-5]	ND32064	222	[143653-60-8]	NA31581	11	[170784-58-4]	ND145454	197
[129054-67-7]	NB61549	104	[144490-02-8]	ND02766	222	[170874-47-2]	NF76129	276
[129618-40-2]	NN15304	331	[144640-75-5]	ND16695	229	[171486-53-6]	ND157230	385
[129732-90-7]	NB16627	116	[144742-33-6]	NA06399	11	[171800-68-3]	NM63886	336
[129735-00-8]	NB13568	122	[144796-96-3]	NA46541	36	[172015-79-1]	NA17659	42
[129778-58-1]	NP06246	344	[145918-75-8]	NT29825	378	[172163-62-1]	ND02147	167
[130306-02-4]	ND10202	200	[146629-34-7]	NT16878	377	[172361-60-3]	ND31008	181
[130645-48-6]	NB44336	128	[146954-74-7]	ND06064	184	[172361-60-3]	ND08309	181
[130676-57-2]	ND76817	238	[147058-39-7]	ND157001	242	[172722-76-8]	NM14097	321
[130676-58-3]	NA08461	17	[147126-75-8]	NA32529	54	[172965-92-3]	ND08925	262
[130860-11-6]	NB16514	133	[147127-20-6]	NP11733	341	[173256-61-6]	NC06415	144
[130860-12-7]	NB16513	130	[147212-86-0]	NA04493	63	[173379-73-2]	NA32213	85
[130983-87-8]	NT57556	356	[147218-60-8]	NA09018	55	[173602-25-0]	NL27534	301
[131265-35-5]	NA44903	84	[148296-43-9]	NT46685	363	[173829-09-9]	NL34824	301
[131474-72-1]	NP45046	339	[148390-55-6]	NA11237	10	[175137-25-4]	NF57447	279
[131865-85-5]	NF16548	279	[148608-53-1]	NF63557	281	[175202-75-2]	NT57413	358
[131865-88-8]	NC16521	150	[148892-91-5]	NG35450	284	[175202-77-4]	NF57412	308
[131865-99-1]	NN16559	330	[149022-20-8]	NA10369	25	[175203-08-4]	NC44282	150
[131933-18-1]	NC16523	157	[149624-20-4]	ND89871	193	[175737-77-6]	NB29547	312
[132194-28-6]	ND10205	246	[149624-26-0]	ND89208	193	[177086-37-2]	ND06060	183
[132308-19-1]	NC06914	152	[149771-09-5]	NE57446	270	[178374-44-2]	ND02126	243
[132471-87-5]	NA145312	45	[149806-11-1]	NE57429	342	[178687-87-1]	NF58423	277
[132619-66-0]	ND32066	240	[149965-92-4]	NF04428	280	[178809-71-7]	ND45195	232
[132628-16-1]	NP06294	339	[150206-15-8]	NA06393	57	[179762-50-6]	NB139124	123
[133256-51-6]	NA57403	42	[150424-94-5]	NA06324	83	[180420-84-2]	ND06396	220
[133525-01-6]	NA06316	86	[150668-55-6]	NI61633	298	[182007-86-9]	NB57544	132
[134111-32-3]	ND63588	221	[151151-31-4]	ND46696	172	[182495-80-3]	ND71638	199
[134111-35-6]	NT57661	359	[151151-32-5]	ND16677	174	[182496-01-1]	NB36300	198
[134217-15-5]	NF11536	277	[151345-35-6]	NT11637	34	[183293-80-3]	ND07901	108
[134367-01-4]	NF139015	275	[151520-86-4]	ND139290	177	[185398-21-4]	NT57545	95
[134379-77-4]	NF58422	278	[151823-14-2]	NS29828	353	[185971-89-5]	NF16725	275
[134444-47-6]	NA05649	46	[151837-09-1]	NA08993	22	[187035-79-6]	NE57448	271
[134678-17-4]	NL06295	302	[151898-26-9]	NB05042	123	[187100-75-0]	NM63223	329
[134680-32-3]	NE22686	268	[152918-18-8]	NI10756	294	[188062-50-2]	NA10019	9
[134790-39-9]	ND08303	233	[152918-32-6]	NB06327	116	[188559-94-6]	NE16712	268
[134790-40-2]	NE16710	268	[153286-94-3]	NE44302	272	[188781-08-0]	NE57420	271
[134811-22-6]	NA66851	78	[153381-14-7]	ND10802	179	[191421-10-0]	ND10031	220
[135041-23-5]	NA10196	59	[153512-23-3]	ND08236	265	[191474-13-2]	ND03508	255
[135197-63-6]	ND04744	203	[153631-19-7]	ND08567	260	[192869-80-0]	NB57451	116
[135352-71-5]	ND57427	247	[154321-60-5]	NA57407	62	[193092-29-4]	NT16879	370
[135598-68-4]	NC29827	156	[154361-50-9]	ND09160	201	[195442-55-8]	NA04481	58
[135656-35-8]	ND63590	221	[154925-95-8]	NB16512	120	[195442-56-9]	NA06698	53
[136470-77-4]	NA16495	9	[154934-97-1]	NE57399	272	[197305-97-8]	NH44264	288
[136470-78-5]	NA10018	9	[155957-43-0]	NF57411	279	[199593-08-3]	NA03000	18
[136470-79-6]	NE16540	267	[156357-18-5]	NC76633	143	[200562-12-5]	ND145163	232
[136777-48-5]	NA10019	9	[156592-88-0]	ND16531	253	[201996-57-8]	NC34301	138
[136834-20-3]	NB46150	104	[156592-92-6]	ND22570	253	[201996-62-5]	NU34299	155

## CAS Index

CAS	Product Code	Page	CAS	Product Code	Page	CAS	Product Code	Page
[202065-25-6]	NT57365	373	[443642-47-5]	NB14095	128	[914361-76-5]	NH138533	290
[202186-97-8]	ND09529	197	[443642-48-6]	NM14094	323	[915399-37-0]	NA46160	50
[202533-73-1]	NT61635	356	[443642-53-3]	NM14093	321	[915920-13-7]	NB57433	134
[205171-05-7]	NC14079	150	[443642-54-4]	NB14091	121	[915920-24-0]	NB57434	353
[205171-06-8]	NC14080	158	[443642-55-5]	NC14090	149	[921769-65-5]	NC16644	135
[205368-54-3]	NM46114	317	[443642-56-6]	NA14089	59	[921939-12-0]	NT57436	358
[207131-16-6]	NM08152	317	[443678-71-5]	ND16534	237	[922508-26-7]	NT57546	132
[207724-65-0]	ND63210	255	[444020-09-1]	ND15622	215	[929904-98-3]	NA145468	76
[207920-78-3]	NH44934	290	[444020-64-8]	ND15620	216	[930414-19-4]	ND14100	216
[209216-23-9]	NE10532	267	[444020-69-3]	ND144927	215	[935666-88-9]	NC44330	146
[210829-30-4]	NC05399	281	[444717-20-8]	ND10366	188	[936250-22-5]	NA57424	61
[211245-56-6]	NM57378	324	[444717-23-1]	NB09438	122	[936327-10-5]	NA46883	35
[211694-25-6]	ND10106	242	[445489-49-6]	NN15702	334	[936827-87-1]	NP46906	341
[213136-12-0]	ND58419	233	[469887-93-2]	NA35434	74	[937796-10-6]	NP57437	348
[213136-14-2]	NT08919	377	[473278-54-5]	NM57537	306	[938448-87-4]	NC11728	235
[215943-79-6]	ND06322	230	[476371-76-3]	NA16507	38	[939028-75-8]	NA63574	24
[219982-12-4]	ND59462	163	[476371-80-9]	NA16508	38	[944901-13-7]	NI57443	300
[220458-89-9]	NM70420	320	[476371-81-0]	NA16506	59	[946511-29-1]	NM46513	320
[220793-03-3]	ND07902	194	[477205-38-2]	ND145590	221	[946707-17-1]	NF44320	279
[223777-15-9]	NM16314	307	[477859-71-5]	NM57409	322	[946853-27-6]	NT30285	367
[244105-55-3]	NM36299	307	[478511-11-4]	NU34300	156	[950649-19-1]	NP57382	342
[244226-72-0]	NT29844	363	[478511-19-2]	NC34302	138	[953089-09-3]	NT28569	369
[251647-48-0]	NB16316	111	[496809-83-7]	NA45439	90	[954226-94-9]	NP57439	346
[251647-49-1]	NB36301	108	[510774-50-2]	NC10431	151	[956139-16-5]	NB138535	110
[251647-50-4]	ND31620	259	[537367-25-9]	NB67409	123	[956139-16-5]	NB138671	112
[251647-51-5]	ND76851	260	[594860-43-2]	NI16557	300	[956139-18-7]	NM58201	93
[252337-58-9]	NT57552	357	[622785-69-7]	ND02886	204	[956139-21-2]	NB58202	96
[252337-59-0]	ND08237	265	[634207-53-7]	NC10431	151	[956139-23-4]	NI76867	297
[252337-60-3]	NA08232	54	[640725-69-5]	NT06137	373	[956139-30-3]	NT58203	366
[256953-68-1]	NA16503	44	[642460-95-5]	NA145592	59	[959240-13-2]	NC57440	158
[267668-71-3]	NA16496	9	[652154-13-7]	NC03860	161	[959240-19-8]	NF57441	281
[285978-18-9]	NU03863	381	[666848-11-9]	NB08949	134	[959240-25-6]	NM57442	307
[285978-18-9]	NU10275	381	[676556-11-9]	NB63589	125	[959240-72-3]	NB44324	127
[290371-75-4]	ND11574	251	[690269-86-4]	NM144529	323	[1000203-40-6]	NT76128	373
[303173-39-9]	NA05715	58	[690619-43-3]	NP57377	347	[1011529-10-4]	NA32212	85
[305808-19-9]	NB06336	97	[698999-85-8]	NN11662	332	[1015856-32-2]	NC57384	158
[307314-30-3]	ND63443	255	[769951-32-8]	NA44317	62	[1018812-31-1]	NB09417	96
[307496-37-3]	ND44271	231	[778611-78-2]	NB139126	115	[1027764-72-2]	ND58417	194
[312693-72-4]	ND06306	205	[797804-87-6]	ND08403	241	[1028723-99-0]	NB139123	131
[313348-27-5]	NR07283	348	[811431-33-1]	NC07451	138	[1033194-54-5]	NB57391	117
[318250-11-2]	ND45968	175	[817204-32-3]	NB98842	104	[1033194-60-3]	NM57392	325
[327174-86-7]	NM11441	314	[828247-65-0]	NT57554	20	[1044589-82-3]	ND15347	168
[328394-26-9]	NB18375	115	[832741-25-0]	NB57410	128	[1116020-97-3]	NM29545	311
[332359-99-6]	NB28930	126	[847551-00-2]	NI14087	295	[1145869-46-0]	NA32210	85
[336881-26-6]	ND03507	202	[847551-25-1]	NB14088	121	[1159990-37-0]	NA145309	62
[337536-53-5]	NN03322	335	[847551-58-0]	NC14083	147	[1166395-05-6]	NA145600	48
[343781-45-3]	NB67655	126	[847647-94-3]	ND71635	199	[1187058-40-7]	NL24831	302
[345909-25-3]	NT04480	360	[847650-50-4]	ND144925	216	[1187058-41-8]	NL24830	301
[347418-42-2]	NC57386	146	[847651-91-6]	NM14086	323	[1187058-42-9]	NL15940	302
[347841-67-2]	NT29046	366	[849214-04-6]	NC137624	157	[1189482-51-6]	NB44334	127
[352195-40-5]	NI02985	292	[852235-06-4]	NA04723	66	[1189743-60-9]	NB16032	288
[356782-84-8]	ND31834	248	[856702-89-1]	NC63575	157	[1215787-31-7]	NH44335	123
[357638-55-2]	ND145594	220	[863329-66-2]	ND29433	200	[1220515-68-3]	NP145591	343
[359436-55-8]	NI07234	298	[863910-15-0]	ND09158	187	[1220515-75-2]	NA145310	45
[359689-54-6]	ND10527	176	[865474-03-9]	ND08738	228	[1220515-87-6]	NA145313	44
[364613-33-2]	NA146816	11	[866625-10-7]	NA57383	59	[1242061-01-3]	NT30289	367
[372183-70-5]	NC57394	146	[868663-26-7]	NB09418	93	[1244855-59-1]	NB44294	116
[374750-30-8]	NM07819	318	[869355-14-6]	NA146471	77	[1244855-76-2]	NC44293	147
[374750-32-0]	NM14098	319	[869355-16-8]	ND10364	165	[1260902-01-9]	ND59458	247
[378211-85-9]	NP57366	346	[869355-18-0]	ND11336	189	[1261272-24-5]	NA16510	92
[380886-95-3]	ND10527	176	[869355-22-6]	NC08240	136	[1312300-53-0]	ND58415	196
[382137-74-8]	NP08698	348	[869355-24-8]	NC10421	138	[1334145-18-4]	NF137619	276
[384380-52-3]	NA16897	9	[873556-44-6]	NA46263	83	[1355028-82-8]	NA16510	92
[386229-77-2]	NT07359	362	[874676-81-0]	NC70377	147	[1356084-46-2]	NB139125	131
[392326-81-7]	NA57404	39	[876710-73-5]	NM57445	321	[1357354-76-7]	NI58200	296
[401812-97-3]	NA71488	11	[876717-41-8]	NM57430	307	[1365258-17-8]	NA32211	85
[433733-92-7]	NA07017	68	[876890-28-7]	NE57431	272	[1370411-46-3]	NM44338	305
[437715-62-3]	NC06596	143	[876890-33-4]	NP57432	345	[1421336-32-4]	NF58421	277
[443642-29-3]	ND08351	169	[886365-79-3]	NB44319	127	[1422361-25-8]	NF58425	278
[443642-33-9]	NC14084	150	[908130-61-0]	ND06190	167	[1434144-21-4]	ND63066	200
[443642-38-4]	ND08382	169	[909398-18-1]	NO10556	337	[1809315-85-2]	NM29588	311
[443642-40-8]	NA34901	41	[909415-65-2]	ND156947	187			
[443642-46-4]	NC14096	150	[910129-15-6]	ND16526	199			



CAS

Product Code

Page

# Carbosynth



## Lewis Sugars

The antigens of the Lewis system are carbohydrate determinants carried either on proteins or lipids. Although they were first detected on red blood cells (RBCs), the majority of the biochemical studies have been performed on Lewis substances isolated from plasma or saliva. They are assembled by sequential addition of specific monosaccharides onto terminal saccharide precursor chains on glycolipids or glycoproteins. On the erythrocyte surface they reside on glycolipids. In contrast to the other blood group antigens, the synthesis of these glycolipids does not occur in erythroid tissues, but they are acquired by the erythrocyte membranes from other tissues through circulating lipoproteins.<sup>1</sup>

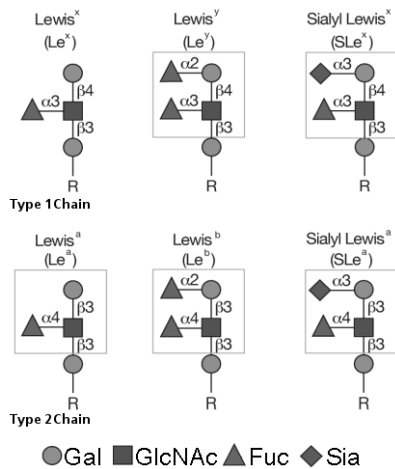

**Figure 1** Schematic structure of the Lewis sugars  
Structure and Biosynthesis of Lewis Sugars

The ABH and Lewis glycoproteins possess a common basic structure and their blood group specificity is determined by the sequence and linkage. There are four Lewis antigens, termed Lewis A ( $Le^a$ ), Lewis B ( $Le^b$ ), Lewis X ( $Le^x$ ) and Lewis Y ( $Le^y$ ). (Product codes OL04541, OL02434, OL06490 and OL06521 respectively.)  $Le^a$  and  $Le^x$  are the product of the action of an  $\alpha$ -1,3-1,4-fucosyltransferase (gene code: FUT3) which adds fucose on the central GlcNAc of the core sugar (see figure 1). If the fucose is added to a type 2 core carbohydrate in an  $\alpha$ -1,4 linkage the resulting product is known

as  $Le^y$ , and if the core is a type 1 chain then the fucose is added via an  $\alpha$ -1,3 linkage and  $Le^x$  is synthesised. (Type 1 chains have a  $\beta$ -1,3 core Gal, whilst type 2 chains possess  $\beta$ -1,4 Gal core).  $Le^b$  and  $Le^y$  antigens are synthesised by the action of a second fucosyl transferase (gene code: FUT2 or Se gene) which adds a second fucose  $\alpha$ -1,2 onto the terminal galactose of the Lewis antigen.<sup>2</sup>

Complete  $Le^b$  or  $Le^y$  sugars cannot be further glycosylated due to steric hindrance but  $Le^a$  or  $Le^x$  is often found sialylated to give sialyl Lewis A ( $sLe^a$ ) and sialyl Lewis X ( $sLe^x$ ) respectively (product codes OS00745 and OS04058).

### Tissue Distribution

As noted above the Lewis antigens are not synthesized in erythrocyte progenitors. The glycolipids that carry the Lewis antigens circulate in plasma either bound to serum lipoproteins or in the form of aqueous dispersions and can become adsorbed to the erythrocyte by a passive adsorption process.<sup>1</sup> The synthesis of Lewis glycans occurs predominantly in epithelial cells, mostly of endothelial origin and the digestive track is probably a major, but not exclusive, site of Lewis antigen synthesis. Lewis and related antigens may also occur as free oligosaccharides in milk and urine or may be protein-bound in a variety of tissues.

Surprisingly red blood cells from newborns are neither Lewis A nor B regardless of their genetic makeup as their cells have not had time to adsorb Lewis antigens from the plasma.<sup>3</sup>

### Clinical Relevance of Lewis Antigens

Immuno-histochemical studies on tumour specimens have shown that  $Le^x$  and  $Le^a$  structures are frequently over-expressed in carcinomas, being carried on O-glycans as well as on N-glycans and glycosphingolipids. In fact  $sLe^x$  and  $sLe^a$  were first identified as tumour antigens<sup>4</sup> rather than blood antigens. The expression of these antigens by epithelial carcinomas correlates with tumour progression, metastatic spread, and poor prognosis in humans, and metastatic potential in mice. Since  $sLe^x$  and  $sLe^a$  can bind to the selectins involved in cell adherence and immune stimulation it is reasonable to postulate that any tumour cells expressing  $sLe^x$  and  $sLe^a$  have an advantage in metastasis and immune avoidance<sup>5</sup>.

The discovery that *Helicobacter pylori* (the causative agent in gastritis, peptic ulcers and gastric carcinoma) uses a fucose of  $Le^b$  as a receptor to establish infection<sup>6</sup> has stimulated research in the role of Lewis status in many diseases of the GI tract.

Lewis antigens have also been implicated as having a role in transplant immunology as studies suggest those transplant patients who are  $Le^a$  and  $Le^b$  negative have shorter transplant survival times than those who have a Lewis gene.<sup>7</sup>

### References:

- Marcus D. M. Cass L. Science, 1969, 164, 879.
- Stanley and Cummings, Structures Common to Different Glycans in Essentials of Glycobiology. 2nd Ed. 2006 Edited by Ajit Varki, Cold Spring Harbor Laboratory Press, USA
- Ameno S, et al. Biol Neonate, 2001, 79, 91
- Hakomori S. Chem. Phys. Lipids. 1986, 42, 209.
- Takada A et al. Cancer Res. 1993, 53(2), 354.
- Bořen T, et al. Proc Natl Acad Sci 1993, 90(5):2035.
- Roy R, et al. Transplant Proc. 1987 19(6), 4498

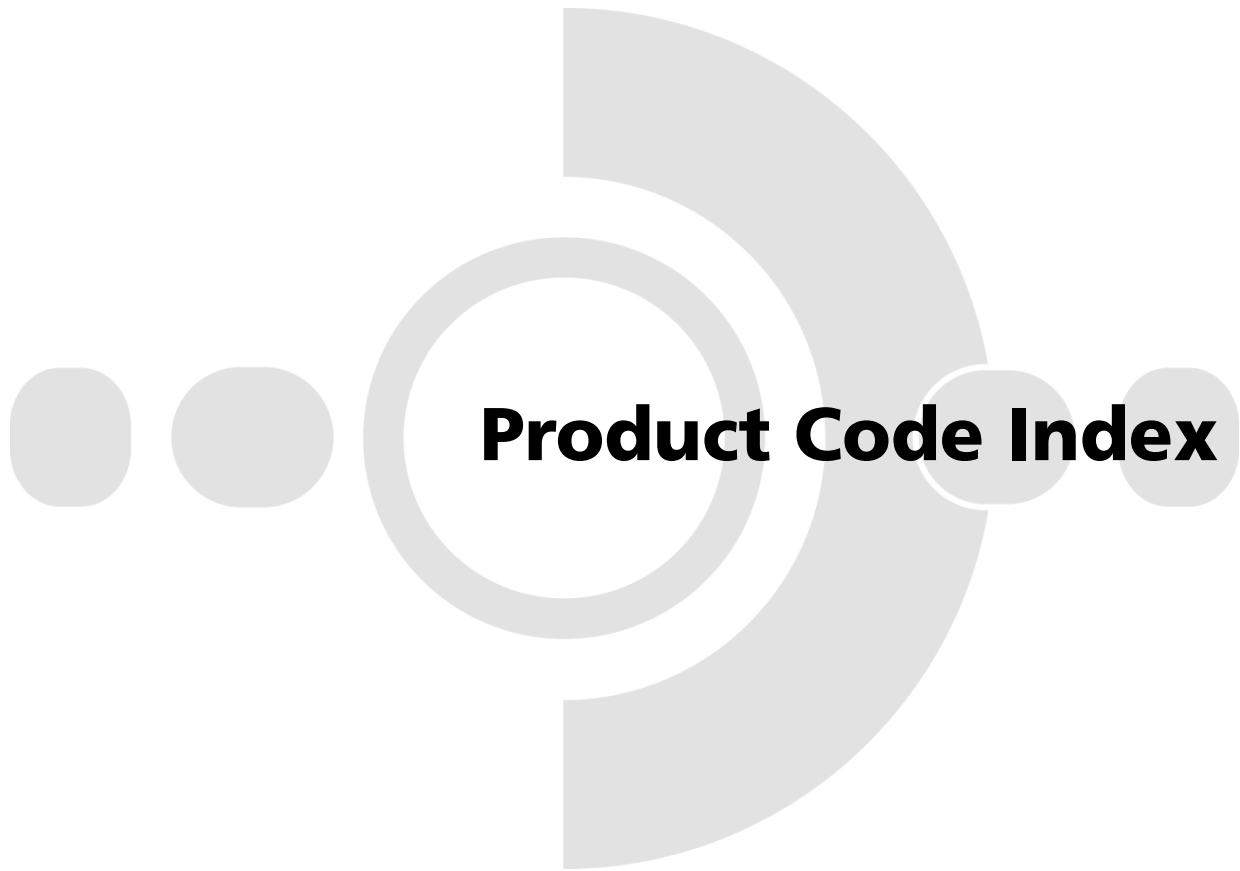

# Product Code Index

## Product Code Index

Product Code	Page	Product Code	Page	Product Code	Page	Product Code	Page	Product Code	Page
NA00135	26	NA05753	13	NA08215	38	NA09234	66	NA141793	77
NA00714	68	NA05771	73	NA08216	40	NA09235	66	NA141794	77
NA01454	57	NA05778	29	NA08231	53	NA09238	82	NA14388	77
NA01639	27	NA05779	47	NA08232	54	NA09239	85	NA143918	30
NA01967	67	NA05780	73	NA08256	69	NA09240	86	NA144615	385
NA02525	48	NA05939	69	NA08263	13	NA09241	79	NA145111	77
NA02562	17	NA05962	75	NA08266	28	NA09329	20	NA145308	63
NA02579	86	NA06002	74	NA08269	52	NA09398	44	NA145309	62
NA02623	16	NA06007	72	NA08316	37	NA09399	45	NA145310	45
NA02636	45	NA06023	80	NA08318	73	NA09400	46	NA145311	46
NA02637	45	NA06052	15	NA08319	67	NA09401	41	NA145312	45
NA02698	75	NA06227	27	NA08320	63	NA09402	49	NA145313	44
NA02728	76	NA06237	31	NA08373	78	NA09403	42	NA145468	76
NA02765	79	NA06238	32	NA08375	19	NA09428	84	NA145592	59
NA02790	67	NA06243	32	NA08376	20	NA09429	84	NA145593	48
NA02831	49	NA06245	31	NA08378	50	NA09430	85	NA145600	48
NA02832	51	NA06249	32	NA08395	63	NA09431	88	NA145603	81
NA02915	33	NA06287	45	NA08458	16	NA09572	74	NA145604	43
NA02919	75	NA06300	71	NA08460	15	NA09573	74	NA145605	64
NA02924	35	NA06303	88	NA08461	17	NA09588	11	NA145607	67
NA02925	34	NA06305	69	NA08462	20	NA09599	76	NA145608	66
NA02926	41	NA06316	86	NA08463	12	NA09600	76	NA145610	90
NA02947	76	NA06318	25	NA08525	13	NA09785	77	NA145611	83
NA02969	78	NA06320	68	NA08596	19	NA09884	14	NA145615	79
NA02978	27	NA06324	83	NA08597	14	NA10018	9	NA145616	90
NA02980	69	NA06326	87	NA08655	81	NA10019	9	NA145617	90
NA03000	18	NA06393	57	NA08656	81	NA10080	73	NA145619	82
NA03003	15	NA06394	58	NA08672	80	NA10195	23	NA145740	65
NA03107	59	NA06395	49	NA08673	80	NA10196	59	NA145741	15
NA03336	45	NA06398	89	NA08674	80	NA10201	29	NA146212	21
NA03337	44	NA06399	11	NA08675	81	NA10278	79	NA146469	81
NA03340	47	NA06452	88	NA08676	82	NA10318	14	NA146471	77
NA03401	74	NA06550	90	NA08677	82	NA10355	21	NA146816	11
NA03403	51	NA06674	80	NA08678	82	NA10369	25	NA15183	19
NA03451	10	NA06678	32	NA08679	83	NA10412	88	NA15219	17
NA03463	24	NA06698	53	NA08680	70	NA10419	54	NA15329	73
NA03552	56	NA06711	68	NA08681	70	NA106323	60	NA15330	72
NA03794	17	NA06751	57	NA08684	70	NA106350	27	NA15338	88
NA04015	15	NA06911	24	NA08685	70	NA10682	25	NA15518	12
NA04017	28	NA07017	68	NA08690	71	NA10690	14	NA15556	18
NA04029	19	NA07154	40	NA08692	71	NA10696	23	NA15558	16
NA04201	43	NA07162	65	NA08693	72	NA10698	24	NA15614	12
NA04422	79	NA07163	65	NA08704	70	NA10801	25	NA15619	11
NA04442	10	NA07164	65	NA08705	84	NA11064	81	NA15623	17
NA04479	54	NA07165	65	NA08780	37	NA11105	18	NA15624	16
NA04481	58	NA07175	32	NA08965	41	NA11237	10	NA15698	12
NA04488	62	NA07178	21	NA08991	22	NA11364	63	NA157213	77
NA04493	63	NA07179	26	NA08992	21	NA11484	19	NA15774	23
NA04579	87	NA07204	56	NA08993	22	NA11514	41	NA16030	86
NA04586	86	NA07205	53	NA08994	22	NA11521	52	NA16031	47
NA04601	87	NA07206	52	NA08995	22	NA11588	72	NA16207	92
NA04603	87	NA07207	53	NA08996	23	NA11603	14	NA16291	29
NA04647	39	NA07332	80	NA08999	36	NA11608	14	NA16429	19
NA04648	60	NA07912	51	NA09000	36	NA11629	18	NA16495	9
NA04649	58	NA07921	66	NA09001	36	NA11632	14	NA16496	9
NA04723	66	NA07922	67	NA09002	37	NA11708	63	NA16501	30
NA05071	31	NA07923	66	NA09003	36	NA11979	12	NA16502	32
NA05179	51	NA07924	67	NA09004	40	NA12011	33	NA16503	44
NA05183	50	NA07943	13	NA09005	40	NA12252	46	NA16506	59
NA05212	43	NA07946	29	NA09007	37	NA12253	49	NA16507	38
NA05223	50	NA07954	43	NA09009	38	NA12830	10	NA16508	38
NA05235	47	NA07960	31	NA09010	39	NA13340	92	NA16509	75
NA05270	49	NA07968	71	NA09011	46	NA13520	78	NA16510	92
NA05280	31	NA07969	71	NA09013	47	NA137363	75	NA16594	53
NA05412	84	NA08057	78	NA09014	48	NA137508	55	NA16897	9
NA05630	69	NA08059	74	NA09016	49	NA137608	86	NA17223	28
NA05636	88	NA08202	71	NA09017	53	NA137609	47	NA17231	30
NA05649	46	NA08203	69	NA09018	55	NA137610	90	NA17376	64
NA05652	51	NA08207	82	NA09216	72	NA137611	51	NA17659	42
NA05656	24	NA08208	83	NA09230	64	NA138797	18	NA17929	68
NA05711	33	NA08209	70	NA09231	64	NA139017	89	NA29438	16
NA05715	58	NA08210	36	NA09232	65	NA139066	89	NA29499	28
NA05737	91	NA08211	91	NA09233	66	NA14089	59	NA30262	76

# Product Code Index

NB57451

Product Code	Page	Product Code	Page	Product Code	Page	Product Code	Page	Product Code	Page
NA30542	26	NA57403	42	NB05283	124	NB08967	107	NB15524	95
NA30567	24	NA57404	39	NB05782	124	NB08969	113	NB15545	129
NA30683	20	NA57405	54	NB06159	115	NB08970	113	NB15546	129
NA30684	20	NA57406	57	NB06281	124	NB09205	109	NB15553	131
NA30768	78	NA57407	62	NB06291	93	NB09206	95	NB15555	131
NA30959	64	NA57415	60	NB06296	117	NB09266	105	NB15625	124
NA31000	68	NA57424	61	NB06311	127	NB09330	113	NB15687	124
NA31237	40	NA57522	17	NB06315	126	NB09417	96	NB15927	112
NA31345	22	NA57526	21	NB06325	114	NB09418	93	NB16316	111
NA31536	25	NA57527	13	NB06327	116	NB09433	107	NB16512	120
NA31581	11	NA57543	11	NB06331	109	NB09434	108	NB16513	130
NA31619	27	NA57558	23	NB06336	97	NB09435	109	NB16514	133
NA31829	48	NA57597	25	NB06418	112	NB09436	109	NB16515	133
NA32025	38	NA58152	26	NB06450	124	NB09438	122	NB16621	117
NA32046	87	NA58197	22	NB06917	105	NB09511	119	NB16627	116
NA32049	87	NA58198	28	NB06920	106	NB09533	111	NB16642	129
NA32071	33	NA58205	26	NB06921	106	NB09534	110	NB18375	115
NA32072	35	NA59527	37	NB06922	101	NB09608	133	NB18821	121
NA32073	33	NA63217	27	NB06923	105	NB09916	125	NB28930	126
NA32074	34	NA63420	33	NB06924	106	NB10030	115	NB29023	117
NA32075	34	NA63511	24	NB06925	99	NB10265	132	NB29594	94
NA32210	85	NA63573	24	NB07167	107	NB10283	116	NB30216	114
NA32211	85	NA63574	24	NB07424	130	NB10390	104	NB30742	93
NA32212	85	NA65977	56	NB07971	122	NB10413	98	NB30743	93
NA32213	85	NA66252	25	NB07972	122	NB10414	100	NB31303	97
NA32296	89	NA66773	41	NB07973	126	NB10415	100	NB31304	100
NA32529	54	NA66851	78	NB08023	105	NB10416	98	NB31485	125
NA34795	19	NA67922	41	NB08204	107	NB11607	99	NB31486	125
NA34901	41	NA68095	60	NB08205	130	NB11613	100	NB32052	120
NA35434	74	NA70257	52	NB08212	94	NB11616	99	NB32053	119
NA44281	56	NA70525	55	NB08250	104	NB11617	98	NB32054	120
NA44287	23	NA71089	31	NB08272	130	NB11619	100	NB32055	118
NA44288	27	NA71416	67	NB08274	127	NB11627	99	NB32056	118
NA44301	56	NA71488	11	NB08298	115	NB11641	125	NB32057	118
NA44305	41	NA71640	79	NB08306	106	NB11645	100	NB32058	119
NA44306	57	NA71659	89	NB08321	37	NB11740	117	NB32059	119
NA44317	62	NA71660	89	NB08322	101	NB12322	113	NB32060	119
NA44321	42	NA71661	90	NB08332	111	NB13568	122	NB32061	119
NA44328	43	NA71662	91	NB08333	112	NB137576	112	NB32062	118
NA44465	55	NA71663	91	NB08366	102	NB137578	112	NB32078	119
NA44795	21	NA71664	50	NB08367	103	NB137582	105	NB33743	132
NA44903	84	NA71665	50	NB08368	107	NB137584	105	NB33744	131
NA45439	90	NA71666	51	NB08369	107	NB137588	113	NB33745	96
NA45440	89	NA71667	52	NB08370	109	NB137590	111	NB36300	108
NA45874	23	NA71841	61	NB08371	124	NB137591	111	NB36301	108
NA45920	92	NA72432	60	NB08372	123	NB137592	110	NB39290	99
NA45964	12	NA73270	55	NB08374	97	NB137597	97	NB44268	128
NA46036	39	NA76379	16	NB08465	104	NB137598	97	NB44294	116
NA46037	62	NA76381	18	NB08466	103	NB138534	110	NB44313	128
NA46044	29	NA76382	13	NB08467	102	NB138535	110	NB44319	127
NA46045	30	NA76393	78	NB08469	102	NB138670	112	NB44324	127
NA46068	91	NA76394	78	NB08472	104	NB138671	112	NB44331	117
NA46069	91	NB01918	96	NB08473	102	NB139123	131	NB44334	127
NA46070	91	NB01948	103	NB08474	102	NB139124	132	NB44335	123
NA46160	50	NB02459	101	NB08509	113	NB139125	131	NB44336	128
NA46262	39	NB02564	125	NB08515	93	NB139126	115	NB45915	114
NA46263	83	NB02600	101	NB08526	107	NB139127	131	NB45917	114
NA46264	84	NB02601	100	NB08528	101	NB139128	132	NB46054	99
NA46265	86	NB02825	98	NB08529	99	NB14088	121	NB46055	101
NA46541	36	NB02934	126	NB08544	110	NB14091	121	NB46150	104
NA46695	29	NB02946	125	NB08553	106	NB14095	128	NB46238	118
NA46883	35	NB02991	98	NB08554	106	NB14259	121	NB46239	120
NA46887	35	NB03006	103	NB08555	108	NB143914	127	NB46266	121
NA46990	13	NB03414	123	NB08557	108	NB145599	133	NB46326	96
NA47206	10	NB03505	94	NB08643	130	NB145739	103	NB46819	133
NA48994	10	NB03843	129	NB08646	130	NB145742	109	NB57391	117
NA57349	25	NB03851	129	NB08667	94	NB145743	128	NB57393	354
NA57367	42	NB04589	108	NB08668	94	NB145745	103	NB57410	128
NA57368	61	NB04595	114	NB08718	95	NB145906	105	NB57419	126
NA57372	61	NB04599	115	NB08944	133	NB146140	95	NB57433	134
NA57383	59	NB04668	128	NB08945	133	NB15297	95	NB57434	353
NA57396	58	NB05042	123	NB08949	134	NB15302	96	NB57438	134
NA57402	60	NB05230	116	NB08953	123	NB15303	132	NB57451	116

## Product Code Index

Product Code	Page	Product Code	Page	Product Code	Page	Product Code	Page	Product Code	Page
NB57521	97	NC07420	148	NC44293	147	ND02976	266	ND06301	222
NB57523	114	NC07451	138	NC44308	150	ND02986	228	ND06306	205
NB57524	114	NC07978	140	NC44309	150	ND02989	211	ND06307	225
NB57530	111	NC07979	140	NC44312	149	ND02992	224	ND06319	207
NB57534	104	NC07982	158	NC44314	149	ND02993	175	ND06322	230
NB57544	132	NC07990	163	NC44330	146	ND02994	211	ND06334	199
NB58201	93	NC08239	138	NC45738	158	ND02996	205	ND06344	218
NB58202	96	NC08240	136	NC45965	154	ND02997	186	ND06386	213
NB61549	104	NC08275	136	NC46014	157	ND02998	186	ND06396	220
NB63246	120	NC08279	142	NC46046	162	ND03001	261	ND06413	219
NB63417	95	NC08475	145	NC46163	160	ND03004	259	ND06453	234
NB63548	102	NC09356	159	NC46261	161	ND03361	264	ND06454	210
NB63589	125	NC09380	160	NC47123	154	ND03400	230	ND06468	228
NB64783	134	NC09470	153	NC57355	160	ND03465	200	ND06470	223
NB67066	118	NC09471	154	NC57384	158	ND03507	202	ND06544	204
NB67359	126	NC09808	141	NC57386	146	ND03508	255	ND06551	246
NB67409	123	NC10380	139	NC57394	146	ND04010	172	ND06559	240
NB67655	126	NC10381	139	NC57397	152	ND04011	173	ND06564	177
NB70237	112	NC10383	139	NC57418	152	ND04069	243	ND06585	206
NB71641	127	NC10421	138	NC57423	140	ND04071	261	ND06676	222
NB74991	97	NC10428	151	NC57440	158	ND04228	243	ND06701	235
NB98842	104	NC10429	151	NC57449	147	ND04237	178	ND06741	240
NC00007	161	NC10430	151	NC57576	161	ND04246	173	ND06772	180
NC01366	157	NC10431	151	NC58206	161	ND04495	238	ND06913	233
NC02619	144	NC10755	137	NC58281	158	ND04500	228	ND06914	232
NC02628	162	NC11301	149	NC58336	145	ND04658	227	ND06918	264
NC02866	153	NC11429	159	NC58344	137	ND04660	227	ND06928	186
NC02951	160	NC11515	146	NC58674	158	ND04697	164	ND07075	253
NC02987	143	NC11582	156	NC59484	157	ND04700	196	ND07079	256
NC03330	147	NC11678	159	NC59514	162	ND04704	180	ND07118	239
NC03338	147	NC11680	159	NC63100	135	ND04706	180	ND07899	209
NC03341	140	NC11728	235	NC63104	135	ND04708	251	ND07901	198
NC03342	142	NC13474	161	NC63113	135	ND04743	171	ND07902	194
NC03343	140	NC137624	157	NC63575	157	ND04744	203	ND07992	216
NC03763	142	NC14079	150	NC64061	156	ND04751	208	ND07994	232
NC03860	161	NC14080	158	NC65881	151	ND05147	210	ND07995	233
NC03937	161	NC14083	147	NC66105	161	ND05186	241	ND07996	235
NC04070	162	NC14084	150	NC66914	152	ND05219	230	ND07997	240
NC04077	155	NC14090	149	NC70185	148	ND05330	238	ND07998	245
NC04257	145	NC14096	150	NC70186	152	ND05370	223	ND07999	247
NC04468	159	NC141773	156	NC70377	147	ND05411	193	ND08001	251
NC04527	146	NC15333	154	NC71639	139	ND05424	206	ND08006	190
NC04650	143	NC15334	154	NC76589	141	ND05647	252	ND08018	208
NC04653	144	NC15472	159	NC76633	143	ND05687	176	ND08049	218
NC04680	145	NC15615	143	ND00041	167	ND05721	227	ND08050	188
NC04681	139	NC15795	136	ND01156	253	ND05744	172	ND08228	184
NC04682	148	NC15936	152	ND01970	242	ND05747	177	ND08233	188
NC04688	145	NC16517	136	ND02126	243	ND05750	208	ND08234	219
NC04756	149	NC16518	145	ND02147	167	ND05752	168	ND08235	208
NC04761	148	NC16519	148	ND02399	202	ND05758	172	ND08236	265
NC05369	141	NC16520	149	ND02491	167	ND05774	207	ND08237	265
NC05399	281	NC16521	150	ND02591	174	ND05777	209	ND08238	185
NC05637	160	NC16523	157	ND02599	173	ND05865	216	ND08249	189
NC05644	142	NC16644	135	ND02602	192	ND05963	225	ND08303	233
NC05645	155	NC16645	138	ND02632	184	ND05965	189	ND08309	181
NC05679	153	NC16650	137	ND02642	198	ND05971	171	ND08311	165
NC05725	137	NC19632	134	ND02666	185	ND06005	198	ND08343	193
NC06293	140	NC20534	155	ND02766	222	ND06059	242	ND08348	166
NC06308	142	NC28916	160	ND02776	217	ND06060	183	ND08349	228
NC06328	141	NC29021	152	ND02827	192	ND06062	194	ND08351	169
NC06329	148	NC29022	151	ND02828	197	ND06064	184	ND08382	169
NC06332	135	NC29202	136	ND02835	219	ND06109	168	ND08398	187
NC06333	137	NC29203	136	ND02838	219	ND06168	167	ND08399	225
NC06335	141	NC29204	135	ND02839	217	ND06187	166	ND08402	236
NC06337	141	NC29205	136	ND02886	204	ND06189	196	ND08403	241
NC06411	143	NC29827	156	ND02887	166	ND06190	167	ND08404	245
NC06415	144	NC29834	142	ND02921	204	ND06191	168	ND08405	241
NC06422	144	NC30706	147	ND02927	207	ND06231	214	ND08406	244
NC06562	153	NC32076	162	ND02928	217	ND06236	215	ND08407	245
NC06596	143	NC34301	138	ND02929	244	ND06242	214	ND08408	222
NC06679	146	NC34302	138	ND02930	273	ND06282	225	ND08409	246
NC07342	153	NC44276	162	ND02936	165	ND06286	177	ND08410	226
NC07419	144	NC44282	150	ND02968	204	ND06290	164	ND08411	241

# Product Code Index

ND57359

Product Code	Page	Product Code	Page	Product Code	Page	Product Code	Page	Product Code	Page
ND08414	257	ND09207	330	ND11624	184	ND15508	255	ND31834	248
ND08415	258	ND09248	169	ND11625	265	ND15547	258	ND32045	239
ND08416	186	ND09265	209	ND11626	257	ND15613	196	ND32048	238
ND08417	185	ND09343	178	ND11628	184	ND15616	192	ND32051	245
ND08418	260	ND09415	226	ND11630	264	ND15620	216	ND32064	222
ND08419	260	ND09503	225	ND11631	185	ND15621	188	ND32065	243
ND08420	260	ND09525	193	ND11633	185	ND15622	215	ND32066	240
ND08421	262	ND09526	201	ND11634	189	ND15626	227	ND32068	206
ND08422	258	ND09527	201	ND11635	189	ND15627	227	ND32069	176
ND08423	254	ND09528	204	ND11640	171	ND156947	187	ND32070	172
ND08425	254	ND09529	197	ND11646	263	ND157001	242	ND32077	240
ND08429	263	ND09530	195	ND11672	207	ND157121	215	ND32094	178
ND08477	194	ND09532	191	ND11705	247	ND157123	213	ND32635	180
ND08478	193	ND09536	234	ND11706	248	ND157192	195	ND34656	234
ND08485	234	ND09537	230	ND11876	194	ND157230	385	ND35412	221
ND08486	234	ND09538	230	ND12015	226	ND157275	203	ND35419	251
ND08487	236	ND09546	227	ND13487	174	ND157276	195	ND36302	259
ND08490	263	ND09708	178	ND13488	208	ND157277	197	ND37120	179
ND08516	257	ND09987	243	ND13490	171	ND157322	215	ND44271	231
ND08517	258	ND10012	214	ND13493	191	ND157323	166	ND44280	237
ND08518	258	ND10013	217	ND137579	205	ND157324	166	ND44283	252
ND08519	257	ND10014	212	ND137580	205	ND15747	213	ND44285	252
ND08520	257	ND10015	219	ND137581	205	ND157507	230	ND44286	252
ND08523	198	ND10028	221	ND137583	204	ND157584	212	ND44297	231
ND08524	183	ND10029	220	ND138532	209	ND157876	248	ND44311	248
ND08527	177	ND10031	220	ND138640	238	ND157877	247	ND44800	168
ND08530	210	ND10106	242	ND138641	238	ND15883	203	ND44812	166
ND08533	212	ND10199	196	ND139290	177	ND15970	178	ND45045	226
ND08535	212	ND10202	200	ND14100	216	ND16029	209	ND45194	223
ND08536	212	ND10205	246	ND143189	218	ND16144	179	ND45195	223
ND08541	172	ND10276	246	ND143429	183	ND16293	231	ND45196	224
ND08542	183	ND10277	244	ND144479	191	ND16317	239	ND45197	224
ND08543	245	ND10279	239	ND144597	216	ND16367	212	ND45198	224
ND08558	213	ND10280	240	ND144732	217	ND16524	170	ND45438	244
ND08559	187	ND10281	253	ND144733	217	ND16525	209	ND45441	246
ND08560	218	ND10291	247	ND144749	188	ND16526	199	ND45563	251
ND08561	218	ND10362	259	ND144756	215	ND16527	199	ND45586	211
ND08562	213	ND10364	165	ND144802	201	ND16531	253	ND45638	190
ND08563	221	ND10366	188	ND144816	213	ND16534	237	ND45821	229
ND08564	231	ND10367	187	ND144870	248	ND16676	176	ND45968	175
ND08565	232	ND10387	229	ND144925	216	ND16677	174	ND46056	186
ND08567	260	ND10392	239	ND144927	215	ND16691	233	ND46151	191
ND08568	262	ND10393	243	ND144937	210	ND16695	229	ND46152	256
ND08569	261	ND10394	246	ND145163	232	ND16703	254	ND46153	197
ND08570	260	ND10405	169	ND145452	191	ND16718	190	ND46156	203
ND08586	261	ND10433	190	ND145453	195	ND21055	179	ND46158	256
ND08598	185	ND10434	177	ND145454	197	ND22463	236	ND46159	208
ND08736	224	ND10514	181	ND145455	199	ND22464	236	ND46290	163
ND08738	228	ND10527	176	ND145456	203	ND22570	253	ND46291	164
ND08739	231	ND10585	263	ND145587	220	ND28881	244	ND46292	206
ND08740	232	ND10802	179	ND145588	180	ND29030	236	ND46293	364
ND08887	228	ND10826	197	ND145589	188	ND29039	205	ND46294	265
ND08925	262	ND10841	181	ND145590	221	ND29354	263	ND46295	266
ND08927	265	ND10842	183	ND145594	220	ND29406	206	ND46296	266
ND08933	237	ND11202	223	ND145595	189	ND29433	200	ND46688	171
ND08934	237	ND11257	194	ND145596	265	ND29434	200	ND46691	175
ND08981	221	ND11318	170	ND145598	189	ND29524	192	ND46693	174
ND08983	202	ND11336	189	ND145747	180	ND29525	165	ND46694	175
ND09056	217	ND11522	236	ND145900	170	ND29528	192	ND46696	172
ND09133	181	ND11574	251	ND145905	181	ND29820	241	ND46720	175
ND09135	182	ND11598	252	ND145912	261	ND30048	168	ND46831	250
ND09136	182	ND11599	256	ND145913	229	ND30220	248	ND46856	229
ND09137	182	ND11602	256	ND145914	229	ND30226	248	ND47021	250
ND09138	182	ND11604	264	ND146114	261	ND30844	212	ND47196	170
ND09139	182	ND11605	185	ND146115	264	ND30902	239	ND57347	229
ND09140	183	ND11609	185	ND146470	180	ND31008	181	ND57348	249
ND09157	186	ND11610	264	ND15214	191	ND31362	167	ND57350	250
ND09158	187	ND11611	263	ND15243	208	ND31415	179	ND57351	249
ND09159	187	ND11614	264	ND15298	171	ND31483	203	ND57352	250
ND09160	201	ND11615	184	ND15335	244	ND31484	210	ND57353	249
ND09163	206	ND11618	264	ND153405	224	ND31488	203	ND57357	249
ND09200	218	ND11620	184	ND153424	214	ND31607	205	ND57358	259
ND09204	192	ND11621	184	ND15347	168	ND31620	259	ND57359	249

## Product Code Index

Product Code	Page	Product Code	Page	Product Code	Page	Product Code	Page	Product Code	Page
ND57360	249	ND76392	215	NF17964	278	NH67971	289	NL31906	383
ND57369	249	ND76410	215	NF31487	280	NH71308	291	NL32196	383
ND57427	247	ND76635	198	NF31489	280	NI02225	295	NL34824	301
ND57450	376	ND76817	238	NF31830	277	NI02985	292	NL47197	302
ND57491	165	ND76851	260	NF32079	280	NI03488	296	NL47198	303
ND57492	165	ND78221	202	NF32352	274	NI03500	299	NM00313	320
ND57508	14	ND80474	241	NF44320	279	NI04748	294	NM01238	321
ND57510	256	ND86951	191	NF46155	195	NI04749	293	NM01973	319
ND57511	258	ND89208	193	NF57411	279	NI04752	295	NM02913	313
ND57512	131	ND89820	242	NF57441	281	NI05151	299	NM02922	319
ND57513	250	ND89871	193	NF57447	279	NI05371	300	NM02939	323
ND57519	15	ND99344	242	NF58421	277	NI06120	299	NM02941	318
ND57520	18	NE01669	269	NF58422	278	NI06221	293	NM02964	305
ND57528	254	NE03797	271	NF58423	277	NI06234	295	NM03526	310
ND57532	254	NE04078	270	NF58424	277	NI06297	293	NM03697	311
ND58204	176	NE05152	267	NF58425	278	NI06926	211	NM03720	315
ND58235	259	NE06039	271	NF58426	279	NI06927	211	NM04259	327
ND58306	170	NE06155	270	NF63557	281	NI07234	298	NM04903	316
ND58308	169	NE06241	270	NF65022	274	NI08025	300	NM04922	328
ND58310	169	NE06244	269	NF76129	276	NI08338	297	NM05162	319
ND58413	241	NE06317	271	NF76155	275	NI08521	296	NM05694	310
ND58414	173	NE07194	272	NF77069	275	NI08522	297	NM05757	315
ND58415	196	NE07197	272	NF77568	278	NI08545	299	NM06185	328
ND58416	202	NE07208	271	NG01208	285	NI08571	296	NM06210	322
ND58417	194	NE08701	272	NG02982	284	NI09331	297	NM06229	315
ND58418	195	NE10532	267	NG03522	283	NI09673	293	NM06232	318
ND58419	233	NE153331	267	NG03984	285	NI09674	293	NM06235	322
ND58420	233	NE16540	267	NG05944	286	NI09827	300	NM06239	326
ND59458	247	NE16541	267	NG06314	286	NI09914	298	NM06240	327
ND59462	163	NE16543	268	NG07983	287	NI10022	295	NM06248	327
ND59548	225	NE16544	270	NG07984	287	NI10026	292	NM06302	315
ND59759	263	NE16704	267	NG07985	287	NI10027	292	NM06304	320
ND61411	198	NE16710	268	NG08963	283	NI10382	292	NM06321	358
ND61524	209	NE16712	268	NG08975	283	NI10699	292	NM06424	320
ND63066	200	NE22686	268	NG09355	284	NI10756	294	NM06451	326
ND63201	243	NE22706	268	NG09615	285	NI11887	292	NM06560	325
ND63210	255	NE22708	269	NG09782	283	NI138523	297	NM07256	322
ND63287	201	NE22731	268	NG106386	286	NI138672	296	NM07819	318
ND63288	202	NE29589	269	NG11482	287	NI138673	296	NM07917	310
ND63440	219	NE29590	269	NG145480	283	NI14082	294	NM07918	315
ND63443	255	NE29591	269	NG16741	283	NI14087	295	NM07919	327
ND63471	181	NE30545	273	NG30609	285	NI16557	300	NM08028	308
ND63556	205	NE31862	273	NG30910	284	NI16765	298	NM08030	308
ND63565	200	NE44302	272	NG31507	283	NI24672	298	NM08037	319
ND63588	221	NE44318	270	NG35450	284	NI30240	298	NM08039	326
ND63590	221	NE57380	271	NG40772	284	NI31361	294	NM08152	317
ND63885	249	NE57399	272	NG46689	284	NI36298	293	NM08170	318
ND64692	261	NE57416	270	NG57356	286	NI44327	294	NM08427	321
ND64914	174	NE57420	271	NG57598	284	NI57361	294	NM08548	310
ND66272	232	NE57431	272	NG58207	285	NI57362	168	NM08573	313
ND66563	234	NE57446	270	NG58214	282	NI57364	294	NM08574	319
ND66842	226	NE57448	271	NG58691	282	NI57385	295	NM08576	328
ND69830	231	NE59551	272	NG58692	282	NI57443	300	NM08850	326
ND69917	231	NE63564	272	NG59700	282	NI57525	297	NM09057	329
ND70435	237	NF01485	274	NG63193	286	NI57535	211	NM09535	304
ND70436	237	NF04076	280	NG74932	360	NI58200	296	NM09610	324
ND71063	231	NF04135	276	NH06266	288	NI61633	298	NM09702	317
ND71635	199	NF04428	280	NH08019	290	NI76867	297	NM09731	329
ND71638	199	NF04766	278	NH08020	290	NK06717	301	NM10203	324
ND71642	214	NF05140	274	NH08494	288	NK30244	301	NM10586	309
ND71643	207	NF06416	278	NH137506	289	NK76187	301	NM106396	326
ND71654	213	NF08012	279	NH137606	291	NK76188	301	NM10849	317
ND71658	214	NF08852	276	NH138533	289	NL01000	303	NM11441	314
ND71668	176	NF10198	276	NH15515	290	NL06295	302	NM11606	317
ND71669	206	NF11536	277	NH15525	291	NL06915	303	NM11612	313
ND71670	172	NF11636	275	NH15898	290	NL06916	303	NM11622	308
ND71671	224	NF137619	276	NH16032	288	NL15332	302	NM11623	308
ND71741	216	NF139015	275	NH32540	291	NL15940	302	NM13189	304
ND72055	235	NF146409	280	NH35521	289	NL24830	301	NM137573	328
ND72414	245	NF157285	280	NH44264	288	NL24831	302	NM137574	329
ND72433	169	NF16547	274	NH44934	290	NL27534	301	NM137575	328
ND74957	170	NF16548	279	NH57421	290	NL28880	302	NM137577	328
ND74958	170	NF16725	275	NH66985	290	NL30093	352	NM14086	323



# Product Code Index

NT57554

Product Code	Page	Product Code	Page	Product Code	Page	Product Code	Page	Product Code	Page
NM14093.....	321	NM57537.....	306	NP06253.....	344	NS15337.....	353	NT137586.....	362
NM14094.....	323	NM57538.....	307	NP06294.....	339	NS16562.....	354	NT137587.....	362
NM14097.....	321	NM58209.....	309	NP07291.....	340	NS16860.....	354	NT139052.....	368
NM14098.....	319	NM58210.....	314	NP07299.....	347	NS29828.....	353	NT145602.....	370
NM144522.....	323	NM58211.....	317	NP07357.....	340	NS30745.....	353	NT145606.....	372
NM144529.....	323	NM58212.....	326	NP08428.....	339	NS30746.....	353	NT145609.....	369
NM144826.....	323	NM59495.....	304	NP08579.....	342	NS45131.....	354	NT15541.....	368
NM157271.....	327	NM63223.....	329	NP08698.....	348	NS47205.....	354	NT15542.....	371
NM157272.....	309	NM63327.....	311	NP09203.....	346	NT00283.....	365	NT15543.....	370
NM157273.....	314	NM66689.....	321	NP09389.....	345	NT02592.....	365	NT156795.....	364
NM157274.....	318	NM67852.....	321	NP09419.....	339	NT02679.....	365	NT16126.....	364
NM157460.....	320	NM70420.....	320	NP11297.....	345	NT02881.....	361	NT16143.....	364
NM157477.....	313	NM71636.....	317	NP11710.....	344	NT02911.....	359	NT16564.....	356
NM157482.....	320	NM71637.....	309	NP11711.....	348	NT02914.....	361	NT16566.....	368
NM16314.....	307	NM71655.....	309	NP11733.....	341	NT02975.....	364	NT16567.....	371
NM16784.....	306	NM71656.....	309	NP140526.....	342	NT04379.....	363	NT16568.....	372
NM29024.....	324	NM71657.....	315	NP145591.....	343	NT04480.....	360	NT16569.....	374
NM29026.....	324	NM71742.....	325	NP157259.....	342	NT04548.....	369	NT16878.....	377
NM29027.....	324	NM71743.....	325	NP16241.....	345	NT04678.....	370	NT16879.....	370
NM29122.....	310	NM71847.....	306	NP28800.....	341	NT04884.....	376	NT20146.....	370
NM29278.....	154	NM71848.....	306	NP30541.....	343	NT05368.....	373	NT28569.....	369
NM29279.....	313	NM71849.....	307	NP30546.....	343	NT05401.....	374	NT29046.....	366
NM29280.....	314	NM71850.....	307	NP32608.....	348	NT05748.....	365	NT29258.....	373
NM29545.....	311	NM72044.....	324	NP44307.....	346	NT05775.....	369	NT29595.....	377
NM29546.....	311	NM76577.....	316	NP44590.....	342	NT06136.....	371	NT29596.....	377
NM29547.....	312	NN03322.....	335	NP45046.....	339	NT06137.....	373	NT29597.....	377
NM29548.....	312	NN07310.....	336	NP45047.....	339	NT06186.....	362	NT29608.....	361
NM29549.....	312	NN07313.....	335	NP46059.....	338	NT06341.....	361	NT29825.....	378
NM29550.....	312	NN08056.....	335	NP46144.....	340	NT06346.....	378	NT29841.....	362
NM29555.....	313	NN09410.....	335	NP46146.....	341	NT06665.....	378	NT29842.....	362
NM29588.....	311	NN09411.....	335	NP46568.....	341	NT06708.....	371	NT29843.....	363
NM29593.....	312	NN10871.....	332	NP46906.....	341	NT06907.....	372	NT29844.....	363
NM30233.....	325	NN10872.....	331	NP47204.....	344	NT07136.....	374	NT29845.....	363
NM30295.....	308	NN11350.....	336	NP57366.....	346	NT07155.....	368	NT29846.....	363
NM30298.....	308	NN11407.....	333	NP57370.....	347	NT07233.....	372	NT30283.....	367
NM32281.....	311	NN11481.....	331	NP57371.....	347	NT07343.....	371	NT30285.....	367
NM34075.....	307	NN11662.....	332	NP57376.....	347	NT07351.....	375	NT30288.....	367
NM35520.....	322	NN11969.....	333	NP57377.....	347	NT07359.....	362	NT30289.....	367
NM35522.....	319	NN12622.....	333	NP57381.....	346	NT07361.....	364	NT30291.....	368
NM36295.....	314	NN15304.....	331	NP57382.....	342	NT07601.....	360	NT30293.....	367
NM36299.....	307	NN15702.....	334	NP57387.....	347	NT07655.....	358	NT31833.....	355
NM44261.....	324	NN16559.....	330	NP57400.....	347	NT07958.....	370	NT32067.....	364
NM44265.....	305	NN16815.....	335	NP57408.....	340	NT07991.....	366	NT32262.....	364
NM44273.....	305	NN26176.....	331	NP57429.....	342	NT08058.....	366	NT32354.....	362
NM44304.....	316	NN26196.....	334	NP57432.....	345	NT08060.....	374	NT32421.....	369
NM44338.....	305	NN29116.....	332	NP57437.....	348	NT08062.....	378	NT34810.....	361
NM45525.....	306	NN31173.....	334	NP57439.....	346	NT08580.....	355	NT35287.....	361
NM46050.....	309	NN44827.....	333	NP57529.....	329	NT08581.....	355	NT36522.....	359
NM46051.....	314	NN44916.....	331	NP58309.....	345	NT08582.....	356	NT36523.....	359
NM46052.....	318	NN45059.....	334	NP63334.....	345	NT08583.....	355	NT44266.....	376
NM46053.....	327	NN45264.....	331	NP63439.....	345	NT08584.....	374	NT44267.....	355
NM46062.....	312	NN45265.....	332	NP66702.....	340	NT08585.....	372	NT44284.....	357
NM46113.....	316	NN45555.....	334	NR02712.....	350	NT08746.....	223	NT44794.....	375
NM46114.....	317	NN46649.....	334	NR04848.....	351	NT08796.....	375	NT44985.....	369
NM46468.....	325	NN47201.....	336	NR04851.....	349	NT08808.....	360	NT45806.....	373
NM46495.....	323	NN63886.....	336	NR04971.....	352	NT08812.....	365	NT46685.....	363
NM46513.....	320	NN64048.....	158	NR05251.....	351	NT08918.....	376	NT57363.....	369
NM46832.....	310	NO02817.....	338	NR07283.....	348	NT08919.....	377	NT57365.....	373
NM47199.....	303	NO05772.....	338	NR09650.....	349	NT08920.....	378	NT57413.....	358
NM47200.....	330	NO08048.....	338	NR09651.....	351	NT09632.....	371	NT57417.....	374
NM57378.....	324	NO10556.....	337	NR10396.....	349	NT09781.....	363	NT57436.....	358
NM57390.....	306	NO30948.....	68	NR10471.....	348	NT09943.....	375	NT57539.....	357
NM57392.....	325	NO47202.....	337	NR12804.....	349	NT09993.....	378	NT57540.....	358
NM57398.....	313	NO47203.....	337	NR145431.....	350	NT10016.....	368	NT57541.....	358
NM57401.....	321	NO63224.....	337	NR31832.....	352	NT10135.....	365	NT57542.....	94
NM57409.....	322	NO71879.....	338	NR32047.....	351	NT10156.....	372	NT57545.....	95
NM57412.....	308	NP00748.....	343	NR35410.....	350	NT10843.....	360	NT57546.....	132
NM57414.....	322	NP05471.....	343	NR46023.....	349	NT11483.....	359	NT57548.....	357
NM57430.....	307	NP06049.....	343	NR46024.....	349	NT11494.....	375	NT57549.....	357
NM57435.....	322	NP06202.....	343	NR63594.....	349	NT11637.....	34	NT57550.....	357
NM57442.....	307	NP06219.....	344	NR76131.....	350	NT11707.....	376	NT57551.....	357
NM57445.....	321	NP06233.....	344	NS139064.....	353	NT13491.....	363	NT57552.....	357
NM57493.....	328	NP06246.....	344	NS15336.....	353	NT137585.....	362	NT57554.....	20

Product Code	Page
NT57555 .....	20
NT57556 .....	356
NT57661 .....	359
NT58203 .....	366
NT58307 .....	373
NT59826 .....	376
NT61635 .....	356
NT67801 .....	375
NT71492 .....	360
NT76128 .....	373
NU02983 .....	380
NU03399 .....	380
NU03863 .....	381
NU04051 .....	382
NU04388 .....	381
NU05635 .....	379
NU05691 .....	381
NU06309 .....	382
NU07383 .....	380
NU07988 .....	382
NU10275 .....	381
NU12797 .....	380
NU16887 .....	380
NU16888 .....	380
NU30953 .....	379
NU30954 .....	379
NU34299 .....	155
NU34300 .....	156
NU35409 .....	381
NU46047 .....	382
NU46048 .....	382
NU46049 .....	382
NU58208 .....	381
NX02884 .....	384
NX09700 .....	384
NX143915 .....	384
NX28984 .....	383
NX31145 .....	383
NX65210 .....	384
NZ08027 .....	385
NZ30302 .....	385
NZ30326 .....	384
NZ30328 .....	385
NZ30353 .....	384



# Acyclic and Cyclic Aldoses

# Acyclic Forms of α-D-Aldoses

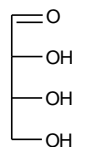
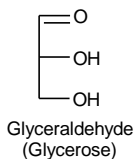

Erythrose

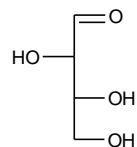

Threose

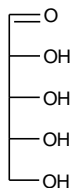

Ribose

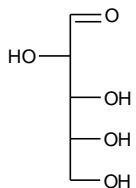

Arabinose

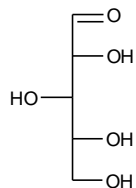

Xylose

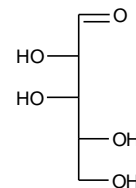

Lyxose

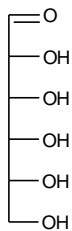

Allose

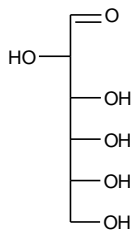

Altrose

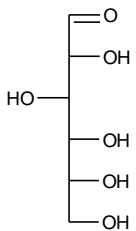

Glucose

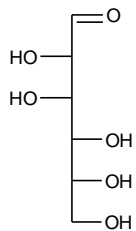

Mannose

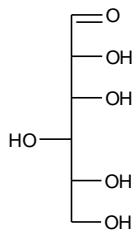

Gulose

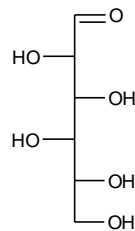

Idose

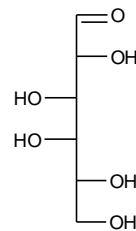

Galactose

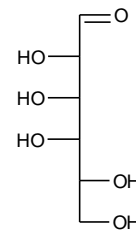

Talose

# Cyclic Forms of α-D-Aldoses

Threose

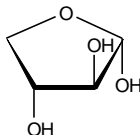

Xylofuranose

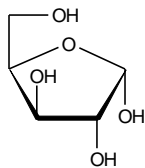

Lyxofuranose

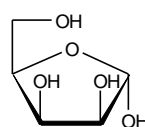

Xylopyranose

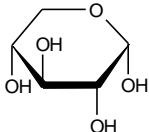

Lyxopyranose

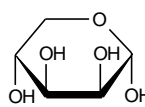

Gulofuranose

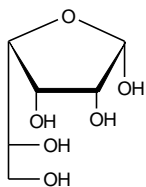

Idofuranose

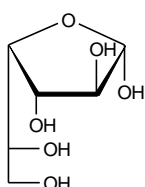

Galactofuranose

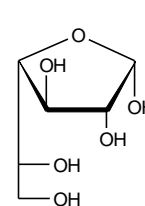

Talofuranose

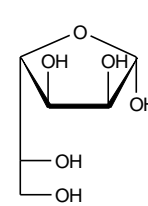

Gulopyranose

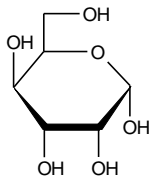

Idopyranose

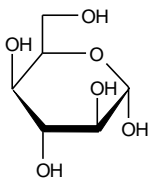

Galactopyranose

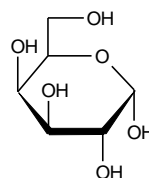

Talopyranose

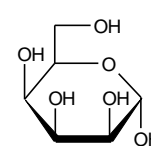

# Cyclic Forms of α-D-Aldoses

Erythrose

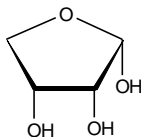

Ribofuranose

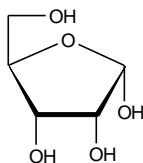

Arabinofuranose

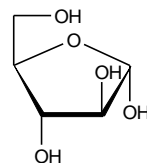

Ribopyranose

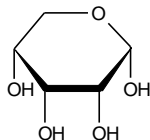

Arabinopyranose

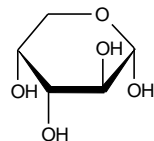

Allofuranose

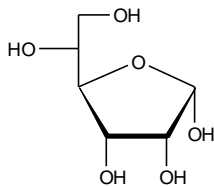

Altrofuranose

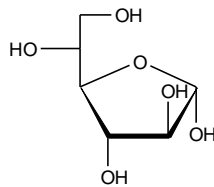

Glucufuranose

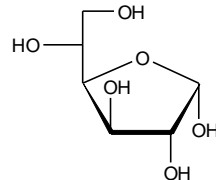

Mannofuranose

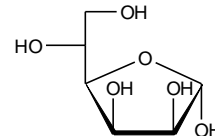

Allopyranose

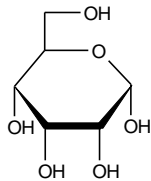

Altropyranose

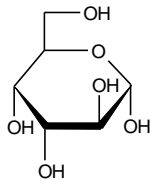

Glucopyranose

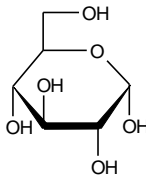

Mannopyranose

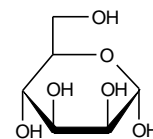



# Ring Numbering System

# Ring Numbering System

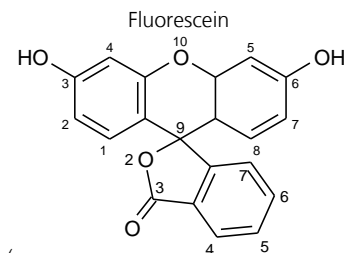
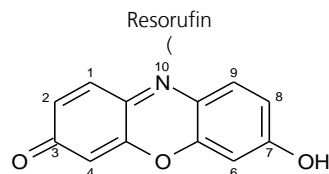
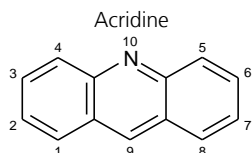
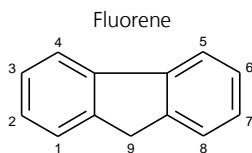
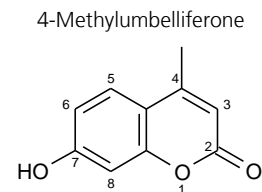
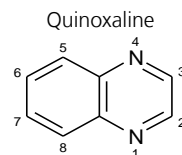
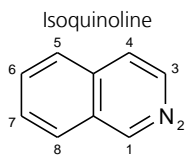
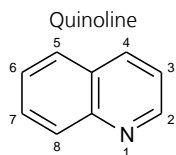
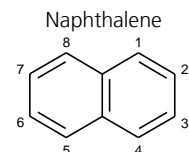
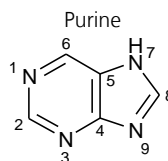
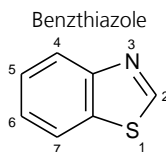
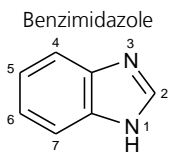
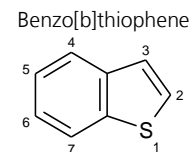
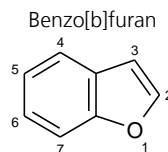
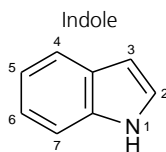
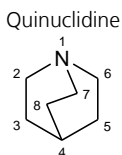
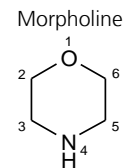
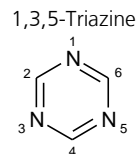
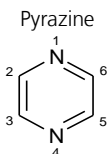
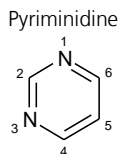
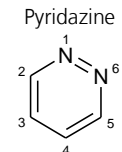
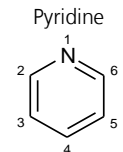
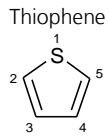
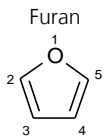



# Catalogue Abbreviations

\$	United States Dollars	Fru	Fructose	ManNAc	N-Acetyl-mannosamine
£	United Kingdom Pounds	Fuc	Fucose	MCe	Methyl cellulose
€	Euros	FucN	Fucosamine	Me	Methyl group
a	Alpha	FucNac	N-Acetyl-fucosamine	Mel	Methiodide
Ac	Acetyl	FW	Formula weight calculated using C mass 12.0107 and including hydrates if known	mg	Milligram
AdNJ	2-Acetamido-1,2-dideoxynojirimycin	G	Gram	ug	Microgram
ADR	European Agreement concerning the International Carriage of Dangerous goods by Road	GAG	Glycosaminoglycan	MMT	Monomethoxytrityl
Alt	Altrose	Gal	Galactose	Ms	Methanesulfonyl
APD	Acetylphenylenediamine	GalA	Galacturonic acid	MTS	Methanethiosulfonyl
APE	Aminophenylethyl	GalNAc	N-Acetylgalactosamine	MU	Methylumbelliferyl
API	Active Pharmaceutical Ingredient	GDP	Guanosine 5'-diphosphate	n	Normal
Ara	Arabinose	Glc	Glucose	NAG	N-Acetyl-glucosamine
ATP	Adenosine 5'-triphosphate	GlcA	Glucuronic acid	NANA	N-Acetyl neuraminic acid
AZT	Azidothymidine	GlcN	Glucosamine	NAO	Non-animal origin
b	Beta	GlcNAc	N-Acetylglucosamine	Neu	Neuraminic acid
Bn	Benzyl	Gul	Gulose	Neu5Ac	N-Acetyl neuraminic acid
Boc	tert-Butoxycarbonyl	GulA	Guluronic acid	ONP	2-Nitrophenyl
BSA	Bovine serum albumin	HEC	Hydroxyethyl cellulose	ONPG	2-Nitrophenyl-b-D-galactopyranoside
Bz	Benzoyl	HM	High methoxy	Ots	p-Toluenesulfonyl
ca.	approximately	HPC	Hydroxypropyl cellulose	PAP	p-Aminophenyl
CAP	Cellulose acetate phthalate	HPLC	High-performance liquid chromatography	PGX	Polyglycoplex
CAS	Chemical Abstracts Service (Registry Number)	HPMC	Hydroxypropylmethyl cellulose	PMB	Anisoyl
CMC	Carboxymethyl cellulose	HPMCP	Hydroxypropylmethyl cellulose phthalate	PNP	4-Nitrophenyl
CM-Dextran	Carboxymethyl dextran	HSA	Human serum albumin	PugNAc	O-(2-Acetamido-2-deoxy-D-glucopyranosylidene)amine N-phenyl carbamate
CUG	Carboxyumbelliferyl galactopyranoside	i	Iota	Rha	Rhamnose
DEAE-Dextran	Diethylaminoethyl dextran	Ido	Idose	Rib	Ribose
DIC	1,3-Diisopropylcarbodiimide	IdoA	Iduronic acid	ROW	Rest of World
DMF	Dimethylaminomethylidene	Ino	Inositol	Sol	Solution
DMT	Dimethoxytrityl	IPTG	Isopropyl b-D-1-thiogalactopyranoside	Sor	Sorbose
E	trans	k	Kappa	Tag	Tagatose
EC	European Commission	Kg	Kilogram	Tal	Talose
ECe	Ethyl cellulose	KLH	Keyhole limpet hemocyanin	TBDMS	tert-Butyldimethyl silyl
EHC	Ethyl hydroxyethyl cellulose	l	Lambda	t-Bu	tert-Butyl
EINECS	European Inventory of Existing Commercial Chemical Substances	LacNAc	N-Acetyl-lactosamine	Tol	Tolyl
ELINCS	European List of Notified Chemical Substances	LM	Low methoxy	Tr	Trityl
Et	Ethyl group	LogNAc	2-Acetamido-2-deoxy-D-glucohydroximo-1,5-lactone	UDP	Uridine 5'-diphosphate
Et3N	Triethyl amine	Lyx	Lyxose	UN Number	United Nations Substance Identification Number
EUR	Euros	Man	Mannose	WSC	Water-soluble carbodiimide
EXW	Ex works	ManA	Mannurinic acid	Xyl	Xylose
Fmoc	Fluorenylmethoxycarbonyl	ManN	Mannosamine	Z	cis

# Journal Abbreviations

Acc. Chem. Res.	Accounts of Chemical Research	Biosci. Rep.	Bioscience Reports
Acta. Crystallogr. Sect. A	Acta Crystallographica Section A: Foundations	Biotechnol. Appl. Biochem.	Biotechnology and Applied Biochemistry
Acta. Crystallogr. Sect. B	Acta Crystallographica Section A: Foundations	Biotechnol. Bioeng.	Biotechnology and Bioengineering
Acta. Crystallogr. Sect. C	Acta Crystallographica Section C: Crystal Structure Communications	Biotechnol. Lett.	Biotechnology Letters
Acta. Crystallogr. Sect. D	Acta Crystallographica Section D: Biological Crystallography	Br. J. Pharmacol.	British Journal of Pharmacology
Acta. Crystallogr. Sect. E	Acta Crystallographica Section E: Structure Reports Online	Bull. Korean Chem. Soc.	Bulletin of the Korean Chemical Society
Adv. Synth. Catal.	Advanced Synthesis and Catalysis	Can. J. Biochem.	Canadian Journal of Biochemistry
Anal. Biochem.	Analytical Biochemistry	Can. J. Chem.	Canadian Journal of Chemistry
Anal. Chim. Acta	Analytica Chimica Acta	Carbohydr. Chem	Carbohydrate Chemistry
Angew. Chem. Int. Ed.	Angewandte Chemie International Edition	Carbohydr. Res.	Carbohydrate Research
Antimicrob. Agents Chemother.	Antimicrobial Agents and Chemotherapy	Cell Biochem. Funct.	Cell Biochemistry and Function
Antiviral Chem. Chemother.	Antiviral Chemistry and Chemotherapy	Chem. Ber.	Chemische Berichte
Appl. Compos. Mater.	Applied Composite Materials	Chem. Commun.	Chemical Communications
Appl. Environ. Microbiol.	Applied and Environmental Microbiology	Chem. Eur. J.	Chemistry - A European Journal
Appl. Microbiol. Biotechnol	Applied Microbiology and Biotechnology	Chem. Heterocycl. Compd.	Chemistry of Heterocyclic Compounds
Arch. Biochem. Biophys.	Archives of Biochemistry and Biophysics	Chem. Nat. Compd.	Chemistry of Natural Compounds
Arch. Environ. Contam. Toxicol.	Archives of Environmental Contamination and Toxicology	Chem. Pharm. Bull.	Chemical and Pharmaceutical Bulletin
Arch. Microbiol.	Archives of Microbiology	Chem. Phys. Lipids	Chemistry and Physics of Lipids
Biochem. Biophys. Res. Commun.	Biochemical and Biophysical Research Communications	Chem. Res. Toxicol.	Chemical Research in Toxicology
Biochem. J.	Biochemical Journal	Chem. Rev.	Chemical Reviews
Biochem. Pharmacol.	Biochemical Pharmacology	Chin. Chem. Lett.	Chinese Chemical Letters
Biochim. Biophys. Acta	Biochimica et Biophysica Acta	Clin. Biochem.	Clinical Biochemistry
Biomed. Chromatogr.	Biomedical Chromatography	Clin. Chim. Acta	Clinica Chimica Acta
Bioorg. Med. Chem.	Bioorganic and Medicinal Chemistry	Collect. Czech. Chem. Commun.	Collection of Czechoslovak Chemical Communications
Bioorg. Med. Chem. Lett.	Bioorganic and Medicinal Chemistry Letters	Enzyme Microb. Technol.	Enzyme and Microbial Technology
Biophys. Chem.	Biophysical Chemistry	Eur. J. Biochem.	European Journal of Biochemistry
Biophys. J.	Biophysical Journal	FEBS Lett.	FEBS Letters
Biosci. Biotechnol. Biochem.	Bioscience Biotechnology and Biochemistry	Free Radical Biol. Med.	Free Radical Biotechnology and Medicine
		Fresenius J. Anal. Chem.	Fresenius Journal of Analytical Chemistry
		Glycoconjugate J.	Glycoconjugate Journal
		Helv. Chim. Acta	Helvetica Chimica Acta
		Indian J. Chem. Sect. A	Indian Journal of Chemistry Section A
		Indian J. Chem. Sect. B	Indian Journal of Chemistry Section B

# Journal Abbreviations

Inorg. Chem.	Inorganic Chemistry	Macromol. Chem. Phys.	Macromolecular Chemistry and Physics
Int. J. Chem. Kinet.	International Journal of Chemical Kinetics	Mendeleev Commun.	Mendeleev Communications
Int. J. Polym. Mater.	International Journal of Polymeric Materials	Methods Enzymol.	Methods in Enzymology
Int. J. Radiat. Biol.	International Journal of Radiation Biology	Mikrochim. Acta	Mikrochimica Acta
J. Am. Chem. Soc.	Journal of the American Chemical Society	Mol. Cell. Biochem.	Molecular and Cellular Biochemistry
J. AOAC Int.	Journal of AOAC International	Mol. Microbiol.	Molecular Microbiology
J. Appl. Polym. Sci.	Journal of Applied Polymer Science	Mol. Pharmacol.	Molecular Pharmacology
J. Bacteriol.	Journal of Bacteriology	Mol. Phys.	Molecular Physics
J. Biol. Chem.	Journal of Biological Chemistry	Nat. Biotechnol.	Nature Biotechnology
J. Biomed. Mater. Res.	Journal of Biomedical Materials Research	Nucleic Acids Res.	Nucleic Acids Research
J. Carbohydr. Chem.	Journal of Carbohydrate Chemistry	Org. Lett.	Organic Letters
J. Cell. Biochem.	Journal of Cellular Biochemistry	Org. Mass Spectrom.	Organic Mass Spectrometry
J. Chem. Ecol.	Journal of Chemical Ecology	Pharm. Chem. J.	Pharmaceutical Chemistry Journal
J. Chem. Soc. Chem. Commun.	Journal of the Chemical Society, Chemical Communications	Photochem. Photobiol.	Photochemistry and Photobiology
J. Chem. Soc. Perkin Trans. 1	Journal of the Chemical Society, Perkin Transactions 1	Polym. Adv. Technol.	Polymers for Advanced Technology
J. Chem. Soc. Perkin Trans. 2	Journal of the Chemical Society, Perkin Transactions 2	Reel. Trav. Chim. Pays-Bas	Recueil des Travaux Chimiques des Pays-Bas Journal
J. Chromatogr.	Journal of Chromatography	Russ. Chem. Bull.	Russian Chemical Bulletin
J. Ferment Bioeng.	Journal of Fermentation and Bioengineering	Synth. Commun.	Synthetic Communications
J. Ind. Microbiol. Biotechnol.	Journal of Industrial Microbiology and Biotechnology	Tetrahedron Lett.	Tetrahedron Letters
J. Mass Spectrom.	Journal of Mass Spectrometry	Tetrahedron: Asymmetry	Tetrahedron: Asymmetry
J. Med. Chem.	Journal of Medicinal Chemistry		
J. Membr. Biol.	Journal of Membrane Biology		
J. Membr. Sci.	Journal of Membrane Science		
J. Org. Chem.	Journal of Organic Chemistry		
J. Pharm. Sci.	Journal of Pharmaceutical Sciences		
J. Pharmacol. Exp. Ther.	Journal of Pharmacology and Experimental Therapeutics		
J. Polym. Sci. Part A: Polym. Chem.	Journal of Polymer Science Part A: Polymer Chemistry		
J. Polym. Sci. Part B: Polym. Phys.	Journal of Polymer Science Part B: Polymer Physics		
Liebigs Ann. Chem.	Liebigs Annalen der Chemie		

# Carbosynth



Bulk Manufacture of **EDC**

## Water Soluble Carbodiimide

1-(3-Dimethylaminopropyl)-3-ethylcarbodiimide hydrochloride, usually known as water soluble carbodiimide, EDC, EDAC or WSC (product code FD05800) is a versatile modern coupling agent. It is an easily handled solid with high solubility in water ( $> 200\text{g l}^{-1}$ ) and organic solvents such as dichloromethane, tetrahydrofuran and dimethylformamide.

EDC is often preferred to dicyclohexylcarbodiimide (DCC) in peptide synthesis because of its ease of handling and the enhanced solubility of EDC and the urea by-product formed during the coupling reaction. The urea by-product is readily soluble in water and can easily be removed by extraction whereas the DCC by-product, dicyclohexylurea, is usually removed by multiple filtrations.

EDC can be used in a wide range of solvents and under mild conditions. The most common reaction conditions involve a solvent such as water, dichloromethane, tetrahydrofuran or dimethylformamide at room temperature for 6 -12 hrs. The coupling of an acid to an amine to form a peptide bond in the presence of EDC proceeds via an O-acylisourea intermediate as shown below (Scheme 1).

Scheme 1

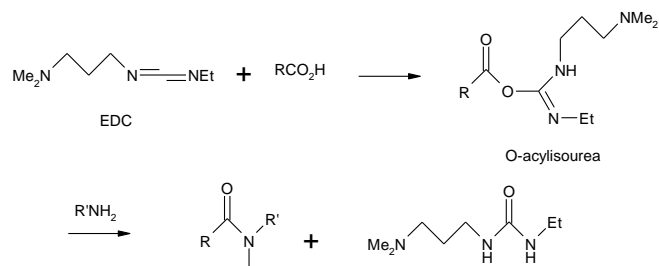

As well as being used for the synthesis of amides, EDC is also used as a coupling agent in the preparation of esters from carboxylic acids using dimethylaminopyridine as the catalyst. This procedure has been used to prepare tert-butyl esters of N-protected amino acids.<sup>2</sup>

The oxadiazole ring system (which is present in a range of pharmaceutical active products) has been synthesised using EDC to couple a carboxylic acid group to form the ring. This procedure has the advantage over other methods in that carboxylic acids are readily available and this procedure is compatible with a variety of functional groups (Scheme 2).<sup>3</sup>

Although EDC can be used for reactions in aqueous solution it is usually stored under dry conditions to prevent slow hydrolysis to the corresponding urea. EDC is not a strong skin sensitiser like DCC, but it is an irritant solid and should be handled with care.

Scheme 2

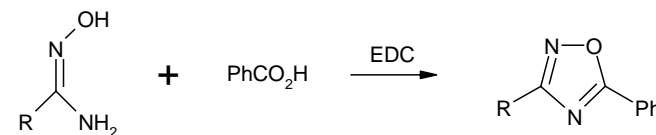

### References:

1. JC Sheehan, J Preston, PA Cruickshank, J. Am. Chem. Soc., 1965, 87, 2492.
2. MK Dhaon, RK Olsen, K. Ramasamy, J. Org. Chem, 1982, 47, 1962.
3. G-B Ling, DD Feng, Tetrahedron Lett, 1996, 37, 6627

# Carbosynth



The Source for **Carbohydrates and Nucleosides**

## Fluorination Technology

Fluorinated organic compounds have attracted wide interest in drug discovery due to the fluorine's small size (similar to hydrogen), the stable carbon-fluorine bond and its electronegativity. Carbosynth has developed expertise in fluorination of carbohydrates and nucleosides and this technology has been successfully applied at both lab and plant scale.

### Monosaccharides

Our fluorination technology has been used to make the following types of monosaccharide

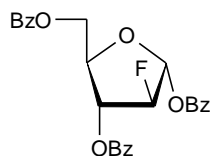

1,3,5-Tri-O-benzoyl-2-deoxy-2-fluoro- $\alpha$ -D-arabinofuranose (MT04218)

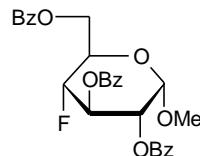

Methyl 2,3,6-tri-O-benzoyl-4-deoxy-4-fluoro- $\alpha$ -D-glucopyranoside (MM06982)

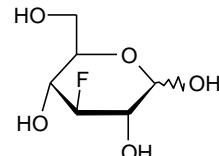

3-Deoxy-3-fluoro-D-glucose (MD05769)

### Nucleosides and Bases

We have extended our technology to nucleosides and nucleoside bases, a few of which are listed here:

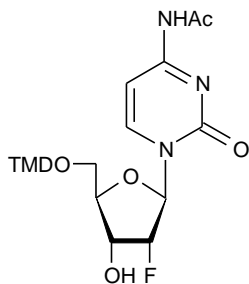

N4-Acetyl-2'-deoxy-5'-O-DMT-2'-fluoro-D-cytidine (NA06052)

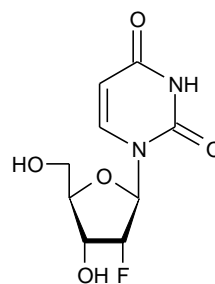

2'-Deoxy-2'-fluoro-D-uridine (ND06544)

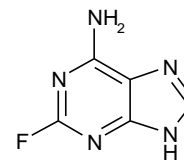

2-Fluoroadenine (FF05946)

# Terms of Sale

## Application

These terms and conditions apply to all sales of goods by the Seller to any Purchaser (Buyer) and shall prevail over and apply to the exclusion of any terms or conditions contained or referred to in the Buyer's order or in correspondence or elsewhere or implied by trade custom or dealing unless specifically agreed to in writing by a director or other authorised representative of the Seller and any purported provisions to the contrary are hereby excluded or extinguished.

## Definitions

"Seller" means Carbosynth Limited (registration number 5771788)

"Products" "Goods" means the items described in the orders to be supplied by Carbosynth to the Buyer pursuant to this Agreement

"Buyer" "Purchaser" means the other party to this agreement

## Quotations

A quotation by the Seller does not constitute an offer and may be withdrawn or revised at any time prior to the Seller's acceptance of the Buyer's order.

## Prices

**(A)** The prices payable for the goods shall be those contained in the Seller's list prices that is current at the time of despatch. The Seller shall have the right at any time to withdraw any discount from its normal prices and/or to revise prices to take into account increases in costs including without limitation costs of any goods, materials, carriage, labour or overheads, the increase or imposition of any tax, duty or other levy and any variation in exchange rates.

**(B)** Unless otherwise specified VAT and any other tax or duties payable by the Buyer shall be added to the price.

## Terms of Payment

**(A)** Payment of invoices, unless subject to the terms and conditions under "Export Sales", shall unless otherwise agreed in writing be made in full without any deduction or set-off within 30 days of the date of invoice.

**(B)** Any extension of credit allowed to the Buyer may be changed or withdrawn at any time

**(C)** Interest shall be payable on overdue accounts at the rate of 3% over Royal Bank of Scotland Plc base rate to run from the due date for payment thereof until receipt by the Seller of the full amount whether or not after judgement.

## Delivery

**(A)** Delivery dates mentioned in any quotation, acknowledgement of order or elsewhere are approximate only and not of any contractual effect and the Seller shall not be under any liability to the Buyer in respect of any failure to deliver on any particular date or dates.

**(B)** Delivery shall be at the Buyer's premises unless otherwise stipulated or agreed by the Seller. The Seller may charge for delivery other than at its premises.

**(C)** If the Buyer refuses or fails to take delivery of goods tendered in accordance with the contract the Seller shall be entitled to immediate payment in full for the goods so tendered. The Seller shall be entitled to store at the risk of the Buyer any goods of which the Buyer refuses or fails to take delivery and the Buyer shall in addition to the purchase price pay all costs of such storage and any additional costs incurred as a result of such refusal or failure. The Seller shall be entitled after the expiration of 3 months from the date upon which the price became payable to dispose of the goods in such manner as the Seller may determine.

## Divisibility

Each delivery made hereunder shall be deemed to arise from a separate contract and shall be invoiced separately; any invoice for a delivery shall be payable in full in accordance with the terms of payment provided for herein, without reference to and notwithstanding any defect of default in delivery of any other instalment.

## Risk

Subject (where appropriate) to the terms and conditions under "Export Sales" shall pass on delivery.

## Export Sales

**(A)** In the case where the goods are sold CIF or FOB or on the basis of other international trade term the meaning of such term contained in incoterms as revised from time to time shall apply except where inconsistent with any of the provisions contained in these Conditions.

**(B)** Unless otherwise agreed the price of the goods shall be secured by an irrevocable Letter of Credit satisfactory to the Seller established by the Buyer in favour of the Seller immediately upon receipt of the Seller's acknowledgement of order and confirmed by a United Kingdom bank acceptable to the Seller. The letter of credit shall be for the contract price inclusive of any tax or duty payable by the Buyer and shall be valid for at least 6 months or such longer period as shall have been estimated by the Seller for delivery. The Seller shall be entitled to payment on presentation to such United Kingdom bank of the documents specified by the Seller or as herein stipulated.

**(C)** Should the Buyer fail when requested by the Seller and within the time specified by the Seller to take any action necessary on its part for delivery and/or shipment of the goods then (i) The Seller shall be entitled by way of delivery to store the goods in a warehouse at the expense and risk of the Buyer (ii) The price shall become immediately payable (iii) If payment is secured by a Letter of Credit the Seller shall be entitled to payment on presentation of the copy sales

# Terms of Sale

invoice and the warehouse receipt and (iv) The Seller shall be entitled after the expiration of 3 months from the date upon which the price became payable to dispose of the goods in such manner as the Seller may determine without accounting to the Buyer therefore:

**(D)** Section 32(2) of the Sale of Goods Act 1979 shall not apply. The Seller shall not be required to give the Buyer the notice specified in Section 32(3) of that Act.

## Title

**(A)** Title to the goods shall not pass to the Buyer until the earlier of: payment in full of the price or the goods ceasing to be identifiable by virtue of their utilisation or consumption in the production of other items or materials. Until such payment, utilisation or consumption the Buyer shall have possession of the goods as bailee for the Seller and shall store the goods in such a way as to enable them to be identifiable as the property of the Seller provided that if the Buyer is purchasing the goods for resale the Buyer may in the ordinary course of its business sell and deliver the goods to a third party on condition that until such payment as aforesaid the Buyer shall hold all proceeds of such sale in trust for the Seller and in a separate account. The Buyer hereby undertakes forthwith upon being so requested by the Seller to assign to the Seller all rights and claims which the Buyer may have against its customers arising from such sales until payment is made in full as aforesaid.

**(B)** The Seller reserves the right to repossess any identifiable goods in respect of which payment is overdue and thereafter to re-sell the same and for this purpose the Buyer grants an irrevocable right and licence to the Seller's servants and agents to enter upon all or any of its premises with or without vehicles during normal business hours. This right shall continue to subsist notwithstanding the termination of the contract for any reason and is without prejudice to any accrued rights of the Seller there under or otherwise.

## Variation

The Seller shall be determined to have fulfilled its contractual obligations in respect of any delivery though the quantity may be up to 10% more or less than the quantity specified in the contract and in such event the Buyer shall pay for the actual quantity delivered.

## Third Party Rights

**(A)** The Buyer shall indemnify the Seller against any and all liabilities, claims and costs incurred by or made against the Seller as a direct or indirect result of the carrying out of any work required to be done on or to the goods in accordance with the requirements or specifications of the Buyer involving any infringement or alleged infringement of any rights of any third party.

**(B)** The Seller shall have no liability to the Buyer in the event of the goods infringing or being alleged to infringe the rights of any third party. In the event that the goods are or may be the subject of patent, copyright, registered design, trade mark or other rights of any third party the Seller shall be obliged to transfer to the Buyer only such title as the Seller may have.

## Specifications

Unless expressly agreed in writing by the Seller all data sheets, specifications and particulars of physical properties submitted by the Seller are approximate only and the Seller shall have no liability in respect of any deviation therefrom. The Seller accepts no responsibility for any errors, omissions or other defects in any data sheets, specifications or particulars of physical properties not prepared by the Seller and the Seller shall be indemnified by the Buyer against any and all liabilities and expenses incurred by the Seller arising therefrom.

## Liability

**(A)** The Seller shall not be liable to the Buyer (i) For shortages in quantity delivered unless the Buyer notifies the Seller of any claim of short delivery within 7 days of receipt of goods (ii) Where goods are carried by the Seller's own transport or by a carrier on

behalf of the Seller for damage in transit to the goods apparent upon a reasonable inspection or loss in transit of the goods or any part thereof unless the Buyer shall notify the Seller of any such claim within 14 days of receipt of the goods or the scheduled date of delivery whichever shall be the earlier (iii) For defects in the goods caused by any act, neglect or default of the Buyer or of any third party. (iv) For other defects in the goods unless notified to the Seller within 14 days of receipt of the goods by the Buyer or where the defect would not be apparent on reasonable inspection within 3 months of delivery.

**(B)** The Seller may at its option make good any shortage or non-delivery and/or as appropriate replace any goods found to be damaged or defective.

**(C)** The Seller's aggregate liability to the Buyer whether for negligence, breach of contract, misrepresentation or otherwise shall in no circumstances exceed the cost of the defective damaged or under delivered goods determined by net price invoiced to the Buyer in respect of any occurrence or series of occurrences.

**(D)** The Seller's prices are determined on the basis of the limits of liability set out in this Condition. The Buyer may by written notice to the Seller request the Seller to agree a higher limit of liability provided insurance cover can be obtained therefore. The Seller shall effect insurance up to such limit and the Buyer shall pay upon demand the amount of any and all premiums. The Buyer shall disclose such information as the insurer shall require. In no case shall the Buyer be entitled to recover from the Seller more than the amount received from the insurers.

**(E)** Without prejudice to any other provisions herein where a shelf life is specified for the goods (in any relevant data sheet or other document available to the Buyer) the Seller shall have no liability for any degradation to the goods after the expiry of such shelf life and for any resulting loss to the Buyer and any other person, firm or company

# Terms of Sale

**(F)** Subject to the foregoing all conditions, warranties and representations expressed or implied by statute, common law or otherwise in relation to the goods are hereby excluded and the Seller shall be under no liability to the Buyer for any loss, damage or injury direct or indirect resulting from defective material, faulty workmanship or otherwise howsoever arising and whether or not caused by the negligence of the Seller, its employees or agents SAVE THAT the Seller shall accept liability for death or personal injury caused by the negligence of the Seller.

## Packaging

**(A)** The Buyer shall meet the cost of any special packaging requested by the Buyer for any packaging rendered necessary by delivery by any means other than the Seller's normal means of delivery.

**(B)** The Seller shall be entitled to invoice the Buyer for the cost of all pallets and other returnable packaging materials unless the same are returned to the Seller in good condition carriage paid within 30 days of the date of delivery.

## Licences and Consents

If any licence or consent of any government or other authority shall be required for the acquisition, carriage or use of the goods by the Buyer the Buyer shall obtain the same at its own expense and if necessary produce evidence of the same to the Seller on demand. Failure to do so shall not entitle the Buyer to withhold or delay payment of the price. Any additional expenses or charges incurred by the Seller resulting from such failure shall be for the Buyer's account.

## Force Majeure

**(A)** The Seller shall not be liable to the Buyer for any loss or damage which may be suffered by the Buyer as a direct or indirect result of the supply of goods by the Seller

being prevented, hindered, delayed or rendered uneconomic by reason of circumstances or events beyond the Seller's reasonable control including but not limited to act of God, war, riot, strike, lock-out, trade dispute or labour disturbance, accident, breakdown of plant or machinery, fire, flood, storm, difficulty or increased expense in obtaining workmen, materials or transport or other circumstances affecting the supply of the goods or of raw materials therefore by the Seller's normal source of supply or the manufacture of the goods by the Seller's normal means or the delivery of the goods by the Seller's normal route or means of delivery

**(B)** If due to such events or circumstances the Seller has insufficient stocks to meet all its commitments the Seller may apportion available stocks between its customers at its sole discretion.

## Insolvency and Default

If the Buyer makes any voluntary arrangement with its creditors or becomes subject to an administration order or permits an act of bankruptcy or compounds with his creditors or if a receiving order is made against him or if (being a company) an order is made or a resolution is passed for the winding up of the Buyer (otherwise than for the purpose of amalgamation or reconstruction) or if a receiver is appointed of any of the Buyer's assets or undertaking or if circumstances arise which entitle the court or a creditor to appoint a receiver or manager or which entitle the court to make a winding up order or if the Buyer takes or suffers any similar or analogous action in consequence of debt or commits any breach of this or any other contract between the Seller and the Buyer the Seller may without prejudice to any of its other rights stop any goods in transit and/or suspend further deliveries and/or determine the rights of the Buyer under condition 8 and/or by notice in writing to the Buyer determine the contract.

## Waiver

Failure by the Seller to exercise or enforce any rights hereunder shall not be deemed to be a waiver of any such right nor operate so as to bar the exercise or enforcement thereof at any time or times thereafter.

## Notices

Any notice hereunder shall be deemed to have been duly given if sent by registered post, personal delivery, telex, fax or e-mail to the party concerned at its last known address. Notices sent by registered post shall be deemed to have been given 7 days after despatch and notices sent by telex, fax or e-mail shall be deemed to have been given on the date of despatch. Notices given by personal delivery shall be deemed to be given on delivery.

## Governing Law

This contract shall be governed by and construed in all respects in accordance with the laws of England and the parties hereby submit to the jurisdiction of the English court.

## Health and Safety

The Seller provides Material Safety Data Sheets on request, in accordance with current legislation; the goods supplied are for supply to qualified personnel only. The goods should be used in facilities designed for chemical, biological and allied research only and not for human or animal consumption. Goods should be stored in accordance with details provided on the Material Safety Data Sheet and labels. Precautions should be taken to ensure that contact between goods and skin, eyes or other mucous membranes is avoided using where necessary protective clothing and air extraction.



# 進階生物科技股份有限公司

台北總公司 02-26959935  
台中辦事處 04-22373160

免付費專線 0800251302  
台南辦事處 06-2760235

傳真 02-26958373  
高屏台東辦事處 07-5539956

新竹辦事處 03-5640901

經銷商 榮陽長庚區·康寧 02-28200822

[www.level.com.tw](http://www.level.com.tw)